

CERTIFICATE

Certified Passive House Component

Component-ID 0951wi03 valid until 31st December 2017

Passive House Institute
Dr. Wolfgang Feist
64283 Darmstadt
Germany

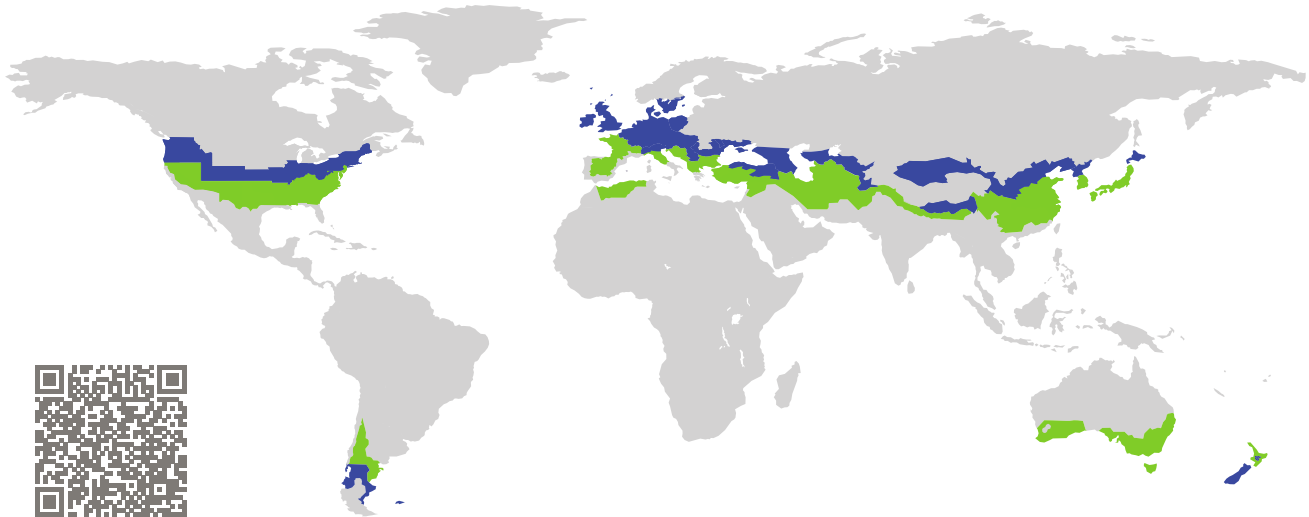

Category: **Window frame**
Manufacturer: **EnVision Systems (Shanghai) Co.,Ltd, Shanghai, People's Republic of China**
Product name: **WS86**

This certificate was awarded based on the following criteria for the cool, temperate climate zone

Comfort $U_W = 0.78 \leq 0.80 \text{ W}/(\text{m}^2 \text{ K})$
 $U_{W,\text{installed}} \leq 0.85 \text{ W}/(\text{m}^2 \text{ K})$
with $U_g = 0.70 \text{ W}/(\text{m}^2 \text{ K})$

Hygiene $f_{Rsi=0.25} \geq 0.70$

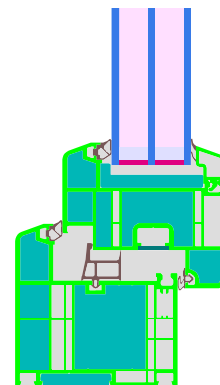

cool, temperate climate



CERTIFIED COMPONENT

Passive House Institute

Passive House
efficiency class

phE

phD

phC

phB

phA

www.passivehouse.com

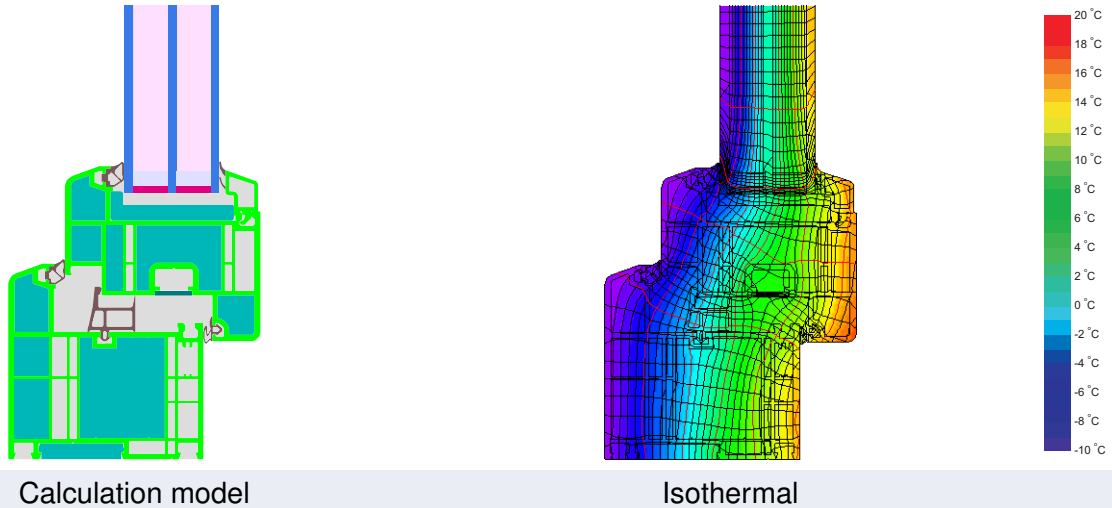

Calculation model Isothermal

Description

PVC Frame,insulated by EPS-Foam(0.035 W/(mK)). Pane thickness: 42 mm (4/15/4/15/4), rebate depth: 12 mm, spacer: SWISSPACER Ultimate with silicone secondary seal.

Explanation





The window U-values were calculated for the test window size of 1.23 m × 1.48 m with $U_g = 0.70$ W/(m² K). If a higher quality glazing is used, the window U-values will improve as follows:

Glazing	$U_g =$	0.70	0.66	0.62	0.58	W/(m ² K)
		↓	↓	↓	↓	
Window	$U_W =$	0.78	0.76	0.73	0.70	W/(m ² K)

Transparent building components are classified into efficiency classes depending on the heat losses through the opaque part. The frame U-Values, frame widths, thermal bridges at the glazing edge, and the glazing edge lengths are included in these heat losses. A more detailed report of the calculations performed in the context of certification is available from the manufacturer.

The Passive House Institute has defined international component criteria for seven climate zones. In principle, components which have been certified for climate zones with higher requirements may also be used in climates with less stringent requirements. In a particular climate zone it may make sense to use a component of a higher thermal quality which has been certified for a climate zone with more stringent requirements.

Further information relating to certification can be found on www.passivehouse.com and passipedia.org.

Frame values			Frame width b_f mm	U -value frame U_f W/(m ² K)	Ψ -glass edge Ψ_g W/(m K)	Temp. Factor $f_{Rsi=0.25}$ [-]
Top	(to)		129	0.75	0.027	0.73
Side	(s)		129	0.75	0.027	0.73
Bottom	(bo)		129	0.75	0.027	0.73
Mullion 2 casements	(m2)		184	0.81	0.028	0.72
			Spacer: SWISSPACER Ultimate		Secondary seal: Silicone	

Validated installations

