

CERTIFICATE

Certified Passive House Component

Component-ID 0963cw03 valid until 31st December 2017

Passive House Institute
Dr. Wolfgang Feist
64283 Darmstadt
Germany

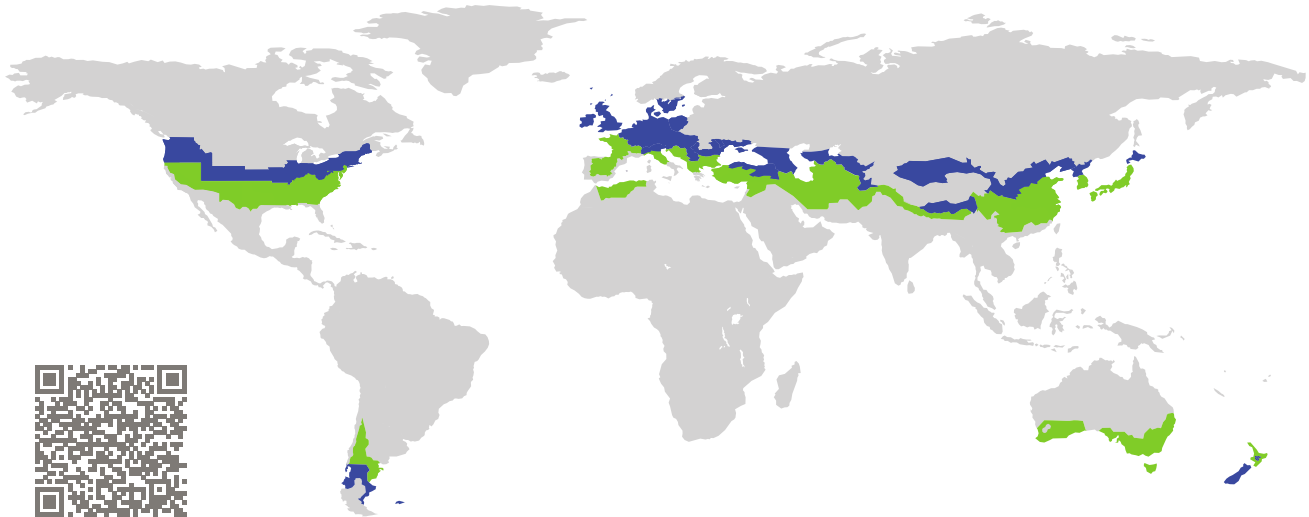

Category: **Curtain Wall**
Manufacturer: **Forster Profilsysteme AG,
Arbon,
Switzerland**
Product name: **forster thermfix® vario Hi 45 mm**

**This certificate was awarded based on the following
criteria for the cool, temperate climate zone**

Comfort $U_{CW} = 0.80 \leq 0.80 \text{ W}/(\text{m}^2 \text{ K})$
 $U_{CW, \text{installed}} \leq 0.85 \text{ W}/(\text{m}^2 \text{ K})$
with $U_g = 0.70 \text{ W}/(\text{m}^2 \text{ K})$

Hygiene $f_{Rsi=0.25} \geq 0.70$

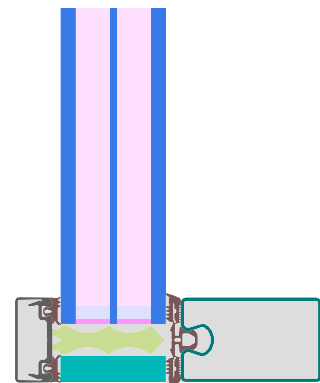

cool, temperate climate



**CERTIFIED
COMPONENT**

Passive House Institute

Passive House
efficiency class

phE

phD

phC

phB

phA

www.passivehouse.com

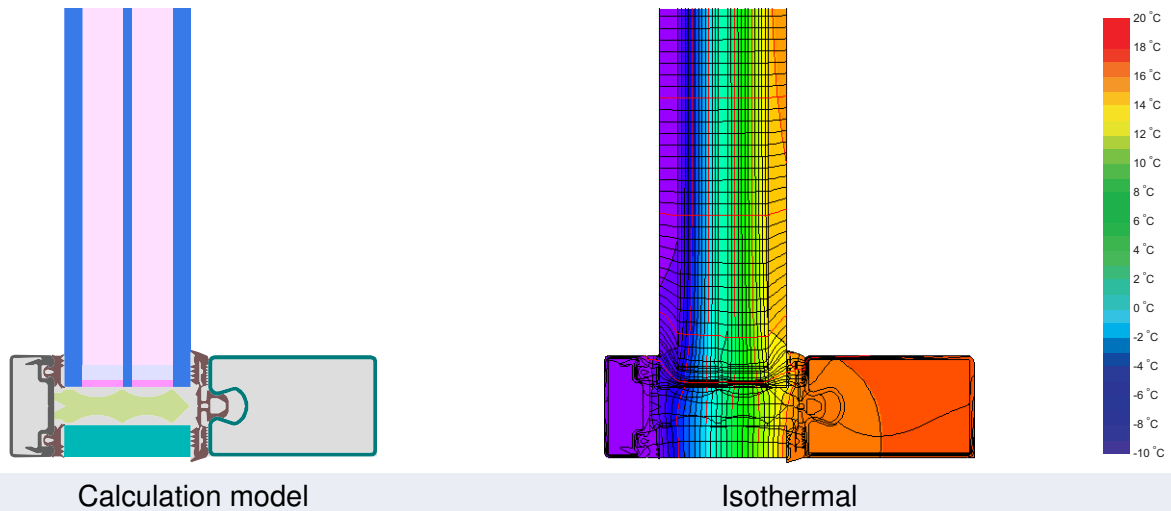

Description

Steel facade with exterior aluminum cladding and internal screwing duct. Glass carrier and screw losses determined by simulation (PHI). PE-foam rebate insulation (0,038 W/(mK)). Pane thickness: 56 mm (8/18/4/18/8), rebate depth: 14 mm, spacer: SWISSPACER Ultimate.

Explanation







The element U-values were calculated for the test element size of 1.20 m × 2.50 m with $U_g = 0.70 \text{ W}/(\text{m}^2 \text{ K})$. If a higher quality glazing is used, the element U-values will improve as follows:

Glazing	$U_g =$	0.70	0.64	0.58	0.52	W/(m ² K)
		↓	↓	↓	↓	
Element	U_{CW}	0.80	0.75	0.69	0.63	W/(m ² K)

Transparent building components are classified into efficiency classes depending on the heat losses through the opaque part. The frame U-Values, frame widths, thermal bridges at the glazing edge, and the glazing edge lengths are included in these heat losses. A more detailed report of the calculations performed in the context of certification is available from the manufacturer.

The Passive House Institute has defined international component criteria for seven climate zones. In principle, components which have been certified for climate zones with higher requirements may also be used in climates with less stringent requirements. In a particular climate zone it may make sense to use a component of a higher thermal quality which has been certified for a climate zone with more stringent requirements.

Further information relating to certification can be found on www.passivehouse.com and passipedia.org.

Frame values			Frame width b_f mm	U -value frame U_f^1 W/(m ² K)	Ψ -glass edge Ψ_g W/(m K)	Temp. Factor $f_{Rsi=0.25}$ [-]
Top fixed	(tof)		45	0.89	0.031	0.80
Side fixed	(sf)		45	0.89	0.031	0.80
Bottom fixed	(bof)		45	0.89	0.031	0.80
Mullion fixed	(m)		45	0.89	0.032	0.80
Transom fixed	(tf)		45	0.89	0.032	0.80
Transom 1 casement	(t1)		106	1.99	0.028	0.73
Spacer: SWISSPACER Ultimate			Secondary seal: Polysulfide			
Thermal glass carrier bridge ² $\chi_{GT} = 0.024$ W/K						

Validated installations

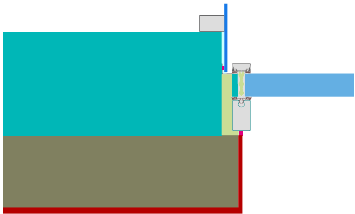
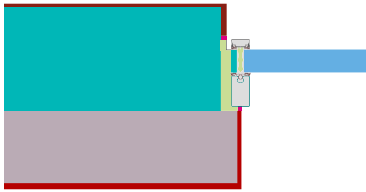
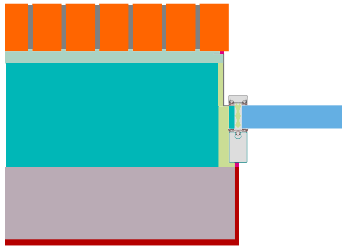
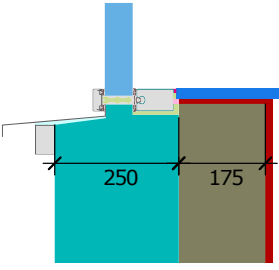
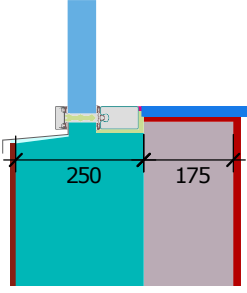
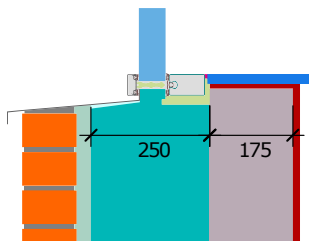
Ventilated facade (fixed glazing)	Exterior insulation and finishing system (EIFS) (fixed glazed)	Cavity wall (fixed glazing)
$U_{Wall} = 0.13$ W/(m ² K)	$U_{Wall} = 0.13$ W/(m ² K)	$U_{Wall} = 0.13$ W/(m ² K)
		
		
$\Psi_{install}$ W/(m K)	$\Psi_{install}$ W/(m K)	$\Psi_{install}$ W/(m K)
Top 0.017	Top 0.016	Top 0.016
Left 0.017	Left 0.016	Left 0.016
Right 0.017	Right 0.016	Right 0.016
Bottom 0.015	Bottom 0.015	Bottom 0.016
$U_{W,installed} = 0.83$ W/(m ² K)	$U_{W,installed} = 0.83$ W/(m ² K)	$U_{W,installed} = 0.83$ W/(m ² K)

¹ Includes $\Delta U = 0.30$ W/(m² K). Determined through 3D - FEM Simulation

² Determined through 3D - FEM Simulation . Glas support type : Stainless Steel

