

# CERTIFICATE

Certified Passive House Component

Component-ID 0991cw03 valid until 31st December 2017

Passive House Institute  
Dr. Wolfgang Feist  
64283 Darmstadt  
Germany

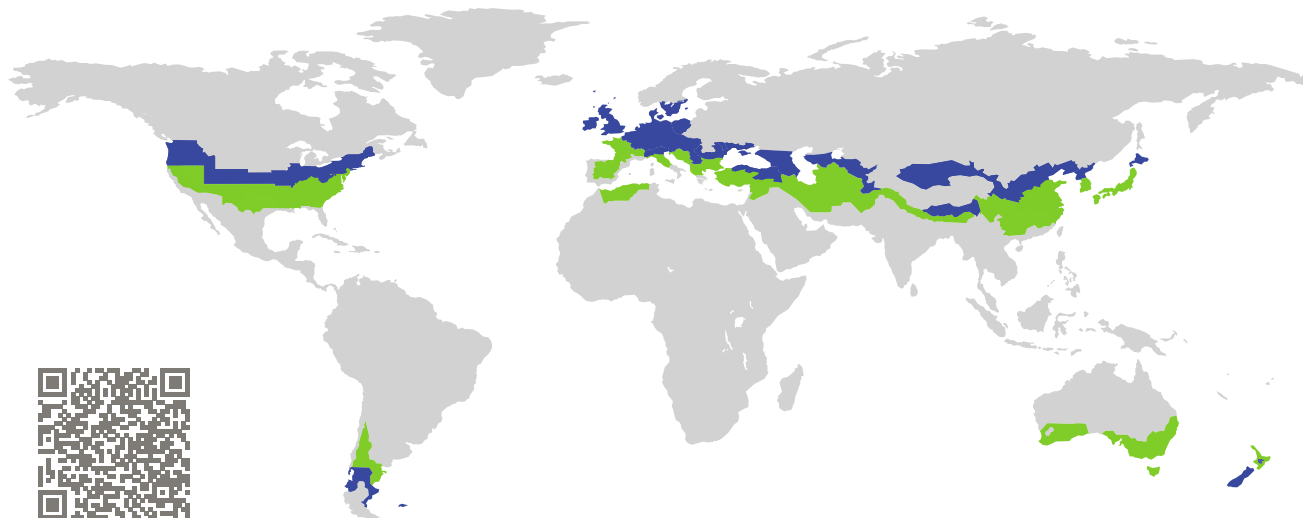

Category: **Curtain Wall**  
Manufacturer: **Forster Profilsysteme AG,  
Arbon,  
Switzerland**  
Product name: **forster thermfix® vario Hi 60 mm**

**This certificate was awarded based on the following  
criteria for the cool, temperate climate zone**

Comfort  $U_{CW} = 0.80 \leq 0.80 \text{ W}/(\text{m}^2 \text{ K})$   
 $U_{CW, \text{installed}} \leq 0.85 \text{ W}/(\text{m}^2 \text{ K})$   
with  $U_g = 0.70 \text{ W}/(\text{m}^2 \text{ K})$

Hygiene  $f_{Rsi=0.25} \geq 0.70$

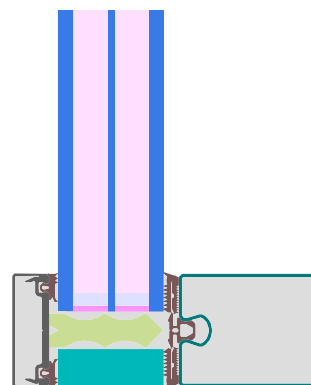

cool, temperate climate



**CERTIFIED  
COMPONENT**

Passive House Institute

Passive House  
efficiency class

phE

phD

phC

phB

phA

[www.passivehouse.com](http://www.passivehouse.com)

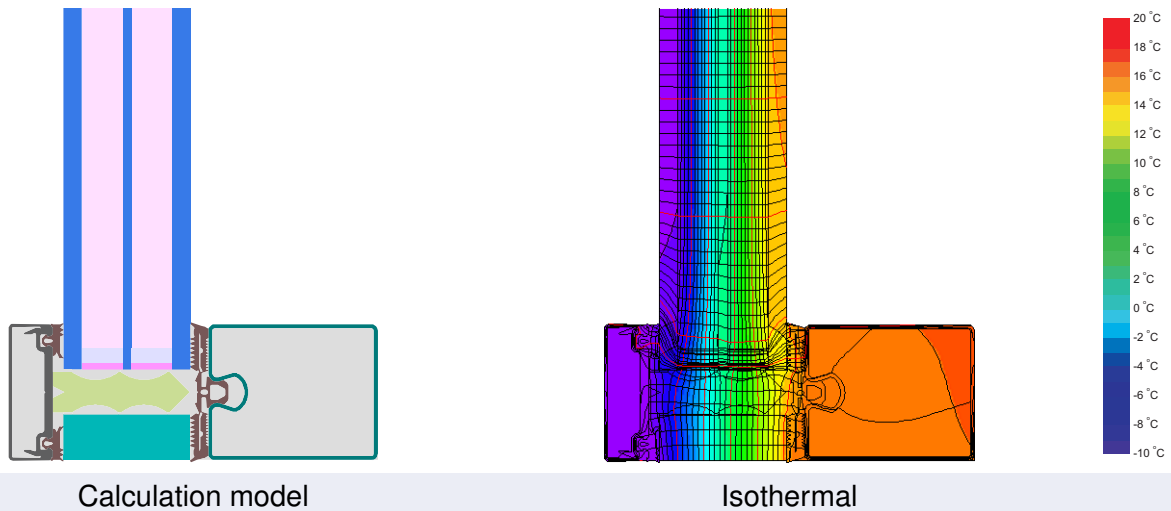

## Description

Steel facade with exterior aluminum cladding and internal screwing duct. Glass carrier and screw-losses determined by simulation (PHI). PE-foam rebate insulation (0,038 W/(mK)). Pane thickness: 56 mm (8/18/4/18/8), rebate depth: 14 mm, spacer: SWISSPACER Ultimate.

## Explanation







The element U-values were calculated for the test element size of 1.20 m × 2.50 m with  $U_g = 0.70 \text{ W}/(\text{m}^2 \text{ K})$ . If a higher quality glazing is used, the element U-values will improve as follows:

Glazing	$U_g =$	0.70	0.64	0.58	0.52	W/(m <sup>2</sup> K)
		↓	↓	↓	↓	
Element	$U_{CW}$	0.80	0.74	0.69	0.63	W/(m <sup>2</sup> K)

Transparent building components are classified into efficiency classes depending on the heat losses through the opaque part. The frame U-Values, frame widths, thermal bridges at the glazing edge, and the glazing edge lengths are included in these heat losses. A more detailed report of the calculations performed in the context of certification is available from the manufacturer.

The Passive House Institute has defined international component criteria for seven climate zones. In principle, components which have been certified for climate zones with higher requirements may also be used in climates with less stringent requirements. In a particular climate zone it may make sense to use a component of a higher thermal quality which has been certified for a climate zone with more stringent requirements.

Further information relating to certification can be found on [www.passivehouse.com](http://www.passivehouse.com) and [passipedia.org](http://passipedia.org).

Frame values			Frame width $b_f$ mm	$U$ -value frame $U_f^1$ W/(m <sup>2</sup> K)	$\Psi$ -glass edge $\Psi_g$ W/(m K)	Temp. Factor $f_{Rsi=0.25}$ [-]
Top fixed	(tof)		60	0.79	0.031	0.81
Side fixed	(sf)		60	0.79	0.031	0.81
Bottom fixed	(bof)		60	0.79	0.031	0.81
Mullion fixed	(m)		60	0.79	0.032	0.81
Transom fixed	(tf)		60	0.79	0.032	0.81
Transom 1 casement	(t1)		121	1.80	0.028	0.72
Spacer: SWISSPACER Ultimate			Secondary seal: Polysulfide			
Thermal glass carrier bridge <sup>2</sup> $\chi_{GT} = 0.024$ W/K						

### Validated installations

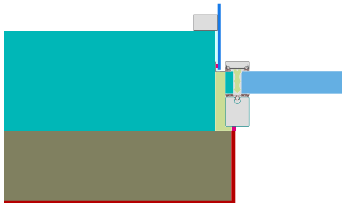
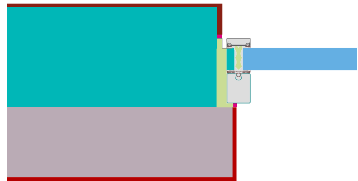
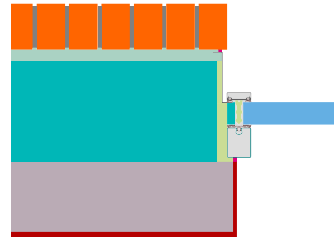
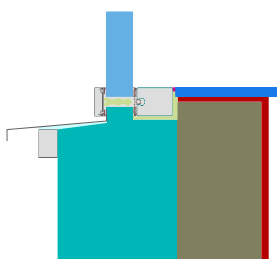
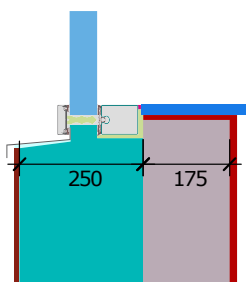
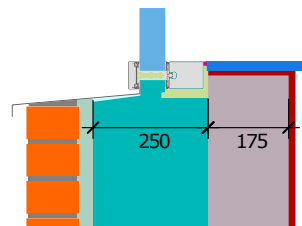
Ventilated facade (fixed glazing)	Exterior insulation and finishing system (EIFS) (fixed glazed)	Cavity wall (fixed glazing)
$U_{Wall} = 0.13$ W/(m <sup>2</sup> K)	$U_{Wall} = 0.13$ W/(m <sup>2</sup> K)	$U_{Wall} = 0.13$ W/(m <sup>2</sup> K)
		
		
$\Psi_{install}$ W/(m K)	$\Psi_{install}$ W/(m K)	$\Psi_{install}$ W/(m K)
Top 0.017	Top 0.015	Top 0.016
Left 0.017	Left 0.015	Left 0.016
Right 0.017	Right 0.015	Right 0.016
Bottom 0.015	Bottom 0.015	Bottom 0.015
$U_{W,installed} = 0.82$ W/(m <sup>2</sup> K)	$U_{W,installed} = 0.82$ W/(m <sup>2</sup> K)	$U_{W,installed} = 0.82$ W/(m <sup>2</sup> K)

<sup>1</sup> Includes  $\Delta U = 0.23$  W/(m<sup>2</sup> K). Determined through 3D - FEM Simulation

<sup>2</sup> Determined through 3D - FEM Simulation . Glas support type : Stainless Steel

