

CERTIFICATE

Certified Passive House Component

Component-ID 0808cw03 valid until 31st December 2017

Passive House Institute
Dr. Wolfgang Feist
64283 Darmstadt
Germany

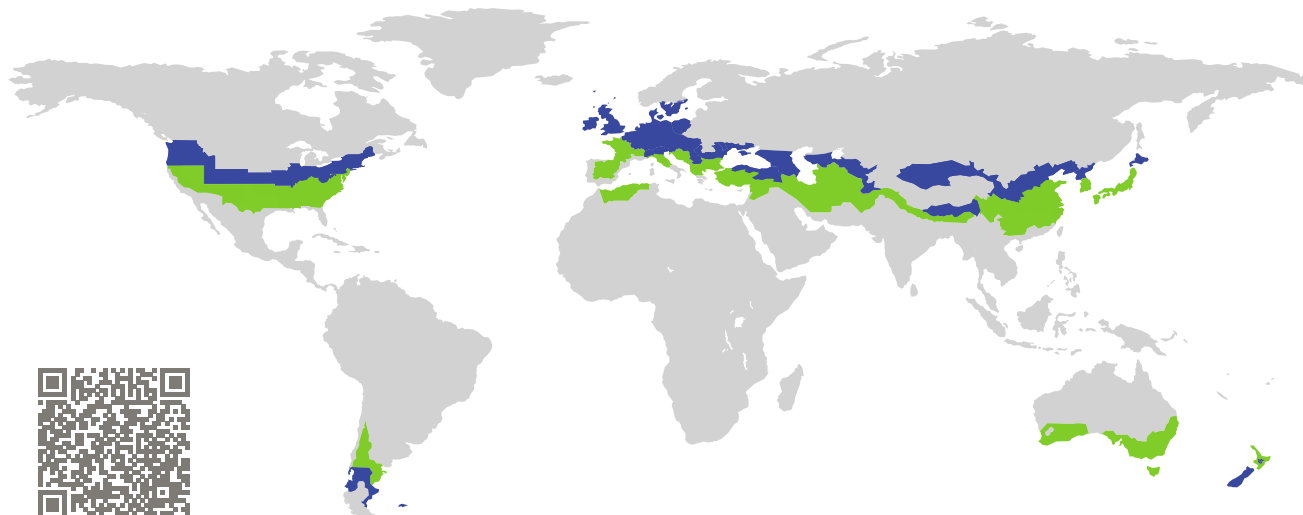

Category: **Curtain Wall**
Manufacturer: **Harbin Sayyas Windows Stock Co. Ltd.,
Wanggang Town Nangang Distr.
Harbin,
People's Republic of China**
Product name: **Scw60**

This certificate was awarded based on the following criteria for the cool, temperate climate zone

Comfort $U_{CW} = 0.79 \leq 0.80 \text{ W}/(\text{m}^2 \text{ K})$
 $U_{CW, \text{installed}} \leq 0.85 \text{ W}/(\text{m}^2 \text{ K})$
with $U_g = 0.70 \text{ W}/(\text{m}^2 \text{ K})$

Hygiene $f_{Rsi=0.25} \geq 0.70$

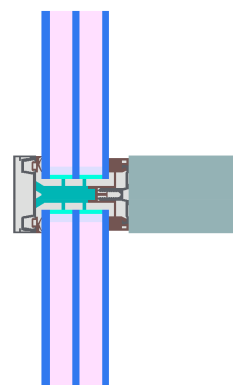

Passive House
efficiency class

phE

phD

phC

phB

phA

cool, temperate climate



**CERTIFIED
COMPONENT**

Passive House Institute

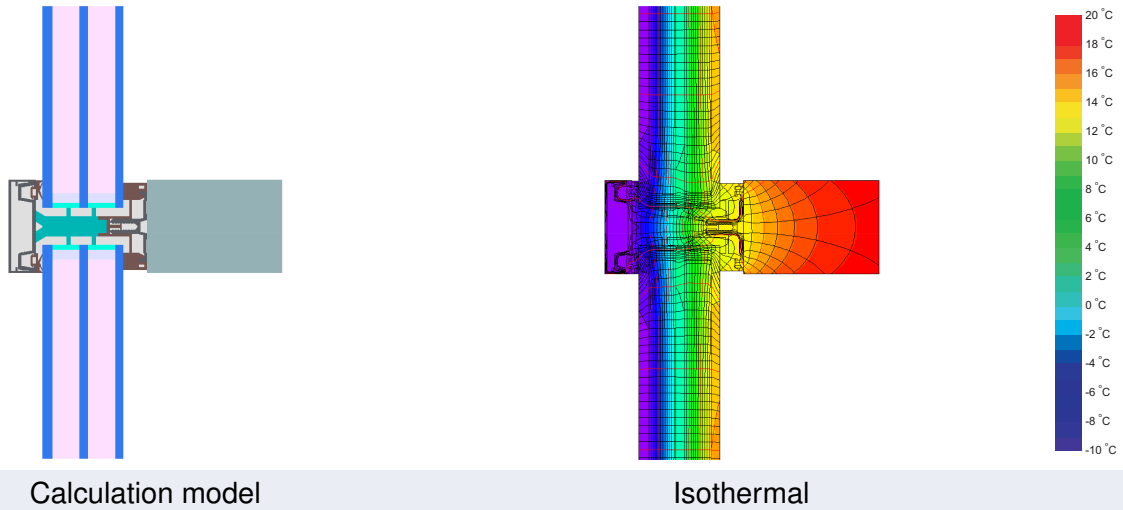

Description

Timber aluminium facade (Spruce/fir 0,11 W/(mK)), insulated by PE-foam (0,035 W/(mK)). Pane thickness: 48 mm (6/16/5/16/5), rebate depth: 18 mm. Losses by screws and glass carrier were determined by 3d-thermal flux analysis (PHI). Spacer: SWISSPACER Ultimate with butyl as secondary seal

Explanation







The element U-values were calculated for the test element size of 1.20 m × 2.50 m with $U_g = 0.70 \text{ W}/(\text{m}^2 \text{ K})$. If a higher quality glazing is used, the element U-values will improve as follows:

Glazing	$U_g =$	0.70	0.69	0.58	0.53	W/(m ² K)
		↓	↓	↓	↓	
Element	U_{CW}	0.79	0.78	0.68	0.63	W/(m ² K)

Transparent building components are classified into efficiency classes depending on the heat losses through the opaque part. The frame U-Values, frame widths, thermal bridges at the glazing edge, and the glazing edge lengths are included in these heat losses. A more detailed report of the calculations performed in the context of certification is available from the manufacturer.

The Passive House Institute has defined international component criteria for seven climate zones. In principle, components which have been certified for climate zones with higher requirements may also be used in climates with less stringent requirements. In a particular climate zone it may make sense to use a component of a higher thermal quality which has been certified for a climate zone with more stringent requirements.

Further information relating to certification can be found on www.passivehouse.com and passipedia.org.

Frame values			Frame width b_f mm	U -value frame U_f^1 W/(m ² K)	Ψ -glass edge Ψ_g W/(m K)	Temp. Factor $f_{Rsi=0.25}$ [-]
Top fixed	(tof)		60	0.99	0.025	0.77
Side fixed	(sf)		60	0.99	0.025	0.77
Bottom fixed	(bof)		60	0.99	0.025	0.77
Mullion fixed	(m)		60	0.99	0.025	0.77
Transom fixed	(tf)		60	0.99	0.025	0.77
Transom 1 casement	(t1)		170	0.88	0.018	0.77
Spacer: SWISSPACER Ultimate			Secondary seal: Butyl			
Thermal glass carrier bridge ² $\chi_{GT} = 0.015$ W/K						

Validated installations

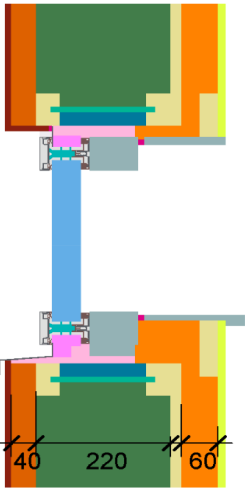
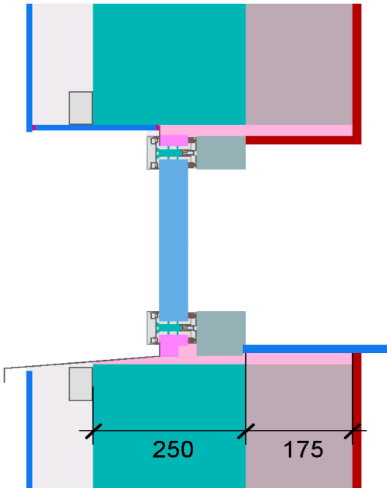
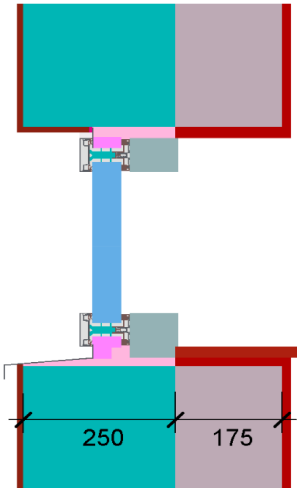
Lighthweight timber (fixed glazed)		Ventilated facade (fixed glazing)		Exterior insulation and finishing system (EIFS) (fixed glazed)	
					
$\Psi_{install}$	W/(m K)	$\Psi_{install}$	W/(m K)	$\Psi_{install}$	W/(m K)
Top	0.030	Top	0.022	Top	0.022
Left	0.030	Left	0.022	Left	0.022
Right	0.030	Right	0.022	Right	0.022
Bottom	0.033	Bottom	0.031	Bottom	0.031
$U_{W,installed} = 0.84$ W/(m ² K)		$U_{W,installed} = 0.83$ W/(m ² K)		$U_{W,installed} = 0.83$ W/(m ² K)	

¹ Includes $\Delta U = 0.26$ W/(m² K). Determined through 3D - FEM Simulation

² Determined through 3D - FEM Simulation . Glass support type : Non-Metallic Glass Carrier with Screws

