

CERTIFICATE

Certified Passive House Component

Component-ID 0589wi03 valid until 31st December 2018

Passive House Institute
Dr. Wolfgang Feist
64283 Darmstadt
Germany

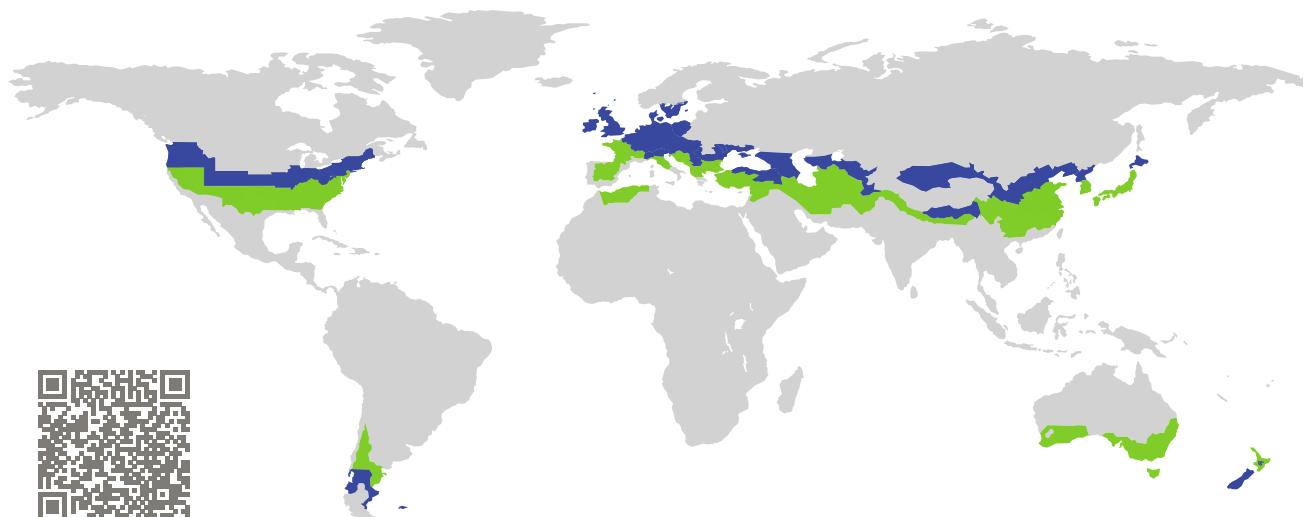

Category: **Window Frame**
Manufacturer: **OPTIWIN GmbH,
Ebbs,
Austria**
Product name: **FUTURA**

**This certificate was awarded based on the following
criteria for the cool, temperate climate zone**

Comfort $U_W = 0.79 \leq 0.80 \text{ W}/(\text{m}^2 \text{ K})$
 $U_{W,\text{installed}} \leq 0.85 \text{ W}/(\text{m}^2 \text{ K})$
with $U_g = 0.70 \text{ W}/(\text{m}^2 \text{ K})$

Hygiene $f_{Rsi=0.25} \geq 0.70$

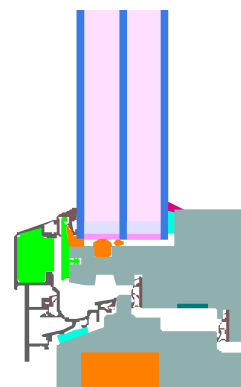

Passive House
efficiency class

phE

phD

phC

phB

phA

www.passivehouse.com

cool, temperate climate



phA



**CERTIFIED
COMPONENT**

Passive House Institute

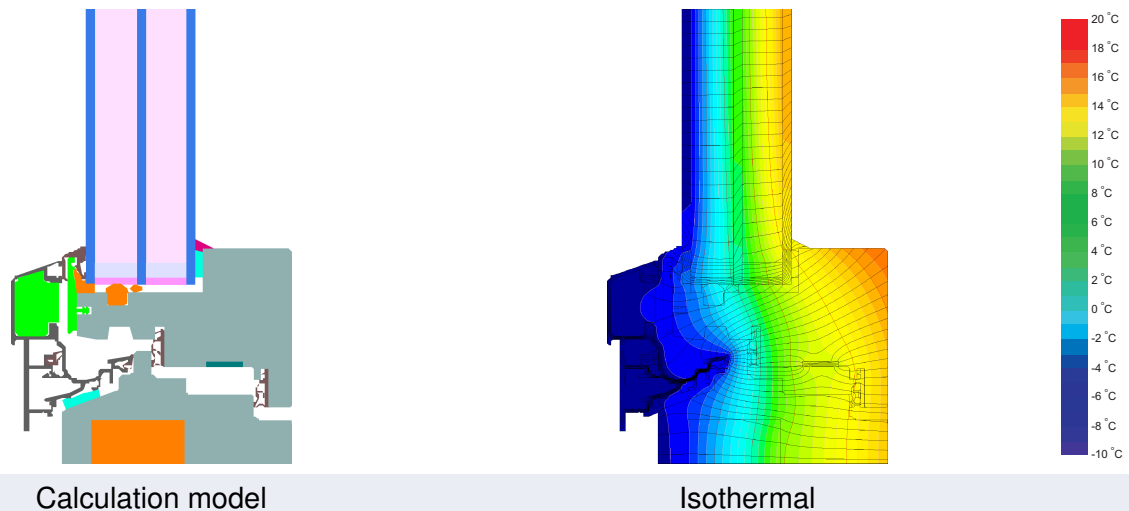

Calculation model

Isothermal

Description

Insulated (0,004 W/(mK)), aluminium cladmed timber (Fir, Spruce 0,11 W/(mK)) window frame. Pane thickness: 48 mm (4/18/4/18/4), Rebate depth: 16 mm.

Explanation





The window U-values were calculated for the test window size of 1.23 m × 1.48 m with $U_g = 0.70$ W/(m² K). If a higher quality glazing is used, the window U-values will improve as follows:

Glazing	$U_g =$	0.70	0.64	0.58	0.54	W/(m ² K)
		↓	↓	↓	↓	
Window	$U_W =$	0.79	0.74	0.70	0.67	W/(m ² K)

Transparent building components are classified into efficiency classes depending on the heat losses through the opaque part. The frame U-Values, frame widths, thermal bridges at the glazing edge, and the glazing edge lengths are included in these heat losses. A more detailed report of the calculations performed in the context of certification is available from the manufacturer.

The Passive House Institute has defined international component criteria for seven climate zones. In principle, components which have been certified for climate zones with higher requirements may also be used in climates with less stringent requirements. In a particular climate zone it may make sense to use a component of a higher thermal quality which has been certified for a climate zone with more stringent requirements.

Further information relating to certification can be found on www.passivehouse.com and passipedia.org.

Frame values			Frame width b_f mm	U -value frame U_f W/(m ² K)	Ψ -panel edge Ψ_g W/(m K)	Temp. Factor $f_{Rsi=0.25}$ [-]
Top	(to)		95	0.72	0.023	0.70
Side	(s)		95	0.72	0.023	0.70
Bottom	(bo)		95	1.08	0.023	0.70
Mullion flying	(fm)		112	0.88	0.023	0.70
			Spacer: SWISSPACER Ultimate		Secondary seal: Polysulfide	

Validated installations

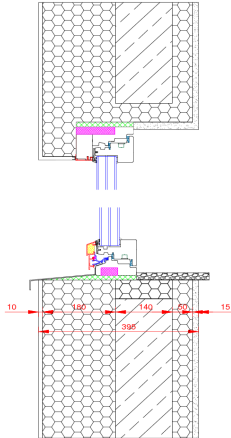
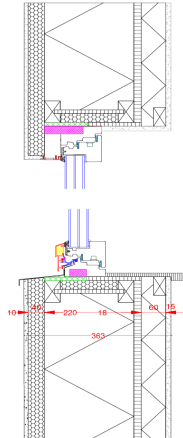
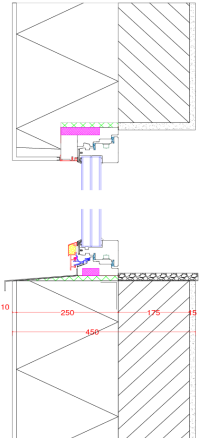
Insulated formwork blocks		Timber frame		EIFS	
					
$\Psi_{install}$	W/(m K)	$\Psi_{install}$	W/(m K)	$\Psi_{install}$	W/(m K)
Top	0.000	Top	0.014	Top	-0.001
Side	0.000	Side	0.014	Side	-0.001
Bottom	0.018	Bottom	0.023	Bottom	0.017
$U_{W,installed} = 0.80$ W/(m ² K)		$U_{W,installed} = 0.84$ W/(m ² K)		$U_{W,installed} = 0.80$ W/(m ² K)	

