

CERTIFICATE

Certified Passive House Component

Component-ID 0750wi03 valid until 31st December 2018

Passive House Institute
Dr. Wolfgang Feist
64283 Darmstadt
Germany

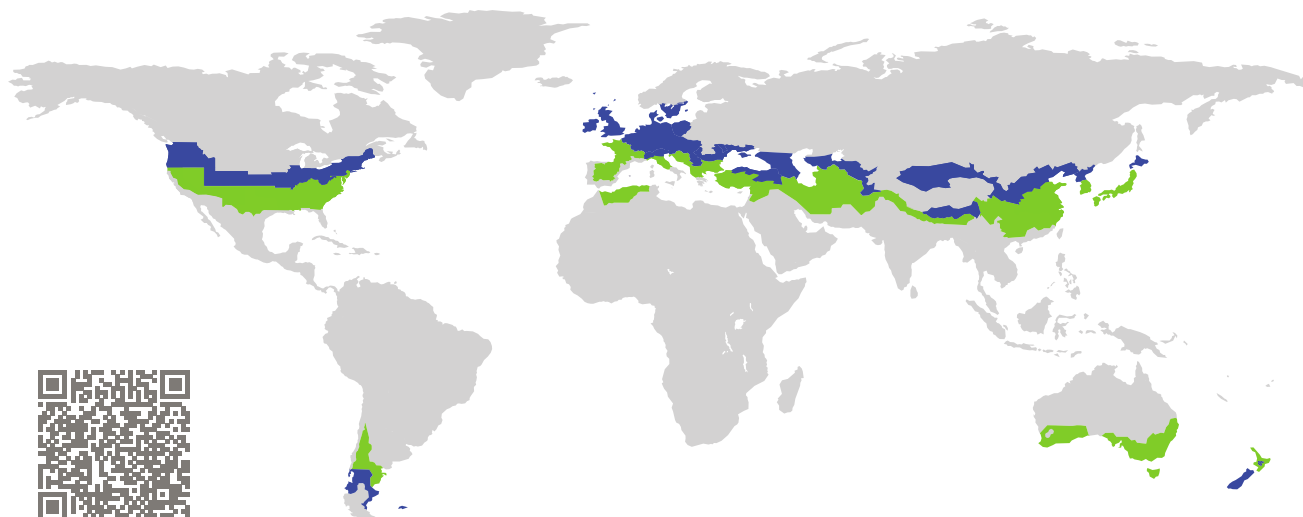

Category: **Window Frame**
Manufacturer: **POL-SKONE Sp. z o. o.,
LUBLIN,
Poland**
Product name: **EC90 PLUS ALU-EFFECT Typ A**

**This certificate was awarded based on the following
criteria for the cool, temperate climate zone**

Comfort $U_W = 0.77 \leq 0.80 \text{ W}/(\text{m}^2 \text{ K})$
 $U_{W,\text{installed}} \leq 0.85 \text{ W}/(\text{m}^2 \text{ K})$
with $U_g = 0.70 \text{ W}/(\text{m}^2 \text{ K})$

Hygiene $f_{Rsi=0.25} \geq 0.70$

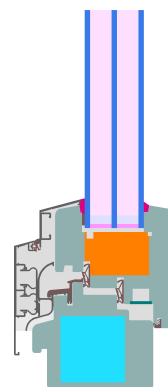

Passive House
efficiency class

phE

phD

phC

phB

phA

cool, temperate climate



**CERTIFIED
COMPONENT**

Passive House Institute

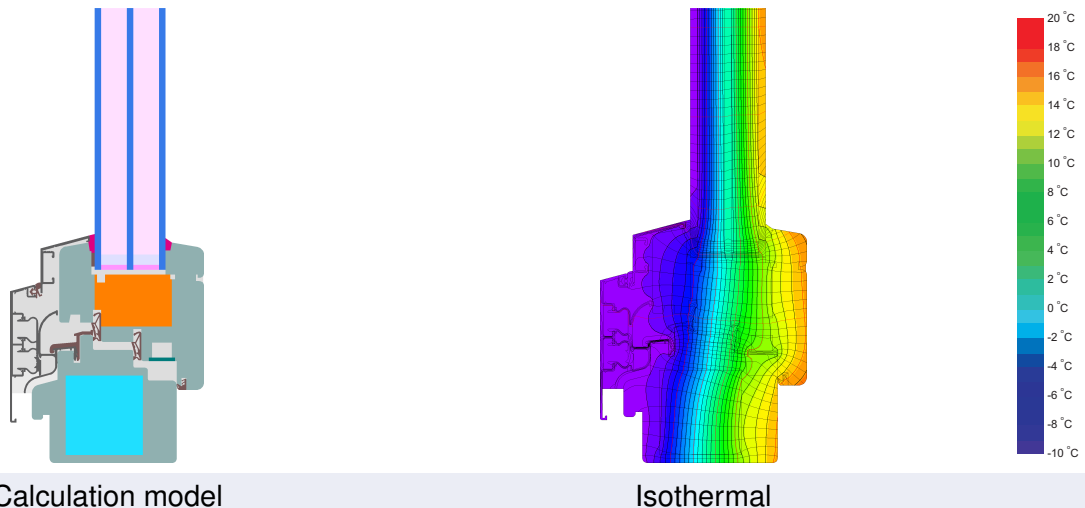

Description

Timberframe with aluminum facing shell with insulation cores of polyurethane (0.028 W/(mK)) and polystyrene-based-foam with high density (0.040 W/(mK)). Variants of the cladding available. Thermal properties of the frame unvaried. Pane thickness: 44 mm (4/16/4/16/4), Rebate depth: 20 mm.

Explanation





The window U-values were calculated for the test window size of 1.23 m × 1.48 m with $U_g = 0.70$ W/(m² K). If a higher quality glazing is used, the window U-values will improve as follows:

Glazing	$U_g =$	0.70	0.64	0.58	0.50	W/(m ² K)
		↓	↓	↓	↓	
Window	$U_W =$	0.77	0.73	0.69	0.64	W/(m ² K)

Transparent building components are classified into efficiency classes depending on the heat losses through the opaque part. The frame U-Values, frame widths, thermal bridges at the glazing edge, and the glazing edge lengths are included in these heat losses. A more detailed report of the calculations performed in the context of certification is available from the manufacturer.

The Passive House Institute has defined international component criteria for seven climate zones. In principle, components which have been certified for climate zones with higher requirements may also be used in climates with less stringent requirements. In a particular climate zone it may make sense to use a component of a higher thermal quality which has been certified for a climate zone with more stringent requirements.

Further information relating to certification can be found on www.passivehouse.com and passipedia.org.

Frame values			Frame width b_f mm	U -value frame U_f W/(m ² K)	Ψ -panel edge Ψ_g W/(m K)	Temp. Factor $f_{Rsi=0.25}$ [-]
Top	(to)		133	0.70	0.026	0.74
Side	(s)		133	0.70	0.026	0.74
Bottom	(bo)		141	0.77	0.026	0.74
Mullion flying	(fm)		148	0.74	0.026	0.74
			Spacer: SWISSPACER Ultimate		Secondary seal: Polysulfide	

Validated installations

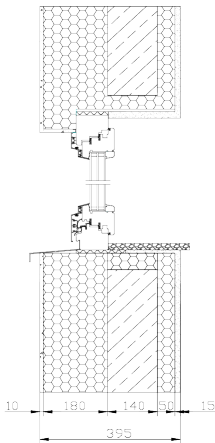
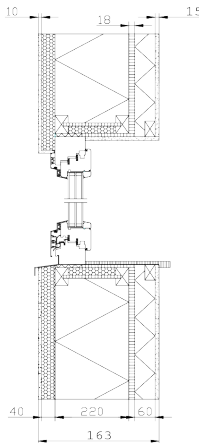
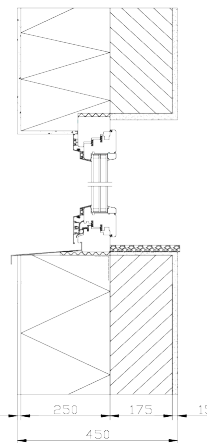
Insulated formwork blocks		Timber frame		EIFS	
					
$\Psi_{install}$	W/(m K)	$\Psi_{install}$	W/(m K)	$\Psi_{install}$	W/(m K)
Top	0.017	Top	0.024	Top	0.016
Side	0.017	Side	0.024	Side	0.016
Bottom	0.020	Bottom	0.030	Bottom	0.025
$U_{W,installed} = 0.82$ W/(m ² K)		$U_{W,installed} = 0.84$ W/(m ² K)		$U_{W,installed} = 0.82$ W/(m ² K)	

