

CERTIFICATE

Certified Passive House Component

Component-ID 1109ds02 valid until 31st December 2018

Passive House Institute
Dr. Wolfgang Feist
64283 Darmstadt
Germany

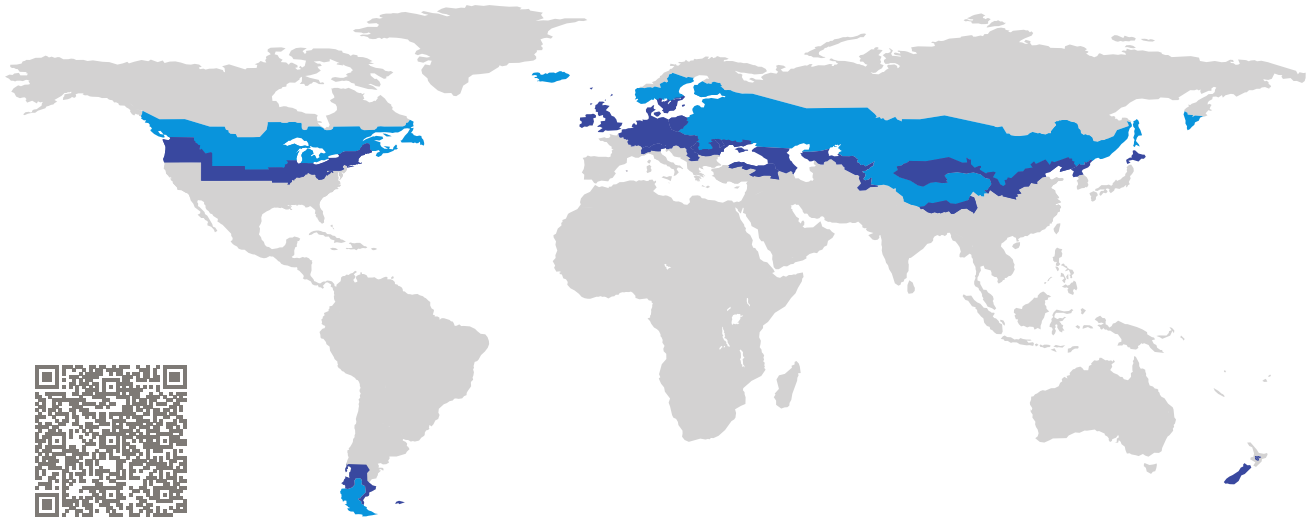

Category: **Door system**
Manufacturer: **pro Passivhausfenster GmbH**
Oberaudorf
Germany
Product name: **smartwin entrance**

This certificate was awarded based on the following criteria for the cold climate zone

Comfort $U_D = 0.66 \leq 0.60 \text{ W}/(\text{m}^2 \text{ K})$
 $U_{D,\text{installed}} \leq 0.65 \text{ W}/(\text{m}^2 \text{ K})$
with $U_{\text{door leaf}}^1 = 0.33 \text{ W}/(\text{m}^2 \text{ K})$

Hygiene $f_{Rsi=0.25} \geq 0.75$
Airtightness $Q_{100} = 0.6 \leq 2.25 \text{ m}^3/(\text{h m})$



(Inward opening)

¹U-value of the insulated area of door leaf



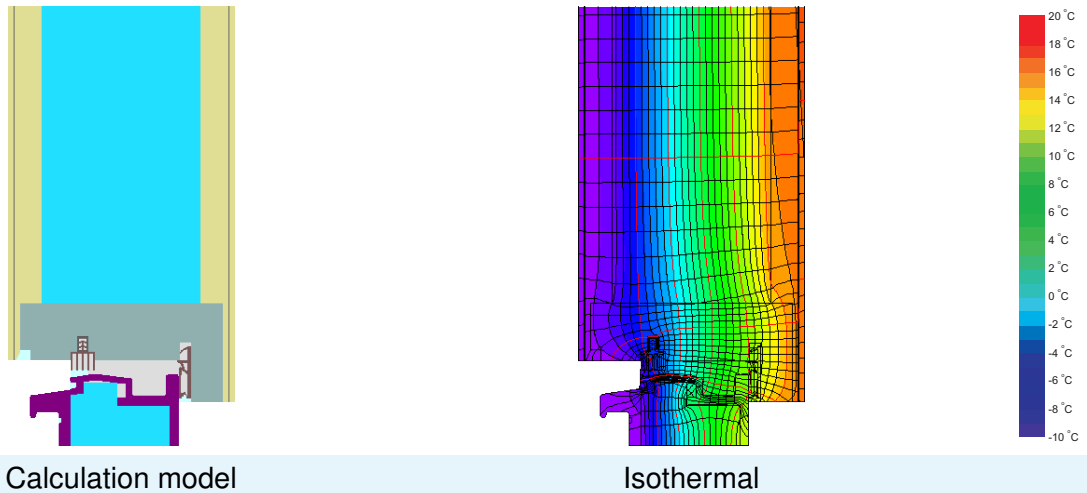

Description

Spruce/Fir-Aluminum frame, insulated by wood fibre board (0.040 W/(mK)). Door leaf from timber-Aluminum composit, insulated by PU-foam (0.027 W/(mK)) Glazing of fixed part: 4/18/4/18/4, $U_g=0.52$ W/(m²K). At the threshold (determined with installation) and the narrow mullion, the temperature facort for the cold climate is not achieved. Never the less, this values are much better than usual. Byond the requirements, airtightness class 4 according to EN 12207 is achieved.

Explanation

The U-values of the door apply to a combination of door and sidelight with fixed glazing, 2.20 m wide by 2.20 m tall. The door and the sidelight are both 1.10 m wide.

A detailed report of the calculations performed in the context of certification is available from the manufacturer.

Unless stated otherwise, the air tightness was determined according to EN 1026 with respect to the joint length under climate load in conjunction with EN 1121 for the closed, non-locked door. The result corresponds at least to air-tightness class 3 according to EN 12207.

The Passive House Institute has defined international component criteria for seven climate zones. In principle, components which have been certified for climate zones with higher requirements may also be used in climates with less stringent requirements. In a particular climate zone it may make sense to use a component of a higher thermal quality which has been certified for a climate zone with more stringent requirements.

Further information relating to certification can be found on www.passivehouse.com and passipedia.org.

Frame values			Frame width b_f mm	U -value frame U_f W/(m ² K)	Ψ edge Ψ_g W/(m K)	Temp. Factor $f_{Rsi=0.25}$ [-]
Top	(to)		86	0.64	0.005	0.87
Top fixed	(tof)		86	0.52	0.021	0.78
Side fixed	(sf)		86	0.52	0.021	0.78
Bottom fixed	(bof)		86	0.69	0.021	0.76
Threshold	(th)		65	1.28	0.001	0.68
Hinge side Door	(hs)		86	0.64	0.005	0.87
Lock side Door	(ls)		176	0.59	0.000	0.86
Mullion flying	(fm)		152	0.70	0.014	0.89
Mullion 1 casement	(m1)		110	0.78	0.014	0.74
Mullion 1 casement Variant 1	(m1)		172	0.60	0.013	0.77
Spacer: SWISSPACER Ultimate			Secondary seal: Polyurethane			

Top

$b_f = 86.00$ mm

$U_f = 0.64$ W/(m² K)

$\Psi_g = 0.005$ W/(m K)

$f_{Rsi} = 0.87$

Top fixed

$b_f = 86.00$ mm

$U_f = 0.52$ W/(m² K)

$\Psi_g = 0.021$ W/(m K)

$f_{Rsi} = 0.78$



Side

fixed

$$b_f = 86.00 \text{ mm}$$

$$U_f = 0.52 \text{ W}/(\text{m}^2 \text{ K})$$

$$\Psi_g = 0.021 \text{ W}/(\text{m K})$$

$$f_{Rsi} = 0.78$$

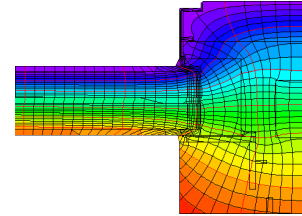
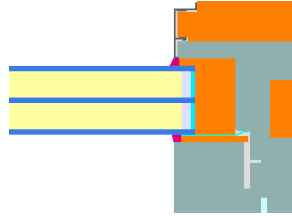

Bottom

fixed

$$b_f = 86.00 \text{ mm}$$

$$U_f = 0.69 \text{ W}/(\text{m}^2 \text{ K})$$

$$\Psi_g = 0.021 \text{ W}/(\text{m K})$$

$$f_{Rsi} = 0.76$$

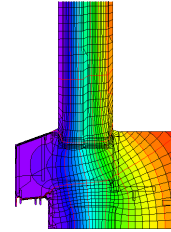
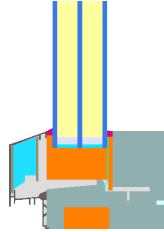

Threshold

$$b_f = 65.00 \text{ mm}$$

$$U_f = 1.28 \text{ W}/(\text{m}^2 \text{ K})$$

$$\Psi_g = 0.001 \text{ W}/(\text{m K})$$

$$f_{Rsi} = 0.68$$

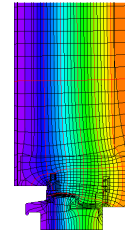
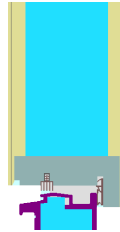

Hinge side

Door

$$b_f = 86.00 \text{ mm}$$

$$U_f = 0.64 \text{ W}/(\text{m}^2 \text{ K})$$

$$\Psi_g = 0.005 \text{ W}/(\text{m K})$$

$$f_{Rsi} = 0.87$$

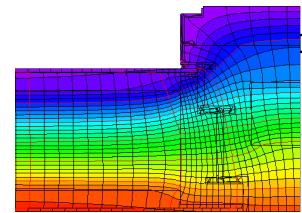
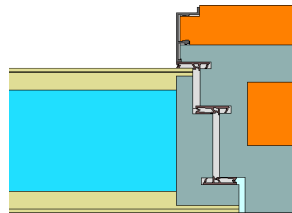

Lock side

Door

$$b_f = 176.00 \text{ mm}$$

$$U_f = 0.59 \text{ W}/(\text{m}^2 \text{ K})$$

$$\Psi_g = 0.000 \text{ W}/(\text{m K})$$

$$f_{Rsi} = 0.86$$

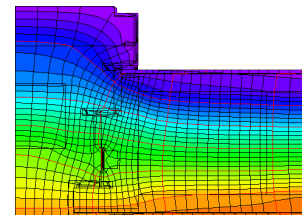
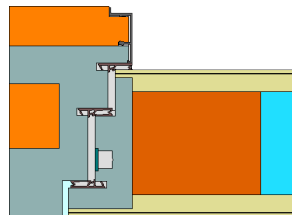



Mullion

flying

$$b_f = 152.00 \text{ mm}$$

$$U_f = 0.70 \text{ W}/(\text{m}^2 \text{ K})$$

$$\Psi_g = 0.014 \text{ W}/(\text{m K})$$

$$f_{Rsi} = 0.89$$

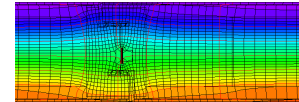
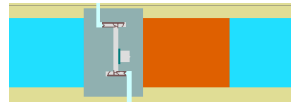

Mullion

1 casement

$$b_f = 110.00 \text{ mm}$$

$$U_f = 0.78 \text{ W}/(\text{m}^2 \text{ K})$$

$$\Psi_g = 0.014 \text{ W}/(\text{m K})$$

$$f_{Rsi} = 0.74$$

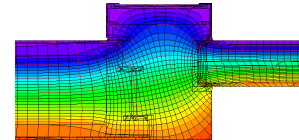
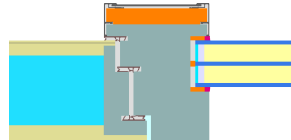

Mullion

1 casement Variant 1

$$b_f = 172.00 \text{ mm}$$

$$U_f = 0.60 \text{ W}/(\text{m}^2 \text{ K})$$

$$\Psi_g = 0.013 \text{ W}/(\text{m K})$$

$$f_{Rsi} = 0.77$$

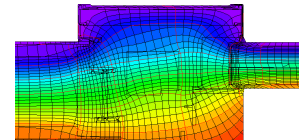
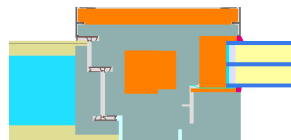

Door with glas section/infill

Glazing/Infill : 1

$$U_p = 0.52 \text{ W}/(\text{m}^2 \text{ K})$$

$$\Psi = 0.030 \text{ W}/(\text{m K})$$

$$f_{Rsi} = 0.79$$

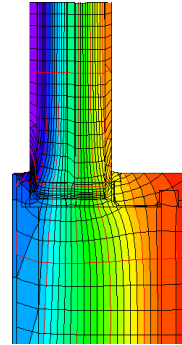
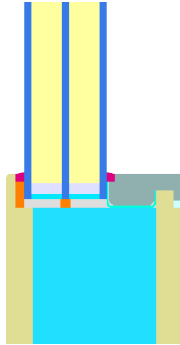

Description:

Glazing: 4/18/4/18/4

The comfort criterion limits the use of the infill element as follows:

Maximum area = 1.56 m²

Maximum circumference = 5.56 m

Validated installations

Exterior insul. and finish s. (EIFS)
threshold (fixed glazing)

$$U_1 = 0.11 \quad U_2 = 0.12 \quad [\text{W}/(\text{m}^2 \text{K})]$$

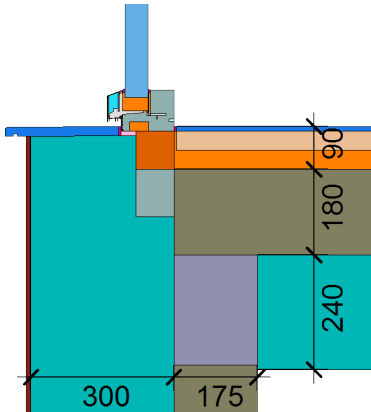

$$\Psi_{\text{install}} = 0.021 \text{ W}/(\text{m K})$$

Exterior insulation and finishing s (EIFS)
side (fixed glazed)

$$U_1 = 0.11 \quad [\text{W}/(\text{m}^2 \text{K})]$$

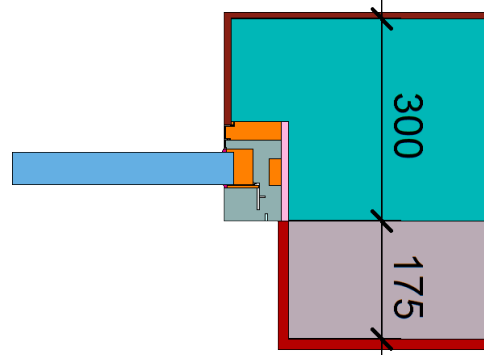

$$\Psi_{\text{install}} = 0.000 \text{ W}/(\text{m K})$$

Exterior insulation and finishing s (EIFS)
side (operable)

$$U_1 = 0.11 \quad [\text{W}/(\text{m}^2 \text{K})]$$

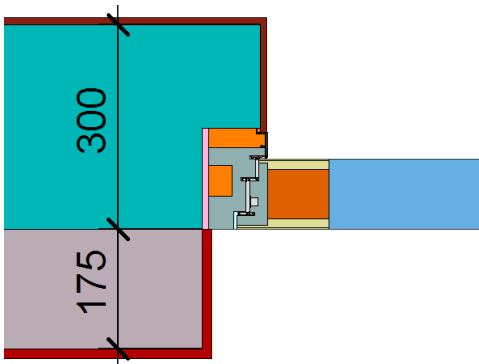

$$\Psi_{\text{install}} = 0.004 \text{ W}/(\text{m K})$$

Exterior insulation and finishing s (EIFS)
threshold (operable)

$$U_1 = 0.11 \quad U_2 = 0.12 \quad [\text{W}/(\text{m}^2 \text{K})]$$

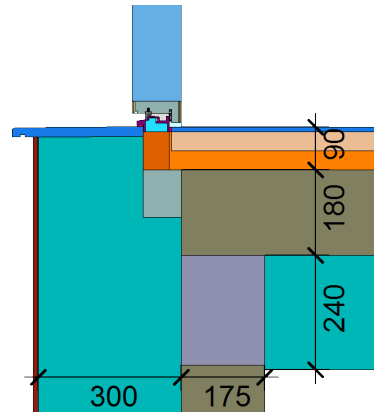

$$\Psi_{\text{install}} = 0.038 \text{ W}/(\text{m K})$$

Exterior insulation and finishing s (EIFS)
top (fixed glazing)

$$U_1 = 0.11 \quad [\text{W}/(\text{m}^2 \text{K})]$$

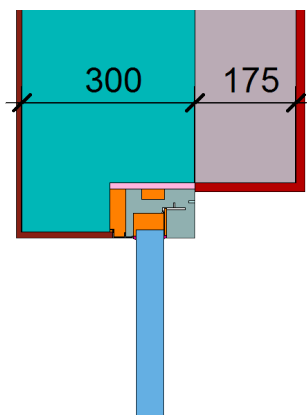

$$\Psi_{\text{install}} = 0.000 \text{ W}/(\text{m K})$$

Exterior insulation and finishing s (EIFS)
top (operable)

$$U_1 = 0.11 \quad [\text{W}/(\text{m}^2 \text{K})]$$

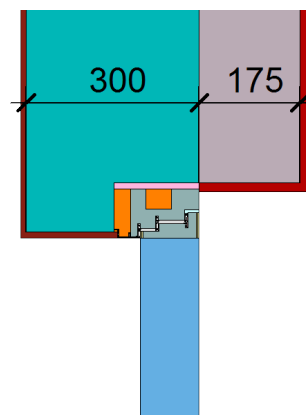

$$\Psi_{\text{install}} = 0.003 \text{ W}/(\text{m K})$$

Ext. ins. a. finish. s. (EIFS) threshold floor slab (fixed gl.)

$$U_1 = 0.13 \quad U_2 = 0.14 \quad [\text{W}/(\text{m}^2 \text{K})]$$

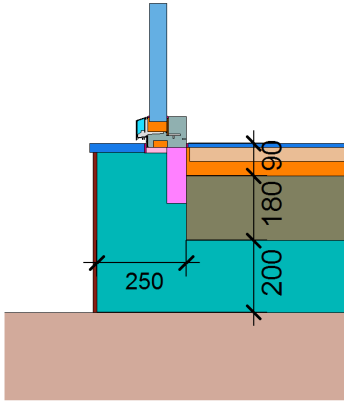

$$\Psi_{\text{install}} = 0.034 \text{ W}/(\text{mK})$$

Ext. ins. a. finish. s. (EIFS) threshold floor slab (operable)

$$U_1 = 0.13 \quad U_2 = 0.14 \quad [\text{W}/(\text{m}^2 \text{K})]$$

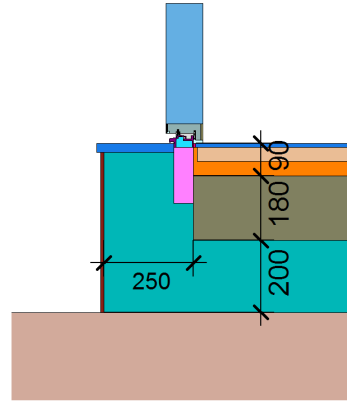

$$\Psi_{\text{install}} = 0.037 \text{ W}/(\text{mK})$$

Ext insulation a. finish. s. (EIFS) threshold ceiling (fixed gl.)

$$U_1 = 0.14 \quad [\text{W}/(\text{m}^2 \text{K})]$$

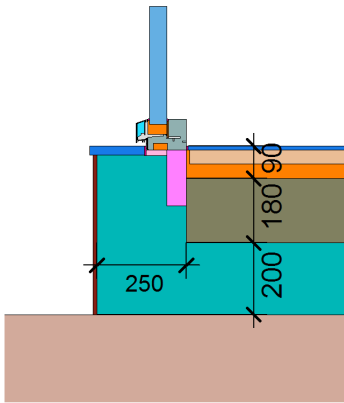

$$\Psi_{\text{install}} = 0.018 \text{ W}/(\text{mK})$$

Ext insulation a. finish. s. (EIFS) threshold ceiling (operable)

$$U_1 = 0.14 \quad [\text{W}/(\text{m}^2 \text{K})]$$

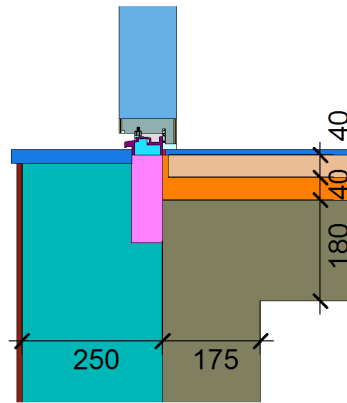

$$\Psi_{\text{install}} = 0.060 \text{ W}/(\text{mK})$$

Formwork blocks side (fixed)

$$U_1 = 0.10 \quad [\text{W}/(\text{m}^2 \text{K})]$$

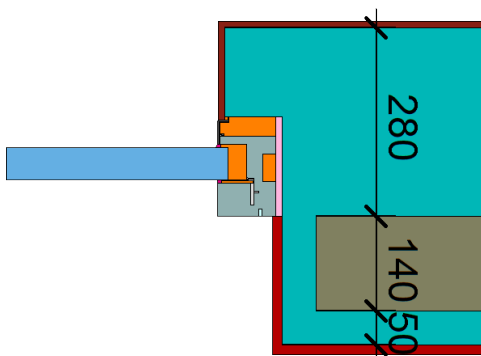

$$\Psi_{\text{install}} = 0.001 \text{ W}/(\text{mK})$$

Formwork blocks side (operable)

$$U_1 = 0.10 \quad [\text{W}/(\text{m}^2 \text{K})]$$

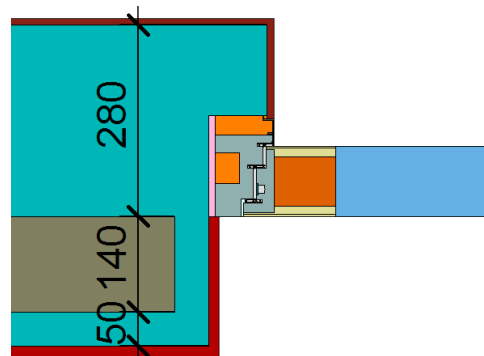

$$\Psi_{\text{install}} = 0.003 \text{ W}/(\text{mK})$$

Formwork blocks top (fixed)

$U_1 = 0.10 \text{ [W/(m}^2 \text{ K)]}$

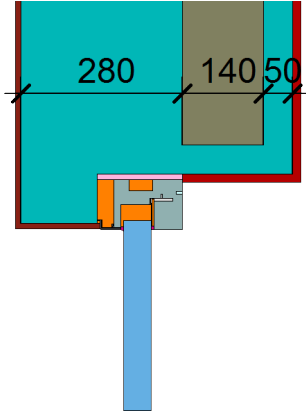

$\Psi_{\text{install}} = 0.001 \text{ W/(m K)}$

Formwork blocks top (operable)

$U_1 = 0.10 \text{ [W/(m}^2 \text{ K)]}$

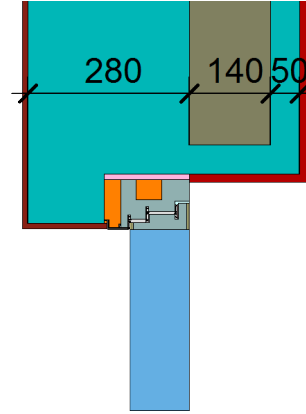

$\Psi_{\text{install}} = 0.003 \text{ W/(m K)}$

Lightweight timber side (fixed glazed)

$U_1 = 0.11 \text{ [W/(m}^2 \text{ K)]}$

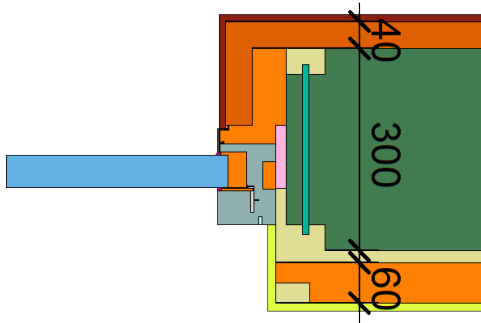

$\Psi_{\text{install}} = 0.009 \text{ W/(m K)}$

Lightweight timber side (operable)

$U_1 = 0.11 \text{ [W/(m}^2 \text{ K)]}$

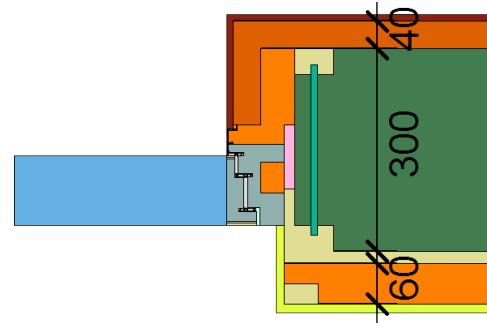

$\Psi_{\text{install}} = 0.008 \text{ W/(m K)}$

Lightweight timber top (fixed glazed)

$U_1 = 0.11 \text{ [W/(m}^2 \text{ K)]}$

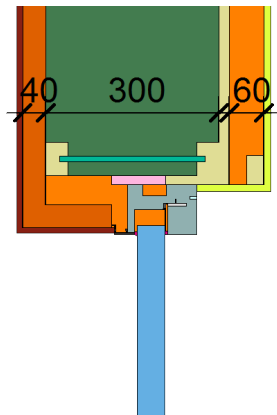

$\Psi_{\text{install}} = 0.009 \text{ W/(m K)}$

Lightweight timber top (operable)

$U_1 = 0.11 \text{ [W/(m}^2 \text{ K)]}$

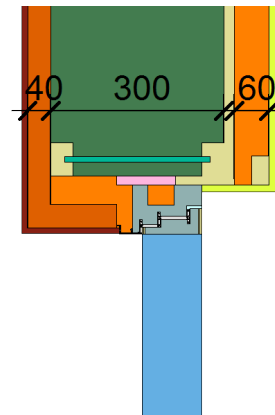

$\Psi_{\text{install}} = 0.007 \text{ W/(m K)}$

