

# CERTIFICATE

Certified Passive House Component

Component-ID 0636wi03 valid until 31st December 2017

Passive House Institute  
Dr. Wolfgang Feist  
64283 Darmstadt  
Germany

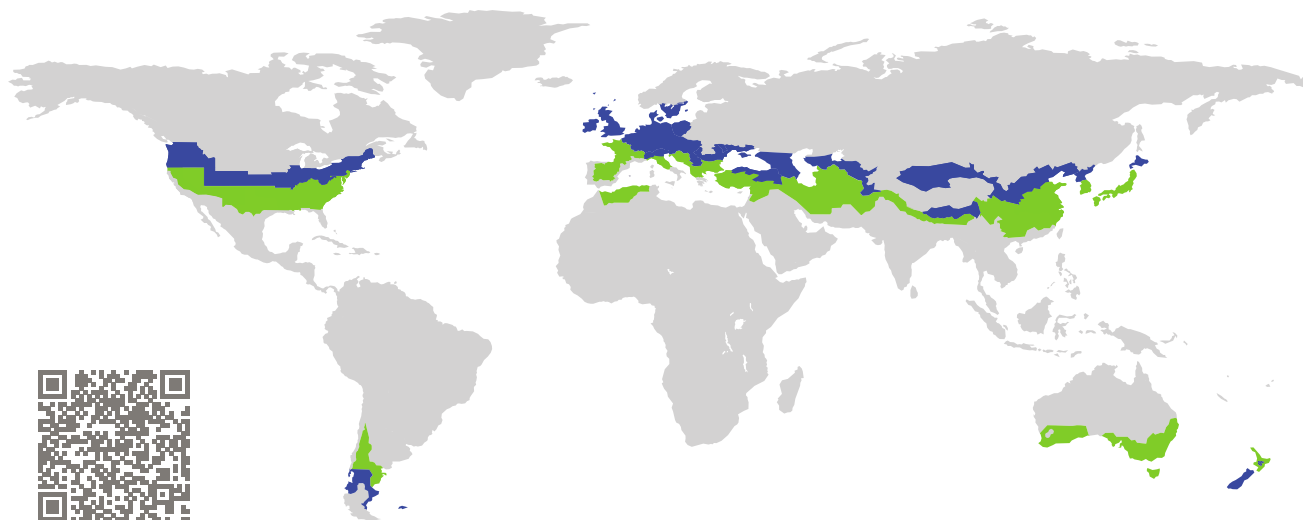

Category: **Window frame**  
Manufacturer: **PURAL GmbH & Co.KG,**  
**Riedstadt-Erfelden,**  
**Germany**  
Product name: **eco90**

**This certificate was awarded based on the following criteria for the cool, temperate climate zone**

Comfort  $U_W = 0.77 \leq 0.80 \text{ W}/(\text{m}^2 \text{ K})$   
 $U_{W,\text{installed}} \leq 0.85 \text{ W}/(\text{m}^2 \text{ K})$   
with  $U_g = 0.70 \text{ W}/(\text{m}^2 \text{ K})$

Hygiene  $f_{Rsi=0.25} \geq 0.70$

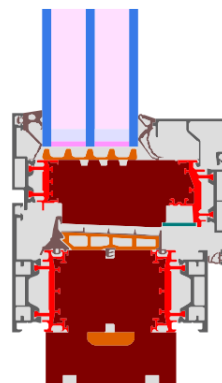

Passive House  
efficiency class

phE

phD

phC

phB

phA

[www.passivehouse.com](http://www.passivehouse.com)

cool, temperate climate



**CERTIFIED  
COMPONENT**

Passive House Institute

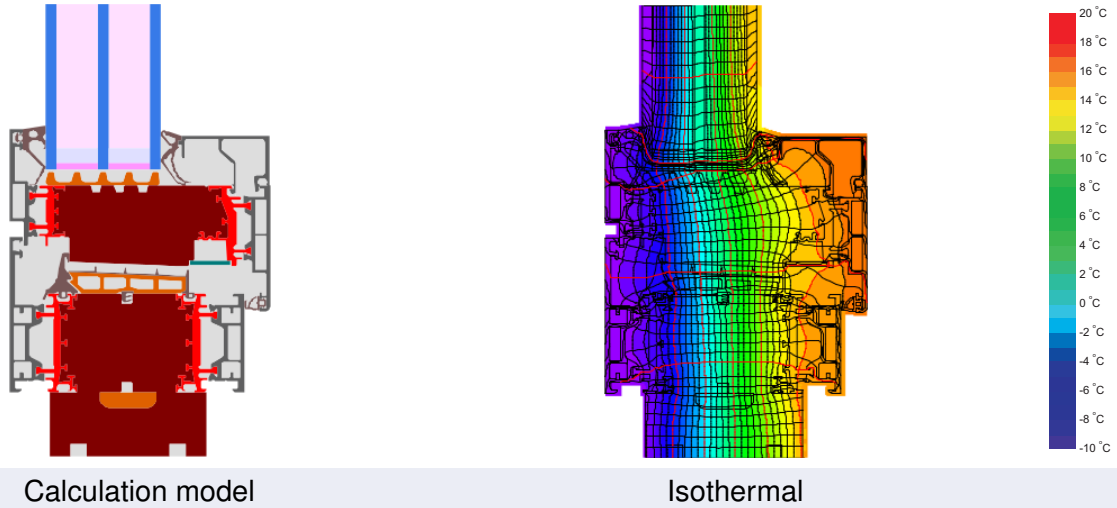

### Description

Thermally broken aluminum frame with PU-foam core (0,051 W/(mK)).. Pane thickness: 44 mm (4/16/4/16/4), Rebate depth: 15/18 mm.

### Explanation





The window U-values were calculated for the test window size of 1.23 m × 1.48 m with  $U_g = 0.70$  W/(m<sup>2</sup> K). If a higher quality glazing is used, the window U-values will improve as follows:

Glazing	$U_g =$	0.70	0.64	0.58	0.52	W/(m <sup>2</sup> K)
		↓	↓	↓	↓	
Window	$U_W =$	0.77	0.74	0.70	0.66	W/(m <sup>2</sup> K)

Transparent building components are classified into efficiency classes depending on the heat losses through the opaque part. The frame U-Values, frame widths, thermal bridges at the glazing edge, and the glazing edge lengths are included in these heat losses. A more detailed report of the calculations performed in the context of certification is available from the manufacturer.

The Passive House Institute has defined international component criteria for seven climate zones. In principle, components which have been certified for climate zones with higher requirements may also be used in climates with less stringent requirements. In a particular climate zone it may make sense to use a component of a higher thermal quality which has been certified for a climate zone with more stringent requirements.

Further information relating to certification can be found on [www.passivehouse.com](http://www.passivehouse.com) and [passipedia.org](http://passipedia.org).

Frame values			Frame width $b_f$ mm	$U$ -value frame $U_f$ W/(m <sup>2</sup> K)	$\Psi$ -glass edge $\Psi_g$ W/(m K)	Temp. Factor $f_{Rsi=0.25}$ [-]
Top	(to)		142	0.70	0.028	0.76
Side	(s)		142	0.70	0.028	0.76
Bottom	(bo)		147	0.79	0.028	0.76
Mullion flying	(fm)		134	0.78	0.029	0.75
			Spacer: SWISSPACER Ultimate		Secondary seal: Polyurethane	

### Validated installations

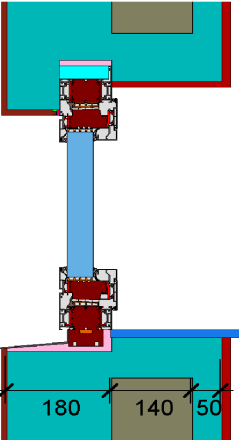
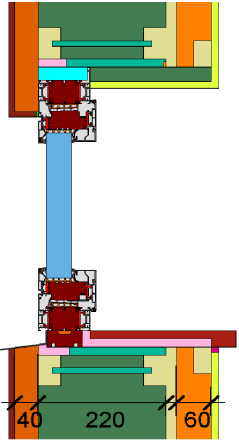
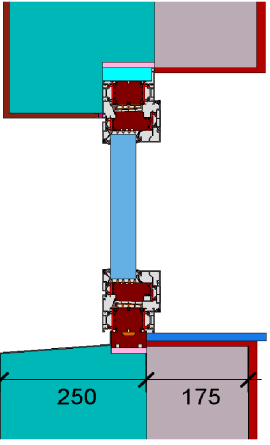
Insulated formwork blocks		Timber frame		EIFS	
					
$\Psi_{install}$	W/(m K)	$\Psi_{install}$	W/(m K)	$\Psi_{install}$	W/(m K)
Top	0.002	Top	0.023	Top	0.007
Side	0.002	Side	0.023	Side	0.007
Bottom	0.008	Bottom	0.025	Bottom	0.023
$U_{W,installed} = 0.78$ W/(m <sup>2</sup> K)		$U_{W,installed} = 0.84$ W/(m <sup>2</sup> K)		$U_{W,installed} = 0.81$ W/(m <sup>2</sup> K)	

