

# CERTIFICATE

Certified Passive House Component

Component-ID 0219ic03 valid until 31st December 2017

Passive House Institute  
Dr. Wolfgang Feist  
64283 Darmstadt  
Germany

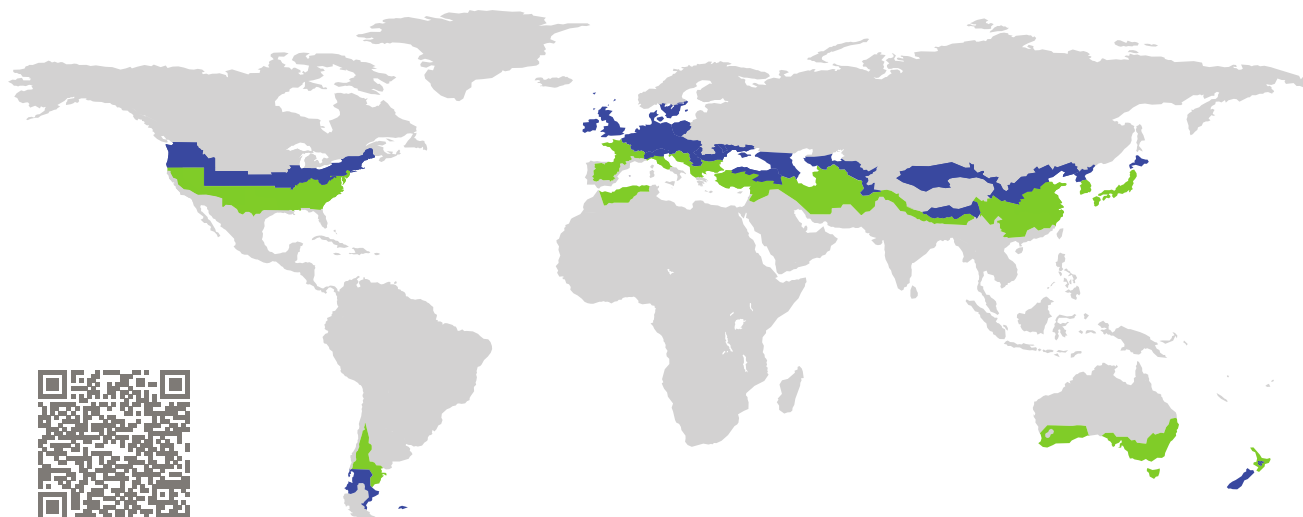

Category: **Glas roof**  
Manufacturer: **SCHÜCO International KG,  
Bielefeld,  
Germany**  
Product name: **Schüco AOC 50 ST.SI (schräg)**

**This certificate was awarded based on the following  
criteria for the cool, temperate climate zone**

Comfort  $U_{CW,i} = 0.81 \leq 1.00 \text{ W}/(\text{m}^2 \text{ K})$   
 $U_{CW,i,\text{installed}} \leq 1.00 \text{ W}/(\text{m}^2 \text{ K})$   
with  $U_g = 0.72 \text{ W}/(\text{m}^2 \text{ K})$

Hygiene  $f_{Rsi=0.25} \geq 0.70$

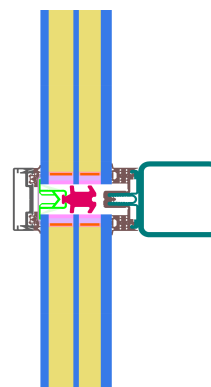

Passive House  
efficiency class

phE

phD

phC

phB

phA

cool, temperate climate



**CERTIFIED  
COMPONENT**

Passive House Institute

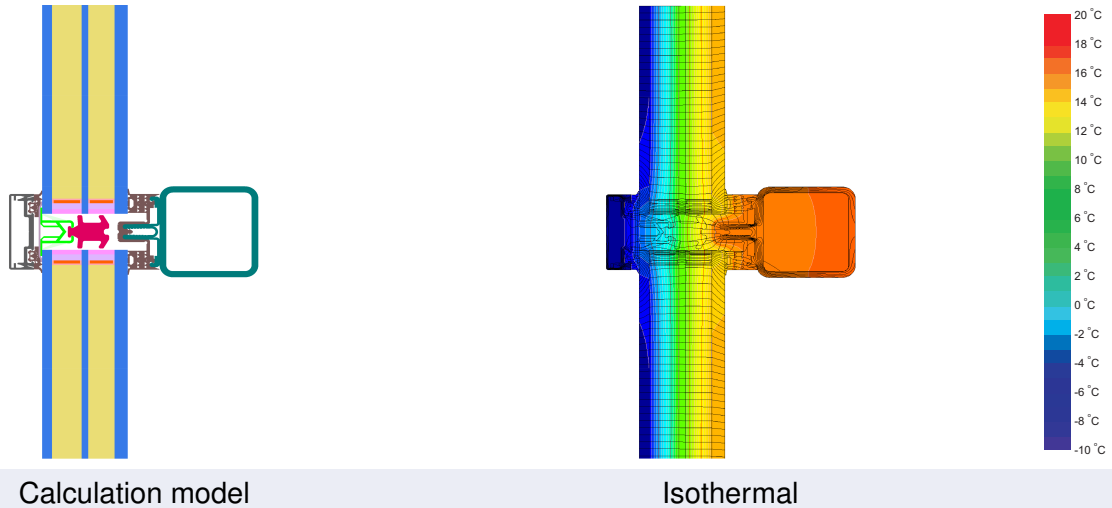

**Description**

Steel construction, with steel system carrier. Covering- and pressure-strip from aluminium. PE-foam insulator in the glazing rebate (0,040 W/(mK)). Screw- and Glass carrier losses measured by ift Rosenheim. Used Pane: 52 mm (6/18/4/16/8), intersection of the Glass: 13 mm. Used spacer: SwisspacerV

**Explanation**





The window U-values were calculated for the test window size of 1.20 m × 2.50 m with  $U_g = 0.70 \text{ W}/(\text{m}^2 \text{ K})$ . If a higher quality glazing is used, the window U-values will improve as follows:

Glazing	$U_g =$	0.72	0.83	0.76	0.68	W/(m <sup>2</sup> K)
		↓	↓	↓	↓	
Element	$U_{CW,i}$	0.81	0.93	0.86	0.79	W/(m <sup>2</sup> K)

Transparent building components are classified into efficiency classes depending on the heat losses through the opaque part. The frame U-Values, frame widths, thermal bridges at the glazing edge, and the glazing edge lengths are included in these heat losses. A more detailed report of the calculations performed in the context of certification is available from the manufacturer.

The Passive House Institute has defined international component criteria for seven climate zones. In principle, components which have been certified for climate zones with higher requirements may also be used in climates with less stringent requirements. In a particular climate zone it may make sense to use a component of a higher thermal quality which has been certified for a climate zone with more stringent requirements.

Further information relating to certification can be found on [www.passivehouse.com](http://www.passivehouse.com) and [passipedia.org](http://passipedia.org).

Frame values			Frame width $b_f$ mm	$U$ -value frame $U_f^1$ W/(m <sup>2</sup> K)	$\Psi$ -glass edge $\Psi_g$ W/(m K)	Temp. Factor $f_{Rsi=0.25}$ [-]
Top fixed	(tof)		50	1.05	0.034	0.79
Side fixed	(sf)		50	1.05	0.034	0.79
Bottom fixed	(bof)		50	1.05	0.034	0.79
Mullion fixed	(m)		50	1.05	0.034	0.79
Transom fixed	(tf)		50	1.05	0.034	0.79
Spacer: SWISSPACER V			Secondary seal: Polysulfide			
Thermal glass carrier bridge <sup>2</sup> $\chi_{GT} = 0.004$ W/K						

## Validated installations

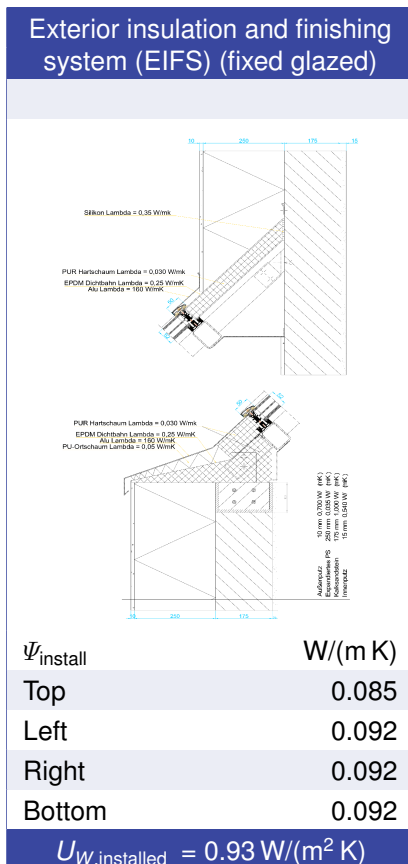

<sup>1</sup> Includes  $\Delta U = 0.22$  W/(m<sup>2</sup> K). \*CWgemessen\*

<sup>2</sup>\*CWgemessen\* . \*CWgctype\* : Non-Metallic Glass Carrier with Screws

