

CERTIFICATE

Certified Passive House Component

Component-ID 0220ic03 valid until 31st December 2018

Passive House Institute
Dr. Wolfgang Feist
64283 Darmstadt
Germany

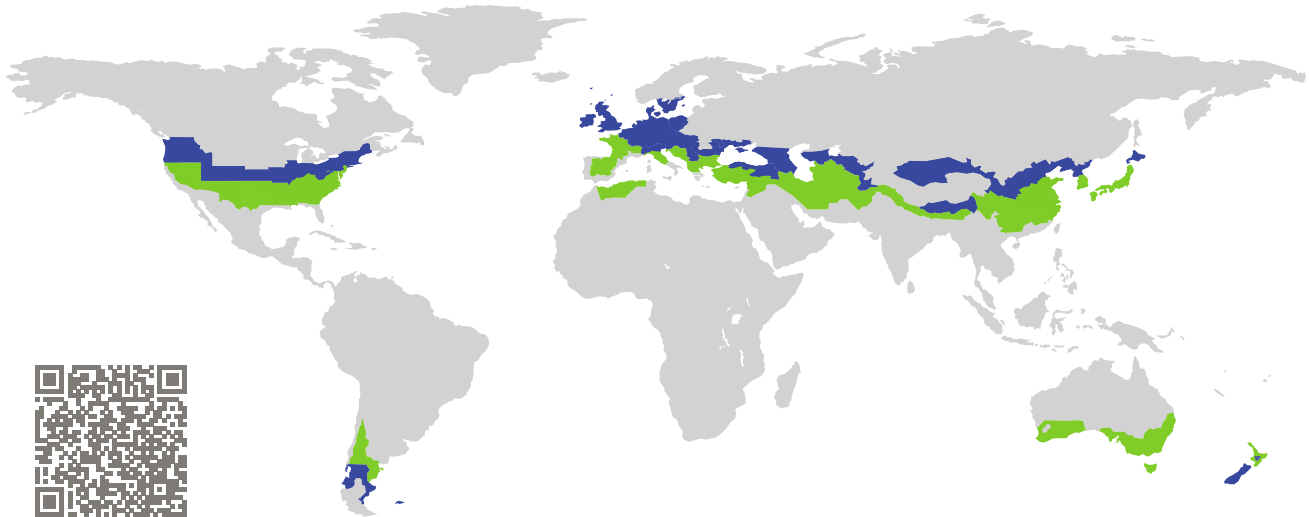

Category: **Glas roof**
Manufacturer: **SCHÜCO International KG,
Bielefeld,
Germany**
Product name: **Schüco AOC 60 TI.SI (schräg)**

**This certificate was awarded based on the following
criteria for the cool, temperate climate zone**

Comfort $U_{CW,i} = 0.83 \leq 1.00 \text{ W}/(\text{m}^2 \text{ K})$
 $U_{CW,i,\text{installed}} \leq 1.00 \text{ W}/(\text{m}^2 \text{ K})$
with $U_g = 0.73 \text{ W}/(\text{m}^2 \text{ K})$

Hygiene $f_{Rsi=0.25} \geq 0.70$

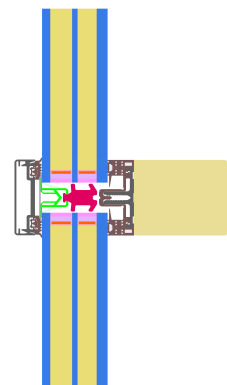

cool, temperate climate



**CERTIFIED
COMPONENT**

Passive House Institute

Passive House
efficiency class

phE

phD

phC

phB

phA

www.passivehouse.com

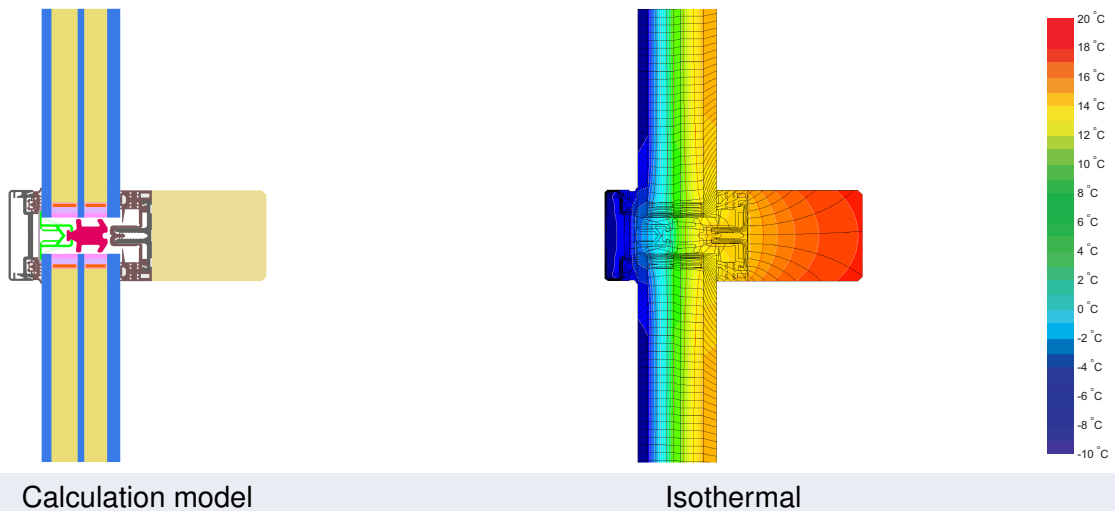

Description

Timber construction, with aluminium system carrier. Covering- and pressure-strip from aluminium. PE-foam insulator in the glazing rebate (0,040 W/(mK)), cover by aluminium foil on the inside. Screw- and Glass carrier losses measured by ift Rosenheim. Used Pane: 48 mm (6/16/4/14/8), intersection of the Glass: 18 mm. Used spacer: Swisspacer V

Explanation





The element U-values were calculated for the test element size of 1.20 m × 2.50 m with $U_g = 0.70 \text{ W}/(\text{m}^2 \text{ K})$. If a higher quality glazing is used, the element U-values will improve as follows:

Glazing	$U_g =$	0.73	0.83	0.76	0.68	W/(m ² K)
		↓	↓	↓	↓	
Element	$U_{CW,i}$	0.83	0.92	0.86	0.78	W/(m ² K)

Transparent building components are sorted into efficiency classes depending on the heat losses through the opaque part. The frame U-Values, frame widths, thermal bridges at the glazing edge and the glazing edge lengths are included in these heat losses. A more detailed report of the calculations performed in the context of certification is available from the manufacturer.

The Passive House Institute has defined international component criteria for seven climate zones. In principle, components that have been certified for climate zones with higher thermal requirements may also be used in climates with less stringent requirements. In a particular climate zone it may make sense to use a component of a higher thermal quality which has been certified for a climate zone with more stringent requirements.

Further information relating to certification can be found on www.passivehouse.com and passipedia.org.

Frame values			Frame width b_f mm	U -value frame U_f^1 W/(m ² K)	Ψ -panel edge Ψ_g W/(m K)	Temp. Factor $f_{Rsi=0.25}$ [-]
Top fixed	(tof)		60	0.92	0.035	0.74
Side fixed	(sf)		60	0.92	0.035	0.74
Bottom fixed	(bof)		60	0.92	0.035	0.74
Mullion fixed	(m)		60	0.92	0.035	0.74
Transom fixed	(tf)		60	0.92	0.035	0.74
			Spacer: SWISSPACER V		Secondary seal: Polysulfide	

Thermal glass carrier bridge ² $\chi_{GT} = 0.004$ W/K

Validated installations

Exterior insulation and finishing system (EIFS) (fixed glazed)

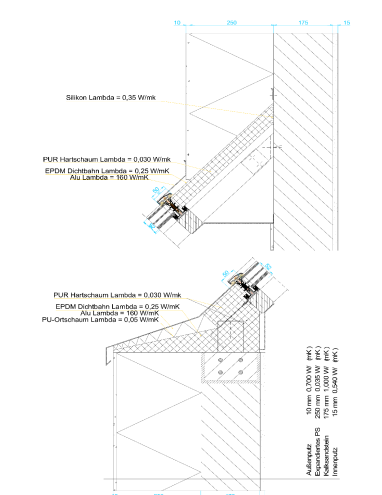

$\Psi_{install}$	W/(m K)
Top	0.087
Left	0.082
Right	0.082
Bottom	0.082

$U_{W,installed} = 0.94$ W/(m² K)

¹ Includes $\Delta U = 0.18$ W/(m² K). Determined through measurement

² Determined through measurement . Glass carrier type : Non-Metallic Glass Carrier with Screws

