

# CERTIFICATE

Certified Passive House Component

Component-ID 1458wc01 valid until 31st December 2020

Passive House Institute  
Dr. Wolfgang Feist  
64283 Darmstadt  
Germany

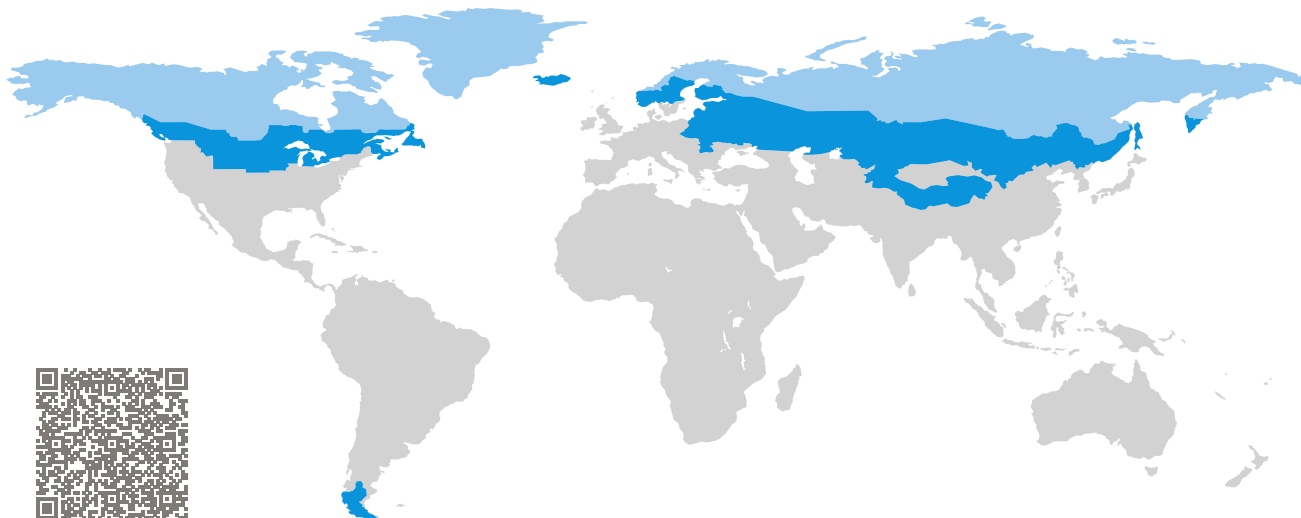

Category: **Window connection**  
Manufacturer: **Hebei Orient Sundar Window Co., Ltd., Gaobeidian City, Hebei Province, China**  
Product name: **All Climate Passive 126 A artic**

**This certificate was awarded based on the following criteria for the arctic climate zone**

Comfort  $U_{W,installed} \leq 0.45 \text{ W}/(\text{m}^2 \text{ K})$   
with  $U_g = 0.35 \text{ W}/(\text{m}^2 \text{ K})$

Hygiene  $f_{Rsi=0.25} \geq 0.80$

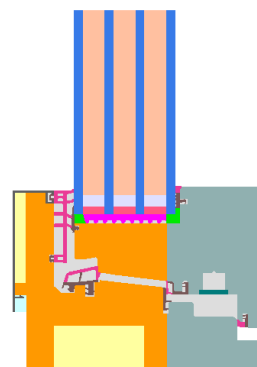

Passive House  
efficiency class

phE

phD

phC

phB

phA

[www.passivehouse.com](http://www.passivehouse.com)

arctic climate



**CERTIFIED  
COMPONENT**

Passive House Institute

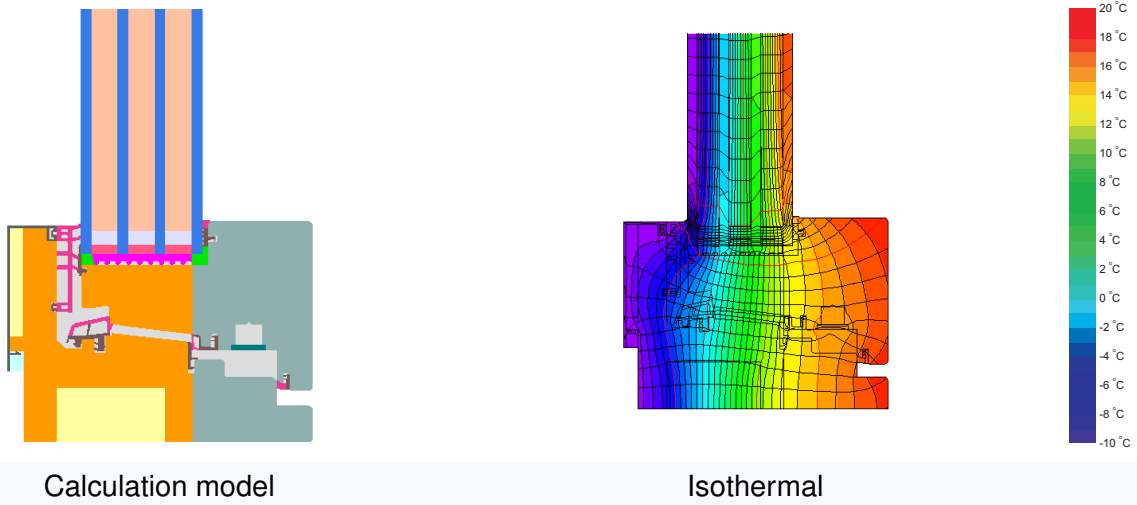

## Description

Timber Aluminium window frame insulated by high rigid EPS, 168 kg/m<sup>3</sup>, 0.043 W/(mK) and resolic foam, 0.023 W/(mK). Pane thickness: 56 mm (5/12/5/24/10), rebate depth: 15 mm. Spacer: MULTI-TECH G with silicone secondary seal.

## Explanation





The window U-values were calculated for the test window size of 1.23 m × 1.48 m with  $U_g = 0.35$  W/(m<sup>2</sup> K). If a higher quality glazing is used, the window U-values will improve as follows:

Glazing	$U_g =$	0.35	0.30	0.40	0.55	W/(m <sup>2</sup> K)
		↓	↓	↓	↓	
Window	$U_W =$	0.43	0.39	0.46	0.57	W/(m <sup>2</sup> K)

Transparent building components are classified into efficiency classes depending on the heat losses through the opaque part. The frame U-Values, frame widths, thermal bridges at the glazing edge, and the glazing edge lengths are included in these heat losses. A more detailed report of the calculations performed in the context of certification is available from the manufacturer.

The Passive House Institute has defined international component criteria for seven climate zones. In principle, components which have been certified for climate zones with higher requirements may also be used in climates with less stringent requirements. In a particular climate zone it may make sense to use a component of a higher thermal quality which has been certified for a climate zone with more stringent requirements.

Further information relating to certification can be found on [www.passivehouse.com](http://www.passivehouse.com) and [passipedia.org](http://passipedia.org).

Frame values			Frame width $b_f$ mm	$U$ -value frame $U_f$ W/(m <sup>2</sup> K)	$\Psi$ -panel edge $\Psi_g$ W/(m K)	Temp. Factor $f_{RSI=0.25}$ [-]
Top	(to)		102	0.43	0.022	0.82
Side	(s)		102	0.43	0.022	0.82
Bottom	(bo)		102	0.43	0.022	0.82
Mullion flying	(fm)		116	0.47	0.022	0.82
Spacer: MULTITECH G			Secondary seal: DOWSIL™ 3364 Warm Edge IG Sealant			

## Validated installations

