

CERTIFICADO

Componente certificado Passive House

ID del componente 1495ws04 válido hasta el 31 de diciembre de 2020

Passive House Institute
Dr. Wolfgang Feist
64283 Darmstadt
Alemania

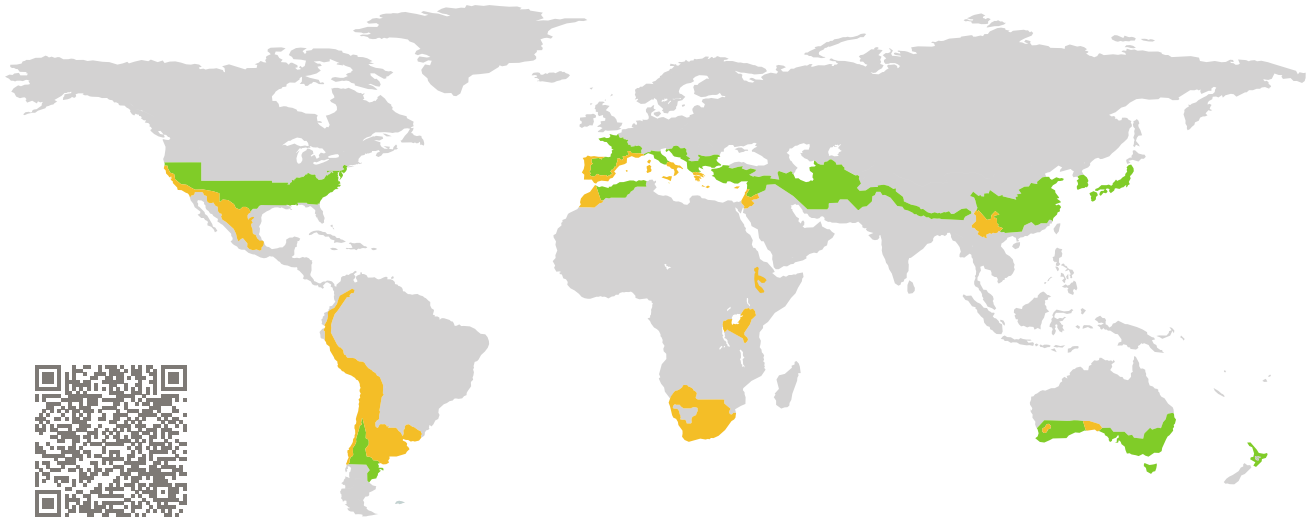

Categoría: **Sistema de ventana**
Fabricante: **INTUS Windows,
Fairfax,
United States of America**
Nombre del producto: **Supera 83 Passive**

Este certificado fue concedido basándose en los siguientes criterios para la zona climática cálida-templada

Confort $U_W = 0,99 \leq 1,00 \text{ W}/(\text{m}^2 \text{ K})$
 $U_{W, \text{installed}} \leq 1,05 \text{ W}/(\text{m}^2 \text{ K})$
con $U_g = 0,90 \text{ W}/(\text{m}^2 \text{ K})$

Higiene $f_{Rsi=0,25} \geq 0,65$
Hermeticidad $Q_{100} = 0,16 \leq 0,25 \text{ m}^3/(\text{h m})$

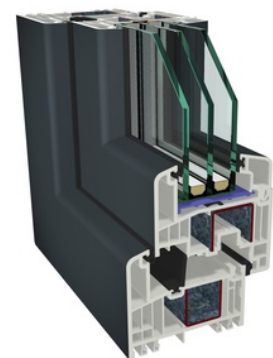

warm, temperate climate



**CERTIFIED
COMPONENT**

Passive House Institute

Passive House
clase eficiencia

phE

phD

phC

phB

phA

www.passivehouse.com

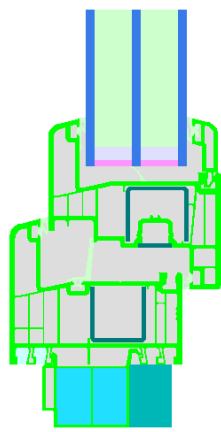

Modelo de cálculo

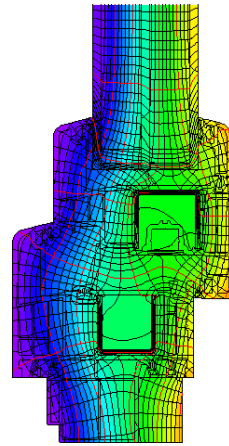

Isotermas

Descripción

Marco de PVC con espuma (IKD® , 0,026 W/(mK)) en la cámara. No se consigue los requisitos del factor de temperatura en la solera. Se certificó la estanquidad al aire en una ventana de dos hojas con batiente de 1650 mm * 1472 mm. Marco 6002 con refuerzo 6715 y ensanche inferior 7202 IKD, hoja 6003 con refuerzo 6706, solera 2596/2576 con 6431 y 6105, poste 6050 con refuerzo 6712. Espesor del acristalamiento 48 mm (4/18/4/18/4), Altura de junquillo: 23 mm.

Explicación

Los valores-U para la ventana fueron calculados para un tamaño de ensayo de 2,46 m × 1,48 m con $U_g = 0,90 \text{ W}/(\text{m}^2 \text{ K})$. Si se utiliza un acristalamiento de mayor calidad, los valores-U de la ventana se incrementarán como sigue:

Acristalamiento	$U_g =$	0,90	0,70	0,64	0,58	W/(m ² K)
		↓	↓	↓	↓	
Ventana	$U_W =$	0,99	0,86	0,82	0,78	W/(m ² K)

Los componentes transparentes del edificio son clasificados en categorías de eficiencia dependiendo de las pérdidas de calor a través de la parte opaca. Los valores-U del marco, anchos del marco, puentes térmicos en el acristalamiento y las longitudes de los bordes del acristalamiento son incluidos en estas pérdidas de calor. El informe detallado con los cálculos efectuados en el contexto de esta certificación está disponible por parte del fabricante.

El Passive House Institute ha definido los criterios internacionales de componentes para siete zonas climáticas. En principio, los componentes que han sido certificados para zonas climáticas con requerimientos más altos pueden ser utilizados también en climas con requisitos menos estrictos. En una zona climática en particular, puede tener sentido utilizar un componente de mayor calidad térmica que haya sido certificado para una zona climática con requisitos más estrictos.

Para mayor información relacionada con la certificación puede visitar www.passivehouse.com y passipedia.org.

Valores del marco			Ancho del marco b_f mm	Valor- U marco U_f W/(m ² K)	Valor- Ψ separador Ψ_g W/(m K)	Factor de temperatura $f_{Rsi=0,25}$ [-]
Superior	(to)		118	1,02	0,023	0,73
Lateral	(s)		118	1,02	0,023	0,73
Inferior	(bo)		148	0,97	0,023	0,73
Superior fijo	(tof)		70	0,96	0,023	0,72
Lateral fijo	(sf)		70	0,96	0,023	0,72
Inferior fijo	(bof)		100	0,91	0,022	0,71
Umbral	(th)		92	1,71	0,023	0,63
Montante fijo	(m)		92	1,05	0,023	0,71
Montante 1 batiente	(m1)		140	1,07	0,023	0,69
Montante 2 batientes	(m2)		188	1,07	0,024	0,68
Travesaño fijo	(tf)		92	1,05	0,023	0,71
Travesaño 1 batiente	(t1)		140	1,07	0,023	0,69
Travesaño 2 batientes	(t2)		188	1,07	0,024	0,68

Separador: SWISSPACER Ultimate

Sellado secundario: Polyurethan



Superior

$b_f = 118,00$ mm

$U_f = 1,02$ W/(m² K)

$\Psi_g = 0,023$ W/(m K)

$f_{Rsi} = 0,73$

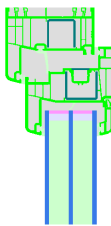
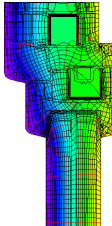

Lateral

$$b_f = 118,00 \text{ mm}$$

$$U_f = 1,02 \text{ W}/(\text{m}^2 \text{ K})$$

$$\Psi_g = 0,023 \text{ W}/(\text{m K})$$

$$f_{Rsi} = 0,73$$

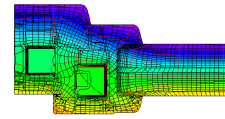
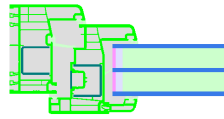

Inferior

$$b_f = 148,00 \text{ mm}$$

$$U_f = 0,97 \text{ W}/(\text{m}^2 \text{ K})$$

$$\Psi_g = 0,023 \text{ W}/(\text{m K})$$

$$f_{Rsi} = 0,73$$

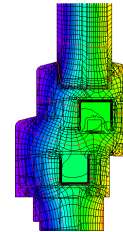
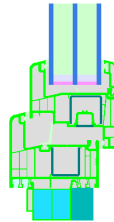

Superior

$$b_f = 70,00 \text{ mm}$$

$$U_f = 0,96 \text{ W}/(\text{m}^2 \text{ K})$$

$$\Psi_g = 0,023 \text{ W}/(\text{m K})$$

$$f_{Rsi} = 0,72$$

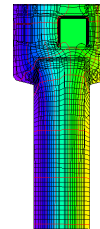
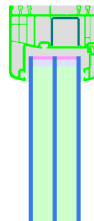

Lateral

$$b_f = 70,00 \text{ mm}$$

$$U_f = 0,96 \text{ W}/(\text{m}^2 \text{ K})$$

$$\Psi_g = 0,023 \text{ W}/(\text{m K})$$

$$f_{Rsi} = 0,72$$

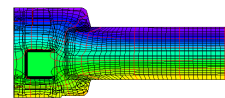
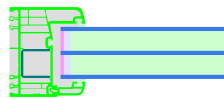

Inferior

$$b_f = 100,00 \text{ mm}$$

$$U_f = 0,91 \text{ W}/(\text{m}^2 \text{ K})$$

$$\Psi_g = 0,022 \text{ W}/(\text{m K})$$

$$f_{Rsi} = 0,71$$

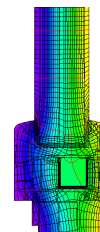
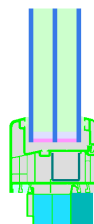



Umbral

$$b_f = 92,00 \text{ mm}$$

$$U_f = 1,71 \text{ W}/(\text{m}^2 \text{ K})$$

$$\Psi_g = 0,023 \text{ W}/(\text{m K})$$

$$f_{Rsi} = 0,63$$

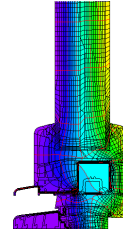
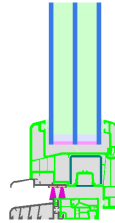

Montante

fijo

$$b_f = 92,00 \text{ mm}$$

$$U_f = 1,05 \text{ W}/(\text{m}^2 \text{ K})$$

$$\Psi_g = 0,023 \text{ W}/(\text{m K})$$

$$f_{Rsi} = 0,71$$

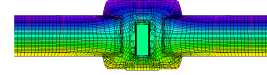
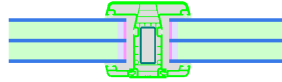

Montante

1 batiente

$$b_f = 140,00 \text{ mm}$$

$$U_f = 1,07 \text{ W}/(\text{m}^2 \text{ K})$$

$$\Psi_g = 0,023 \text{ W}/(\text{m K})$$

$$f_{Rsi} = 0,69$$

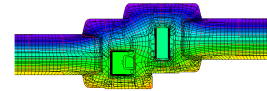
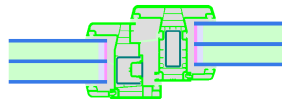

Montante

2 batientes

$$b_f = 188,00 \text{ mm}$$

$$U_f = 1,07 \text{ W}/(\text{m}^2 \text{ K})$$

$$\Psi_g = 0,024 \text{ W}/(\text{m K})$$

$$f_{Rsi} = 0,68$$

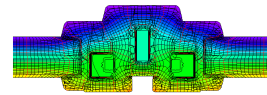

Travesaño

fijo

$$b_f = 92,00 \text{ mm}$$

$$U_f = 1,05 \text{ W}/(\text{m}^2 \text{ K})$$

$$\Psi_g = 0,023 \text{ W}/(\text{m K})$$

$$f_{Rsi} = 0,71$$

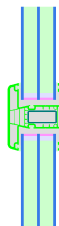



Travesaño

1 batiente

$$b_f = 140,00 \text{ mm}$$

$$U_f = 1,07 \text{ W}/(\text{m}^2 \text{ K})$$

$$\Psi_g = 0,023 \text{ W}/(\text{m K})$$

$$f_{Rsi} = 0,69$$

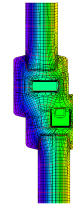

Travesaño

2 batientes

$$b_f = 188,00 \text{ mm}$$

$$U_f = 1,07 \text{ W}/(\text{m}^2 \text{ K})$$

$$\Psi_g = 0,024 \text{ W}/(\text{m K})$$

$$f_{Rsi} = 0,69$$

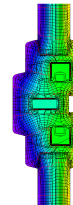

Situaciones de instalación validadas

Bloques encofrado de hormigón (acrist. fijo)

$$U_{\text{Muro}} = 0,25 \text{ W}/(\text{m}^2 \text{ K})$$

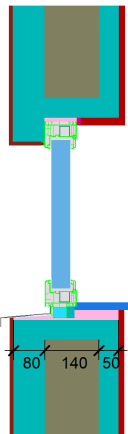

Ψ_{install}	W/(m K)
Superior	-0,007
Izquierda	-0,007
Derecha	-0,007
Inferior	0,012

$$U_{W,\text{installed}} = 0,99 \text{ W}/(\text{m}^2 \text{ K})$$

Bloques encofrado de hormigón (acrist. abatible)

$$U_{\text{Muro}} = 0,25 \text{ W}/(\text{m}^2 \text{ K})$$

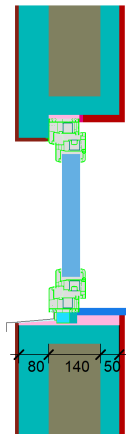

Ψ_{install}	W/(m K)
Superior	-0,004
Izquierda	-0,004
Derecha	-0,004
Inferior	0,015

$$U_{W,\text{installed}} = 1,00 \text{ W}/(\text{m}^2 \text{ K})$$

Estructura ligera de madera (fijo)

$$U_{\text{Muro}} = 0,19 \text{ W}/(\text{m}^2 \text{ K})$$

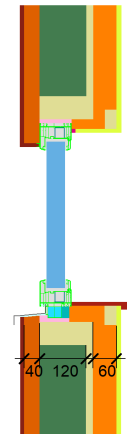

Ψ_{install}	W/(m K)
Superior	0,004
Izquierda	0,004
Derecha	0,004
Inferior	0,012

$$U_{W,\text{installed}} = 1,01 \text{ W}/(\text{m}^2 \text{ K})$$

