

CERTIFICATE

Certified Passive House Component

Component-ID 1143wi05 valid until 31st December 2020

Passive House Institute
Dr. Wolfgang Feist
64283 Darmstadt
Germany

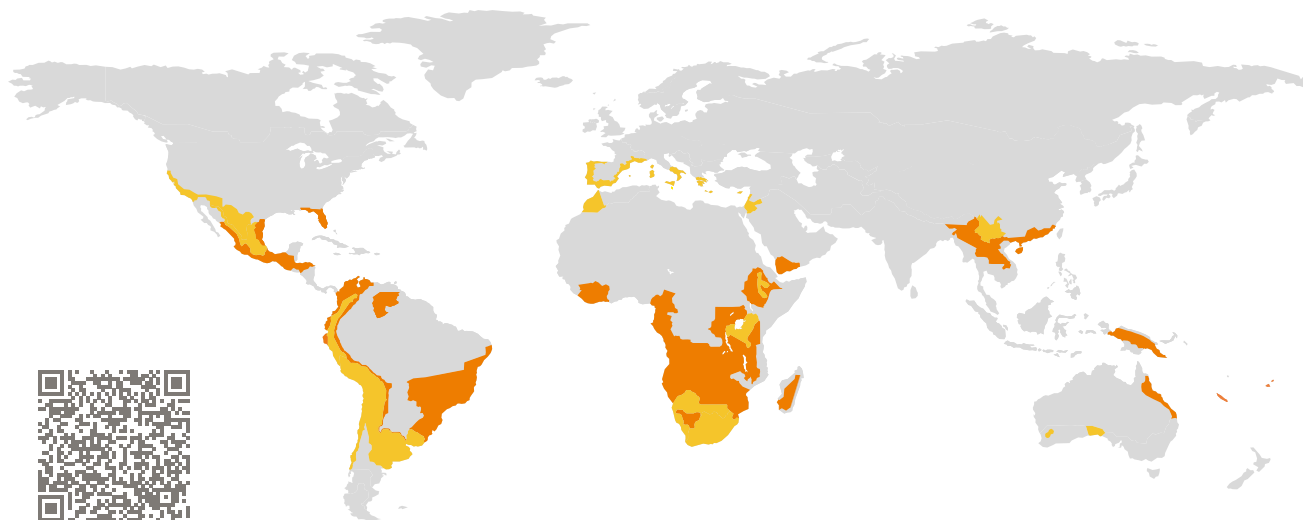

Category: **Window Frame**
Manufacturer: **Logikhaus PTY LTD,
Canberra,
Australia**
Product name: **LogikWin 85**

**This certificate was awarded based on the following
criteria for the warm climate zone**

Comfort $U_W = 1.20 \leq 1.20 \text{ W}/(\text{m}^2 \text{ K})$
 $U_{W,\text{installed}} \leq 1.25 \text{ W}/(\text{m}^2 \text{ K})$
with $U_g = 1.10 \text{ W}/(\text{m}^2 \text{ K})$

Hygiene $f_{Rsi=0.25} \geq 0.55$

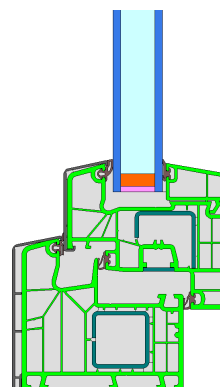

Passive House
efficiency class

phE

phD

phC

phB

phA

www.passivehouse.com

warm climate



**CERTIFIED
COMPONENT**

Passive House Institute

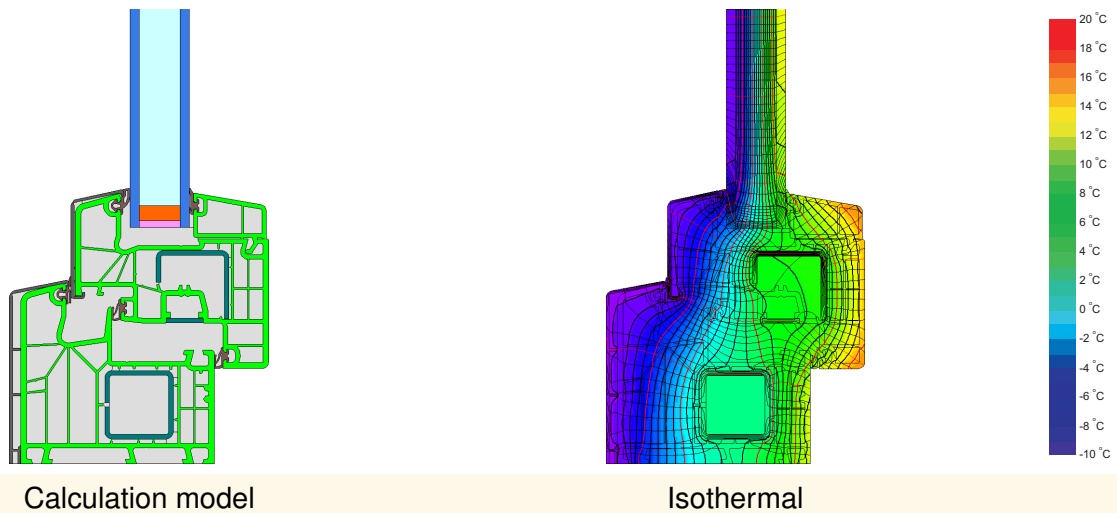

Calculation model Isothermal

Description

Vinyl-frame with aluminium facing-shell and reinforcements inside the sash and blind-frame. Pane thickness: 26 mm (4/18/4//), rebate depth: 16 mm, spacer: Rolltech Multitech

Explanation





The window U-values were calculated for the test window size of 1.23 m × 1.48 m with $U_g = 1.10 \text{ W}/(\text{m}^2 \text{ K})$. If a higher quality glazing is used, the window U-values will improve as follows:

Glazing	$U_g =$	1.10	1.02	1.00	0.90	$\text{W}/(\text{m}^2 \text{ K})$
		↓	↓	↓	↓	
Window	$U_W =$	1.20	1.14	1.13	1.06	$\text{W}/(\text{m}^2 \text{ K})$

Transparent building components are classified into efficiency classes depending on the heat losses through the opaque part. The frame U-Values, frame widths, thermal bridges at the glazing edge, and the glazing edge lengths are included in these heat losses. A more detailed report of the calculations performed in the context of certification is available from the manufacturer.

The Passive House Institute has defined international component criteria for seven climate zones. In principle, components which have been certified for climate zones with higher requirements may also be used in climates with less stringent requirements. In a particular climate zone it may make sense to use a component of a higher thermal quality which has been certified for a climate zone with more stringent requirements.

Further information relating to certification can be found on www.passivehouse.com and passipedia.org.

Frame values			Frame width b_f mm	U -value frame U_f W/(m ² K)	Ψ -panel edge Ψ_g W/(m K)	Temp. Factor $f_{RSi=0.25}$ [-]
Top	(to)		121	1.18	0.029	0.64
Side	(s)		121	1.18	0.029	0.64
Bottom	(bo)		121	1.18	0.029	0.64
Mullion flying	(fm)		162	1.19	0.028	0.62
			Spacer: MULTITECH	Secondary seal: Polysulfid		

Validated installations

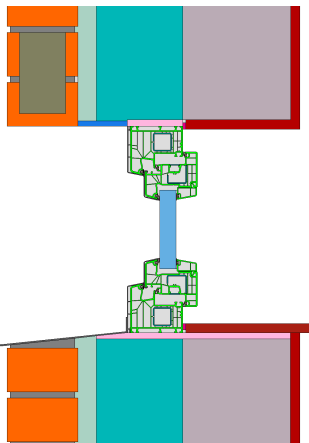
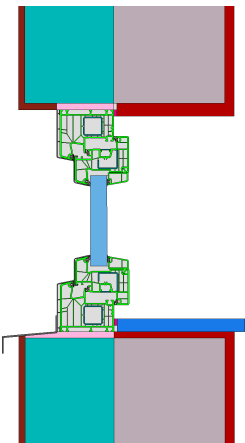
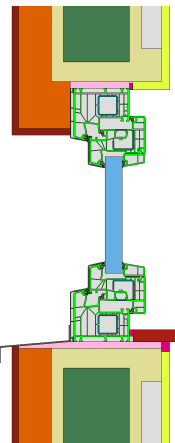
Cavity wall		Exterior insulation and finishing system		Timber frame	
$U_{Wall} = 0.22 \text{ W/(m}^2 \text{ K)}$		$U_{Wall} = 0.23 \text{ W/(m}^2 \text{ K)}$		$U_{Wall} = 0.24 \text{ W/(m}^2 \text{ K)}$	
					
$\Psi_{install}$	W/(m K)	$\Psi_{install}$	W/(m K)	$\Psi_{install}$	W/(m K)
Top	0.013	Top	0.011	Top	0.018
Side	0.013	Side	0.011	Side	0.018
Bottom	0.011	Bottom	0.012	Bottom	0.020
$U_{W,installed} = 1.24 \text{ W/(m}^2 \text{ K)}$		$U_{W,installed} = 1.23 \text{ W/(m}^2 \text{ K)}$		$U_{W,installed} = 1.25 \text{ W/(m}^2 \text{ K)}$	

