

CERTIFICATE

Certified Passive House Component

Component-ID 1361wi04 valid until 31st December 2021

Passive House Institute
Dr. Wolfgang Feist
64283 Darmstadt
Germany

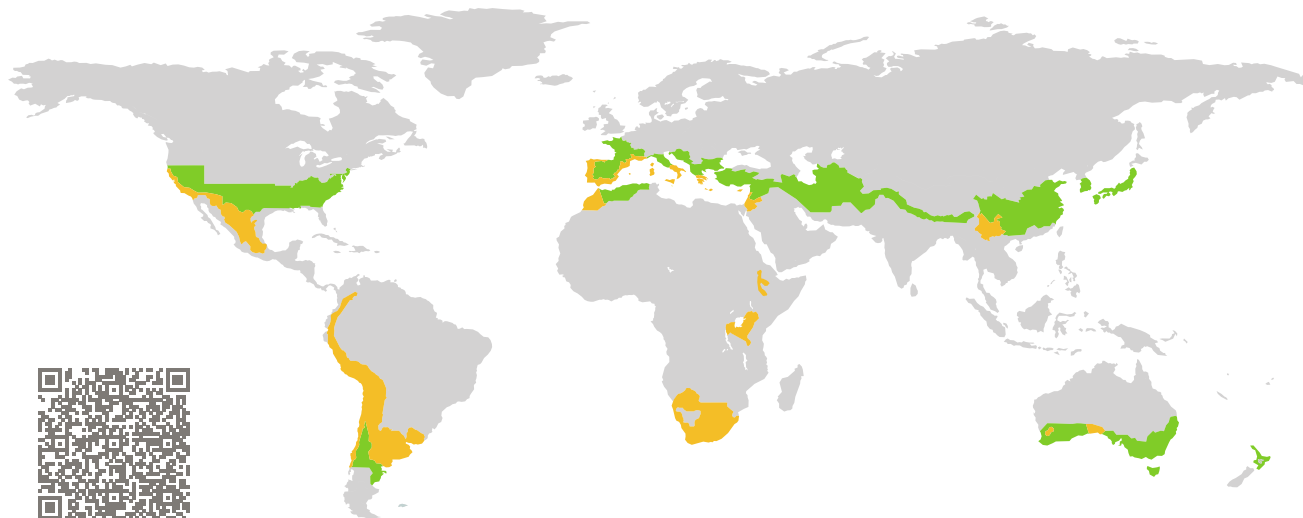

Category: **Window Frame**
Manufacturer: **Shandong Huajian Aluminium Group Co.,LTD, Shandong Province, China**
Product name: **ES91**

This certificate was awarded based on the following criteria for the warm, temperate climate zone

Comfort $U_W = 1.00 \leq 1.00 \text{ W}/(\text{m}^2 \text{ K})$
 $U_{W,\text{installed}} \leq 1.05 \text{ W}/(\text{m}^2 \text{ K})$
with $U_g = 0.90 \text{ W}/(\text{m}^2 \text{ K})$

Hygiene $f_{Rsi=0.25} \geq 0.65$

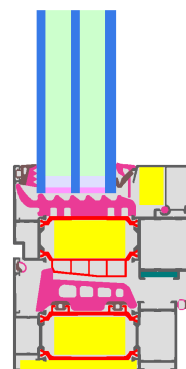

Passive House
efficiency class

phE

phD

phC

phB

phA

warm, temperate climate



ph B



**CERTIFIED
COMPONENT**

Passive House Institute

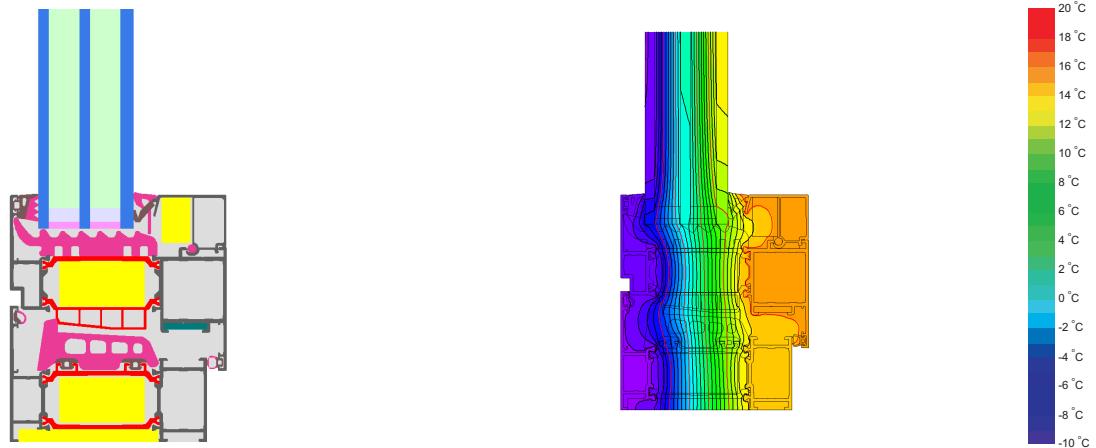

Calculation model

Isothermal

Description

Aluminium frame with thermal separation (PA 0.30 W/(mK)) and insulation (Resol foam 0.022 W/(mK));
 Pane thickness: 44 mm (6/14/5/14/5), rebate depth: 16 mm. Spacer: TGI-Spacer Precision

Explanation





The window U-values were calculated for the test window size of 1.23 m × 1.48 m with $U_g = 0.90$ W/(m² K).
 If a higher quality glazing is used, the window U-values will improve as follows:

Glazing	$U_g =$	0.90	0.80	0.70	0.64	W/(m ² K)
		↓	↓	↓	↓	
Window	$U_W =$	1.00	0.93	0.86	0.82	W/(m ² K)

Transparent building components are classified into efficiency classes depending on the heat losses through the opaque part. The frame U-Values, frame widths, thermal bridges at the glazing edge, and the glazing edge lengths are included in these heat losses. A more detailed report of the calculations performed in the context of certification is available from the manufacturer.

The Passive House Institute has defined international component criteria for seven climate zones. In principle, components which have been certified for climate zones with higher requirements may also be used in climates with less stringent requirements. In a particular climate zone it may make sense to use a component of a higher thermal quality which has been certified for a climate zone with more stringent requirements.

Further information relating to certification can be found on www.passivehouse.com and passipedia.org.

Frame values		Frame width b_f mm	U -value frame U_f W/(m ² K)	Ψ -panel edge Ψ_g W/(m K)	Temp. Factor $f_{RSI=0.25}$ [-]
Top	(to) 	114	0.99	0.028	0.70
Side	(s) 	114	0.99	0.028	0.70
Bottom	(bo) 	114	0.99	0.028	0.70
Mullion flying	(fm) 	138	0.99	0.028	0.70
Spacer: TGI-Spacer Precision			Secondary seal: Polysulfid		

Validated installations

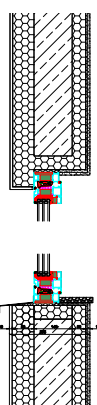
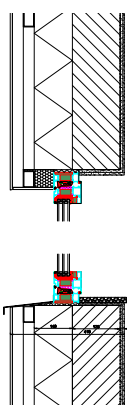
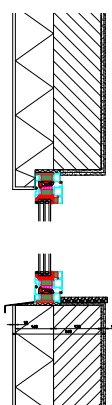
Formwork blocks (operable)		Ventilated facade		Exterior insulation and finishing system (EIFS) (operable)	
$U_{Wall} = 0.25$ W/(m ² K)		$U_{Wall} = 0.23$ W/(m ² K)		$U_{Wall} = 0.23$ W/(m ² K)	
					
$\Psi_{install}$	W/(m K)	$\Psi_{install}$	W/(m K)	$\Psi_{install}$	W/(m K)
Top	0.009	Top	0.010	Top	0.008
Side	0.009	Side	0.010	Side	0.008
Bottom	0.019	Bottom	0.017	Bottom	0.017
$U_{W,installed} = 1.03$ W/(m ² K)		$U_{W,installed} = 1.03$ W/(m ² K)		$U_{W,installed} = 1.03$ W/(m ² K)	

