

CERTIFICATE

Certified Passive House Component

Component-ID 0820wc02 valid until 31st December 2019

Passive House Institute
Dr. Wolfgang Feist
64283 Darmstadt
Germany

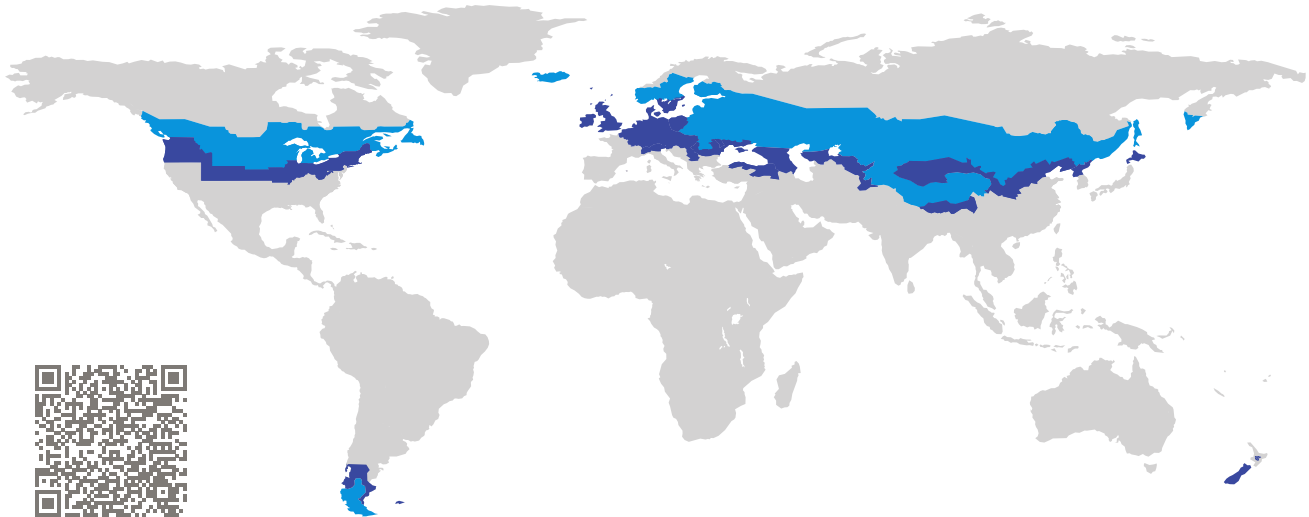

Category: **Window connection**
Manufacturer: **Zola Windows,
Steamboat Springs,
USA**
Product name: **ZNC Arctic**

**This certificate was awarded based on the following
criteria for the cold climate zone**

Comfort $U_{W,installed} \leq 0.65 \text{ W}/(\text{m}^2 \text{ K})$
with $U_g = 0.52 \text{ W}/(\text{m}^2 \text{ K})$

Hygiene $f_{Rsi=0.25} \geq 0.75$

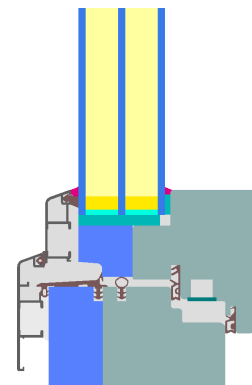

Passive House
efficiency class

phE

phD

phC

phB

phA

www.passivehouse.com

cold climate



ph B

**CERTIFIED
COMPONENT**

Passive House Institute

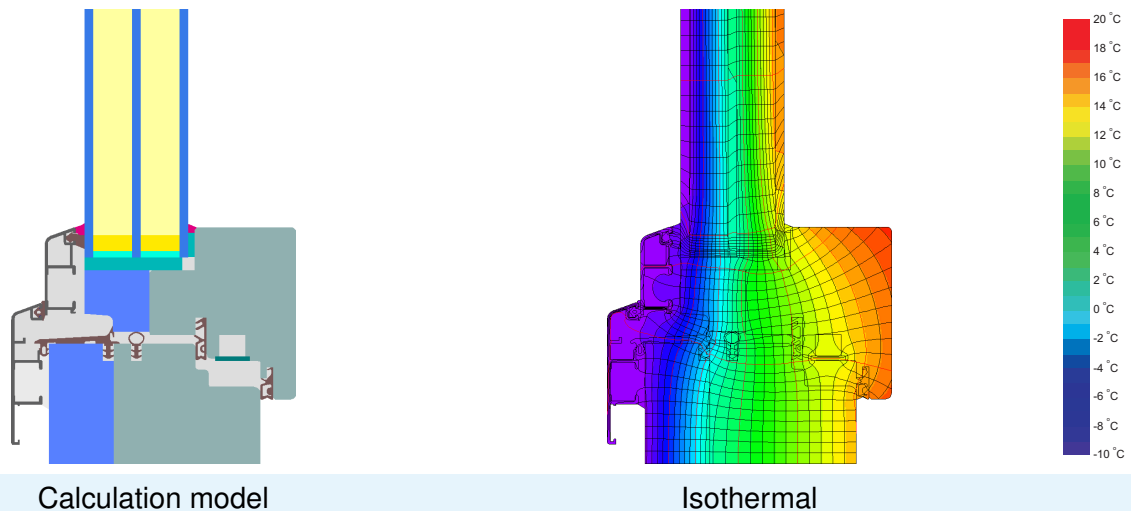

Calculation model Isothermal

Description

Timber-Aluminum frame (Spruce/fir 0,11 W/(mK)), insulated by PU-foam (0,044 W/(mK)). Glazing: 4/18/4/18/4. Spacer: SuperSpacer Tri-Seal with butyl as secondary seal.

Explanation





The window U-values were calculated for the test window size of 1.23 m × 1.48 m with $U_g = 0.52 \text{ W}/(\text{m}^2 \text{ K})$. If a higher quality glazing is used, the window U-values will improve as follows:

Glazing	$U_g =$	0.52	0.64	0.35	0.52	W/(m ² K)
		↓	↓	↓	↓	
Window	$U_W =$	0.64	0.72	0.52	0.64	W/(m ² K)

Transparent building components are classified into efficiency classes depending on the heat losses through the opaque part. The frame U-Values, frame widths, thermal bridges at the glazing edge, and the glazing edge lengths are included in these heat losses. A more detailed report of the calculations performed in the context of certification is available from the manufacturer.

The Passive House Institute has defined international component criteria for seven climate zones. In principle, components which have been certified for climate zones with higher requirements may also be used in climates with less stringent requirements. In a particular climate zone it may make sense to use a component of a higher thermal quality which has been certified for a climate zone with more stringent requirements.

Further information relating to certification can be found on www.passivehouse.com and passipedia.org.

Frame values			Frame width b_f mm	U -value frame U_f W/(m ² K)	Ψ -panel edge Ψ_g W/(m K)	Temp. Factor $f_{Rsi=0.25}$ [-]
Top	(to)		110	0.73	0.023	0.75
Side	(s)		110	0.73	0.023	0.75
Bottom	(bo)		110	0.73	0.023	0.75
Mullion flying	(fm)		134	0.72	0.023	0.75
Spacer: Super Spacer TriSeal / T-Spacer Premium					Secondary seal: Butyl	

Validated installations

