

CERTIFICATE

Certified Passive House Component

Component-ID 0525ed03 valid until 31st December 2018

Passive House Institute
Dr. Wolfgang Feist
64283 Darmstadt
Germany

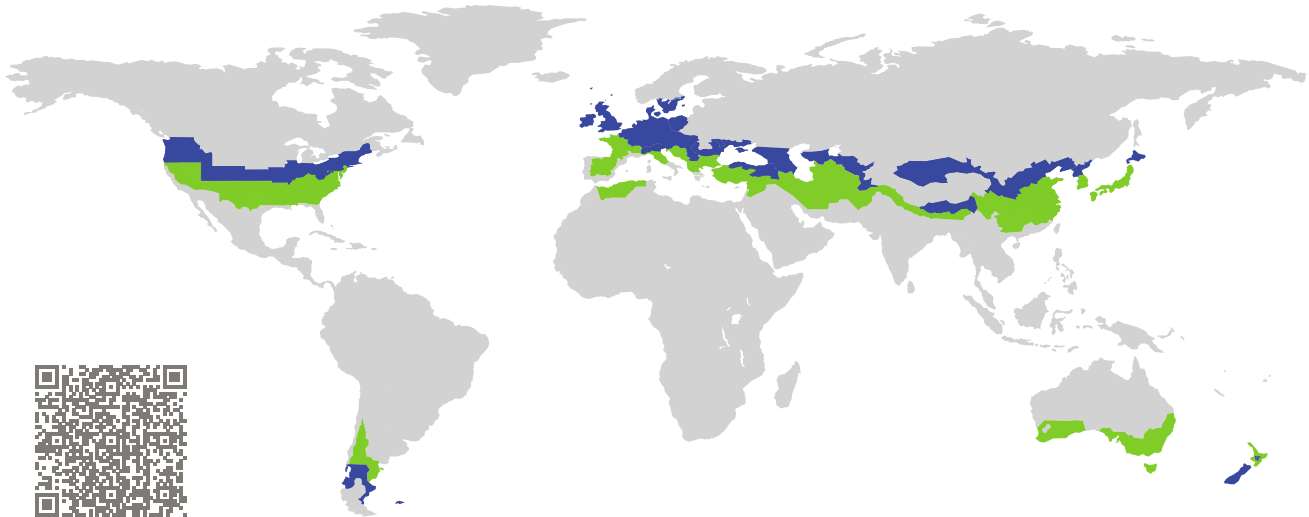

Category: **Entry door (opaque)**
Manufacturer: **Haustüren-Ring GmbH**
Ingolstadt
Germany
Product name: **Öko-Passiv Haustürenrohling 98 mm**

This certificate was awarded based on the following criteria for the cool, temperate climate zone

Comfort $U_D = 0.78 \leq 0.80 \text{ W}/(\text{m}^2 \text{ K})$
 $U_{D,\text{installed}} \leq 0.85 \text{ W}/(\text{m}^2 \text{ K})$
with $U_{\text{door leaf}}^1 = 0.45 \text{ W}/(\text{m}^2 \text{ K})$

Hygiene $f_{Rsi=0.25} \geq 0.70$
Airtightness $Q_{100} \leq 2.25 \text{ m}^3/(\text{h m})$

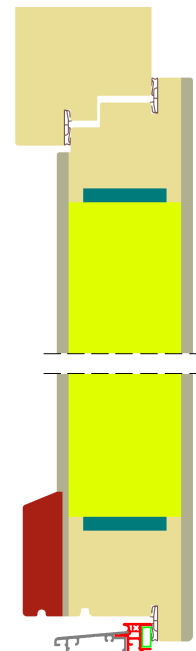

(Inward opening)

¹U-value of the insulated area of door leaf

cool, temperate climate



**CERTIFIED
COMPONENT**

Passive House Institute

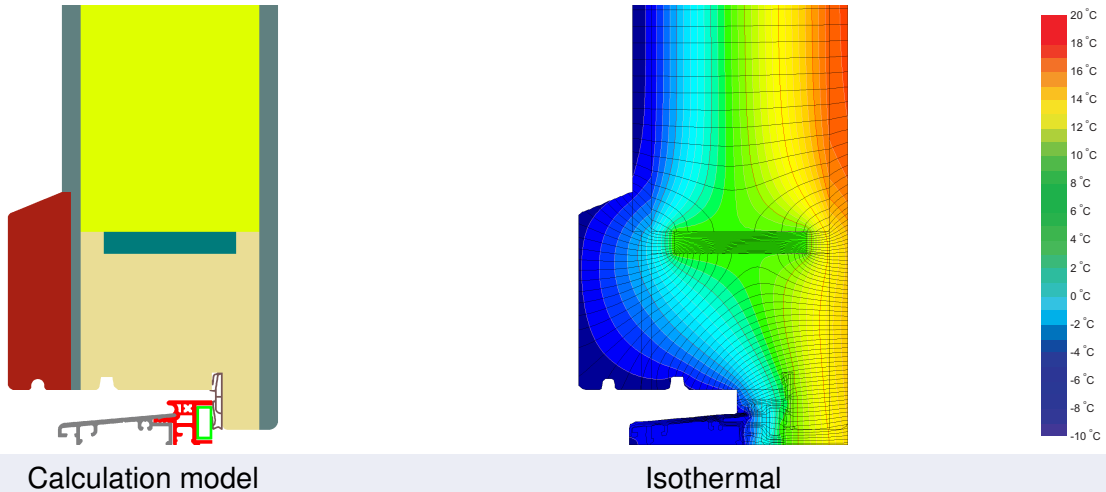

Description

Door frame made of wood profiles 0.13 W/(mK); Door leaf insulation: wood fibers panel insulation 0,041 W/(mK); Threshold: thermally separated aluminum profile, the temperature factor requirement is not met at the threshold.

Explanation



The U-values of the door apply to a door 1.10 m wide by 2.20 m tall.

A detailed report of the calculations performed in the context of certification is available from the manufacturer.

Unless stated otherwise, the air tightness was determined according to EN 1026 with respect to the joint length under climate load in conjunction with EN 1121 for the closed, non-locked door. The result corresponds at least to air-tightness class 3 according to EN 12207.

The Passive House Institute has defined international component criteria for seven climate zones. In principle, components which have been certified for climate zones with higher requirements may also be used in climates with less stringent requirements. In a particular climate zone it may make sense to use a component of a higher thermal quality which has been certified for a climate zone with more stringent requirements.

Further information relating to certification can be found on www.passivehouse.com and passipedia.org.

Frame values			Frame width b_f mm	U -value frame U_f W/(m ² K)	Ψ edge Ψ_g W/(m K)	Temp. Factor $f_{Rsi=0.25}$ [-]
Top	(to)		141	1.21	0.007	-
Threshold	(th)		115	1.65	0.007	-
Hinge side Door	(hs)		141	1.21	0.007	-
Lock side Door	(ls)		199	1.21	0.007	-
			Spacer: -	Secondary seal: -		

 **Top**

$b_f = 141.00 \text{ mm}$
 $U_f = 1.21 \text{ W/(m}^2 \text{ K)}$
 $\Psi_g = 0.007 \text{ W/(m K)}$
 $f_{Rsi} = -$



 **Threshold**

$b_f = 115.00 \text{ mm}$
 $U_f = 1.65 \text{ W/(m}^2 \text{ K)}$
 $\Psi_g = 0.007 \text{ W/(m K)}$
 $f_{Rsi} = -$



 **Hinge side**
Door

$b_f = 141.00 \text{ mm}$
 $U_f = 1.21 \text{ W/(m}^2 \text{ K)}$
 $\Psi_g = 0.007 \text{ W/(m K)}$
 $f_{Rsi} = -$

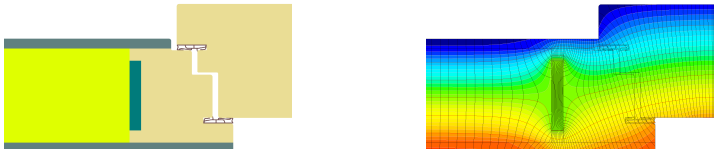

 **Lock side**
Door

$b_f = 199.00 \text{ mm}$
 $U_f = 1.21 \text{ W/(m}^2 \text{ K)}$
 $\Psi_g = 0.007 \text{ W/(m K)}$
 $f_{Rsi} = -$

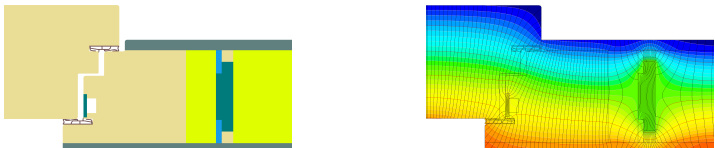

Validated installations

EIFS

$$U_1 = 0.13 \text{ [W/(m}^2 \text{ K)]}$$

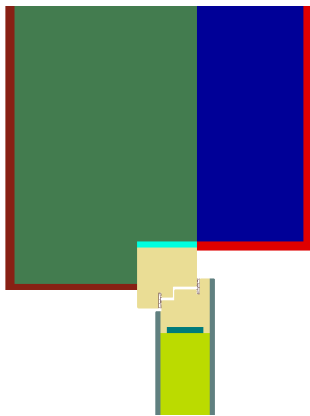

$$\Psi_{\text{install}} = 0.004 \text{ W/(m K)}$$

Threshold entrance door

$$U_1 = 0.13 \quad U_2 = 0.15 \text{ [W/(m}^2 \text{ K)]}$$

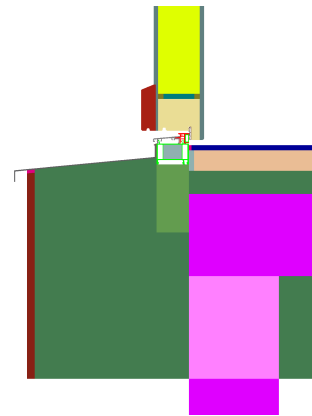

$$\Psi_{\text{install}} = 0.077 \text{ W/(m K)}$$

Timber frame

$$U_1 = 0.14 \text{ [W/(m}^2 \text{ K)]}$$

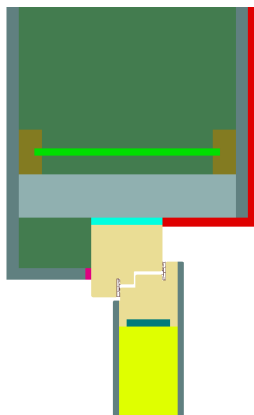

$$\Psi_{\text{install}} = 0.005 \text{ W/(m K)}$$

