

# CERTIFICATE

Certified Passive House Component

Component-ID 0775wi03 valid until 31st December 2018

Passive House Institute  
Dr. Wolfgang Feist  
64283 Darmstadt  
Germany

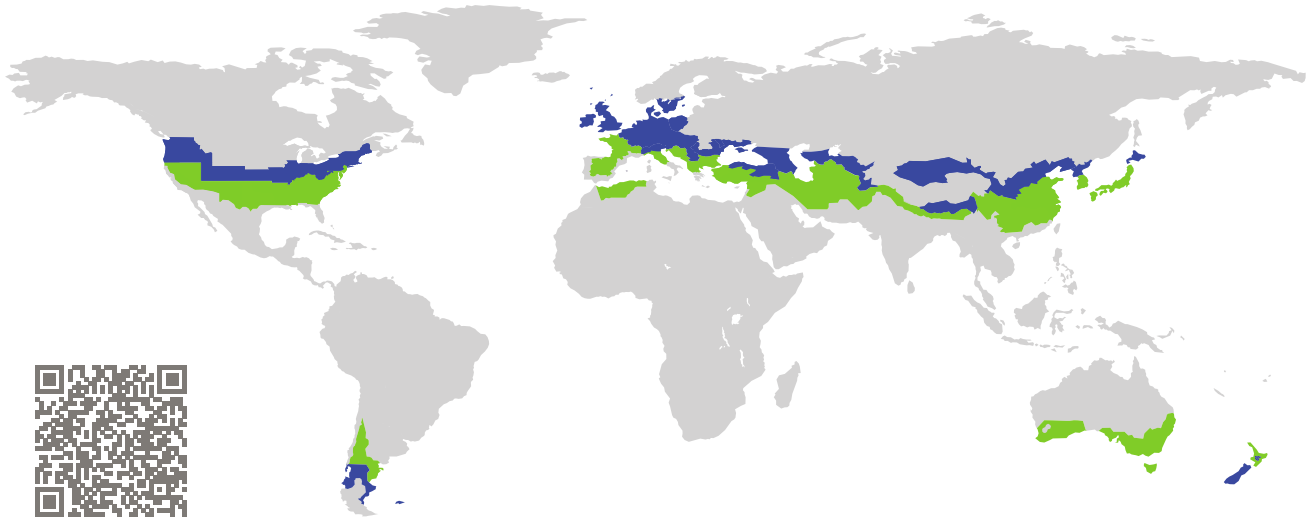

Category: **Window Frame**  
Manufacturer: **Jiangsu Top Composite Technology Co.,Ltd, Suzhou, Jiangsu, People's Republic of China**  
Product name: **GRPU100**

**This certificate was awarded based on the following criteria for the cool, temperate climate zone**

Comfort  $U_W = 0.77 \leq 0.80 \text{ W}/(\text{m}^2 \text{ K})$   
 $U_{W,\text{installed}} \leq 0.85 \text{ W}/(\text{m}^2 \text{ K})$   
with  $U_g = 0.70 \text{ W}/(\text{m}^2 \text{ K})$

Hygiene  $f_{Rsi=0.25} \geq 0.70$

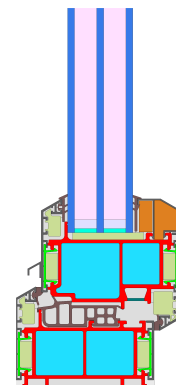

cool, temperate climate



**CERTIFIED COMPONENT**

Passive House Institute

Passive House  
efficiency class

phE

phD

phC

phB

phA

[www.passivehouse.com](http://www.passivehouse.com)

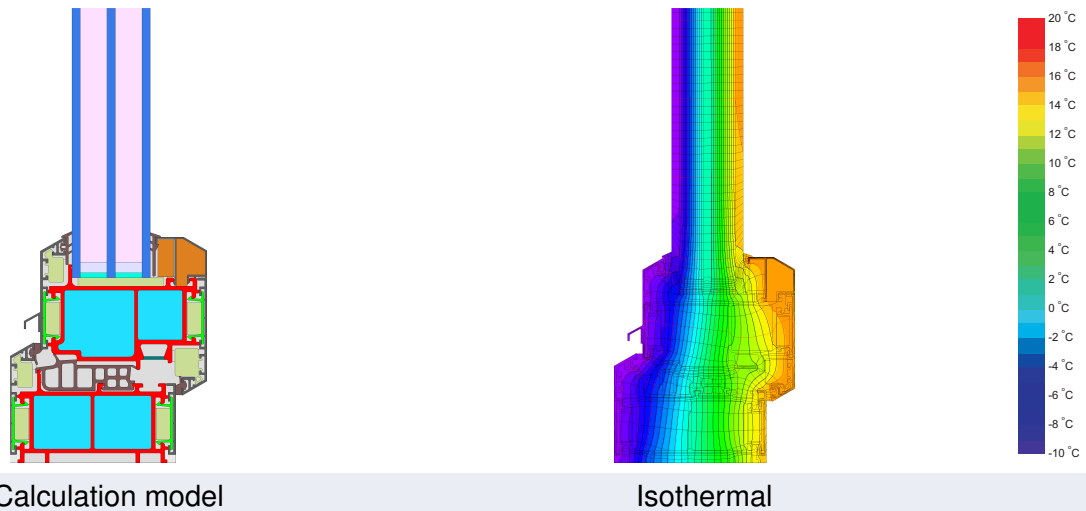

### Description

Windowframe of PU-composite with insulation fillings of polyurethane (0.028 W/(mK)) and polyethylene (0.038 W/(mK)) and facing shells of aluminium. Pane thickness: 47 mm (5/16/5/16/5), rebate depth: 24 mm, spacer: SWISSPACER Ultimate with butyl as secondary seal

### Explanation





The window U-values were calculated for the test window size of 1.23 m × 1.48 m with  $U_g = 0.70 \text{ W}/(\text{m}^2 \text{ K})$ . If a higher quality glazing is used, the window U-values will improve as follows:

Glazing	$U_g =$	0.70	0.64	0.58	0.52	W/(m <sup>2</sup> K)
		↓	↓	↓	↓	
Window	$U_w =$	0.77	0.73	0.69	0.66	W/(m <sup>2</sup> K)

Transparent building components are classified into efficiency classes depending on the heat losses through the opaque part. The frame U-Values, frame widths, thermal bridges at the glazing edge, and the glazing edge lengths are included in these heat losses. A more detailed report of the calculations performed in the context of certification is available from the manufacturer.

The Passive House Institute has defined international component criteria for seven climate zones. In principle, components which have been certified for climate zones with higher requirements may also be used in climates with less stringent requirements. In a particular climate zone it may make sense to use a component of a higher thermal quality which has been certified for a climate zone with more stringent requirements.

Further information relating to certification can be found on [www.passivehouse.com](http://www.passivehouse.com) and [passipedia.org](http://passipedia.org).

Frame values			Frame width $b_f$ mm	$U$ -value frame $U_f$ W/(m <sup>2</sup> K)	$\Psi$ -panel edge $\Psi_g$ W/(m K)	Temp. Factor $f_{Rsi=0.25}$ [-]
Top	(to)		136	0.75	0.022	0.79
Side	(s)		136	0.75	0.022	0.79
Bottom	(bo)		136	0.75	0.022	0.79
Mullion 1 casement	(m1)		255	0.74	0.021	0.79
			Spacer: SWISSPACER Ultimate		Secondary seal: Butyl	

### Validated installations

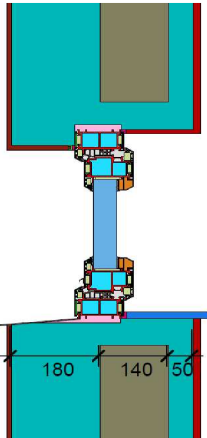
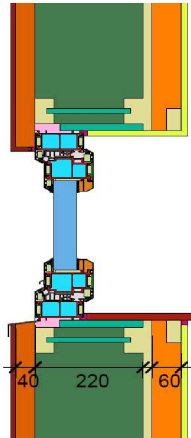
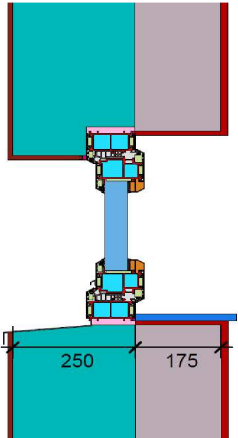
Insulated formwork blocks		Timber frame		EIFS	
					
$\Psi_{install}$	W/(m K)	$\Psi_{install}$	W/(m K)	$\Psi_{install}$	W/(m K)
Top	0.007	Top	0.026	Top	0.007
Side	0.007	Side	0.026	Side	0.007
Bottom	0.013	Bottom	0.031	Bottom	0.017
$U_{W,installed} = 0.80$ W/(m <sup>2</sup> K)		$U_{W,installed} = 0.85$ W/(m <sup>2</sup> K)		$U_{W,installed} = 0.80$ W/(m <sup>2</sup> K)	

