

# CERTIFICATE

Certified Passive House Component

Component-ID 0182ed03 valid until 31st December 2018

Passive House Institute  
Dr. Wolfgang Feist  
64283 Darmstadt  
Germany

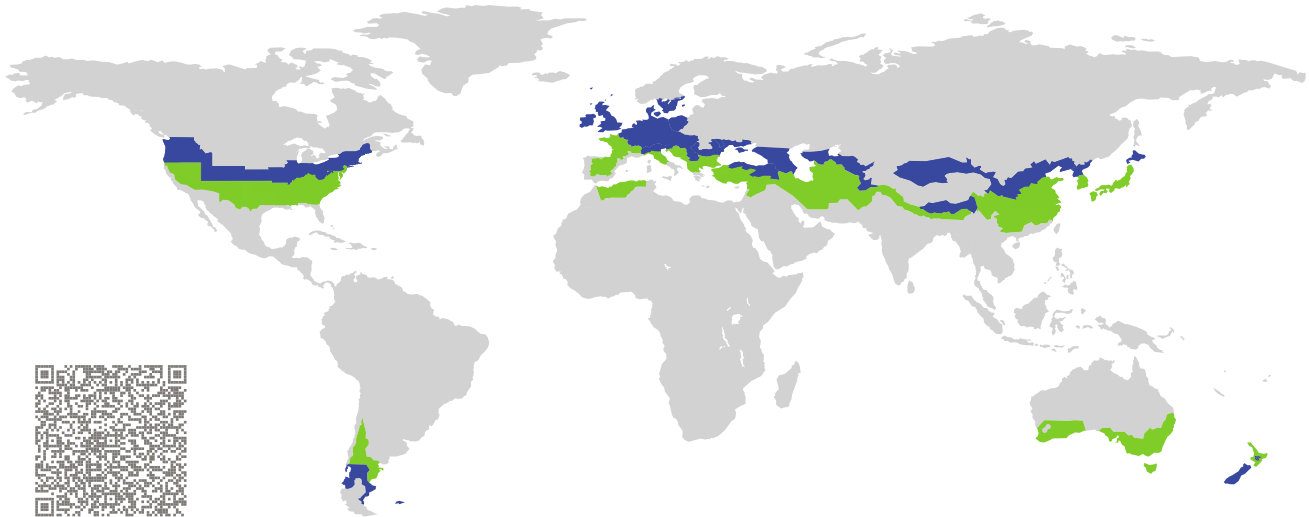

Category: **Entry door (with glas section)**  
Manufacturer: **REHAU AG + Co**  
**Erlangen**  
**Germany**  
Product name: **Haustür GENE0 PHZ, mit Füllung**  
**Güwa einseitig flügelüberdeckend -**  
**Variante ohne Stahlprofile in Türblatt**  
**und Zarge**

**This certificate was awarded based on the following criteria for the cool, temperate climate zone**

Comfort  $U_D = 0.61 \leq 0.80 \text{ W}/(\text{m}^2 \text{ K})$   
 $U_{D,\text{installed}} \leq 0.85 \text{ W}/(\text{m}^2 \text{ K})$   
with  $U_{\text{door leaf}}^1 = 0.36 \text{ W}/(\text{m}^2 \text{ K})$

Hygiene  $f_{Rsi=0.25} \geq 0.70$   
Airtightness  $Q_{100} \leq 2.25 \text{ m}^3/(\text{h m})$

<sup>1</sup>U-value of the insulated area of door leaf

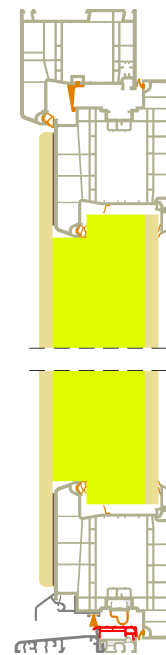

(Inward opening)

cool, temperate climate



**CERTIFIED COMPONENT**

Passive House Institute

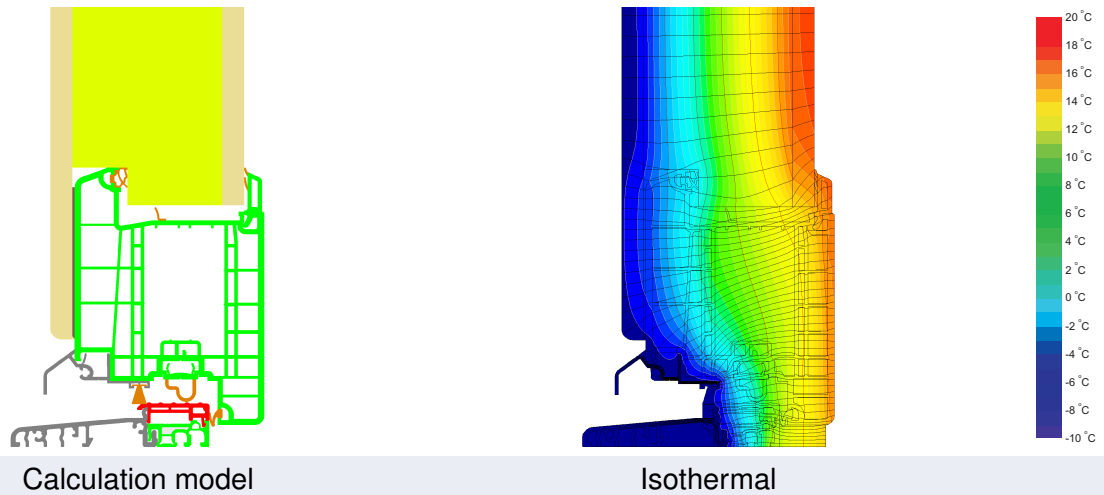

## Description

Door frame made of PVC profiles without reinforcing steel profiles; door leaf (thickness 88 mm) covered by timber-composite panels on both sides; door leaf insulation (thickness 68 mm): PU-foam 0.028 W/(mK); threshold: thermally separated aluminum profile, the temperature factor requirement is not met at the threshold

## Explanation





The U-values of the door apply to a door 1.10 m wide by 2.20 m tall.

A detailed report of the calculations performed in the context of certification is available from the manufacturer.

Unless stated otherwise, the air tightness was determined according to EN 1026 with respect to the joint length under climate load in conjunction with EN 1121 for the closed, non-locked door. The result corresponds at least to air-tightness class 3 according to EN 12207.

The Passive House Institute has defined international component criteria for seven climate zones. In principle, components which have been certified for climate zones with higher requirements may also be used in climates with less stringent requirements. In a particular climate zone it may make sense to use a component of a higher thermal quality which has been certified for a climate zone with more stringent requirements.

Further information relating to certification can be found on [www.passivehouse.com](http://www.passivehouse.com) and [passipedia.org](http://passipedia.org).

Frame values			Frame width $b_f$ mm	$U$ -value frame $U_f$ W/(m <sup>2</sup> K)	$\Psi$ edge $\Psi_g$ W/(m K)	Temp. Factor $f_{Rsi=0.25}$ [-]
Top	(to)		169	0.93	0.001	-
Threshold	(th)		127	1.18	0.001	-
Hinge side Door	(hs)		169	0.93	0.001	-
Lock side Door	(ls)		169	0.93	0.001	-
			Spacer: -	Secondary seal: -		

 **Top**

$b_f = 169.00$  mm  
 $U_f = 0.93$  W/(m<sup>2</sup> K)  
 $\Psi_g = 0.001$  W/(m K)  
 $f_{Rsi} = -$

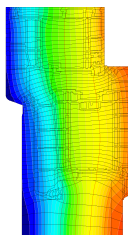
 **Threshold**

$b_f = 127.00$  mm  
 $U_f = 1.18$  W/(m<sup>2</sup> K)  
 $\Psi_g = 0.001$  W/(m K)  
 $f_{Rsi} = -$

 **Hinge side**  
Door

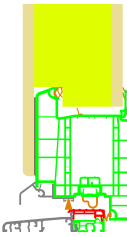
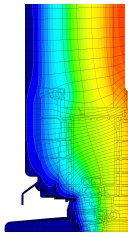
$b_f = 169.00$  mm  
 $U_f = 0.93$  W/(m<sup>2</sup> K)  
 $\Psi_g = 0.001$  W/(m K)  
 $f_{Rsi} = -$

 **Lock side**  
Door

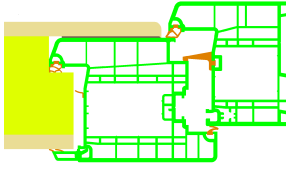
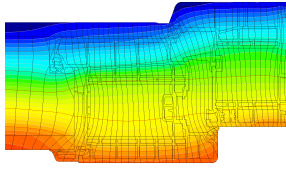
$b_f = 169.00$  mm  
 $U_f = 0.93$  W/(m<sup>2</sup> K)  
 $\Psi_g = 0.001$  W/(m K)  
 $f_{Rsi} = -$

## Door with glas section/infill

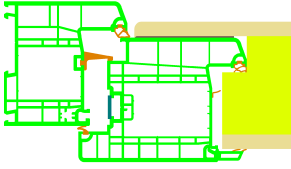
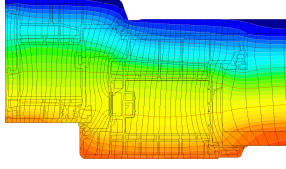
Glazing/Infill : None

$$U_p = 0.55 \text{ W}/(\text{m}^2 \text{ K})$$

$$\Psi = 0.055 \text{ W}/(\text{m K})$$

$$f_{Rsi} = -$$

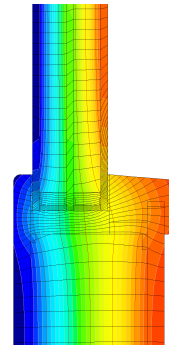
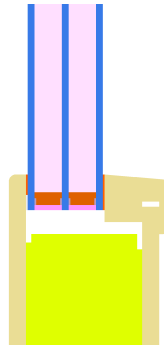

Description:

Glazing (pane structure: 4\*/16Ar/4/16Ar/\*4) with  $U_g = 0.55 \text{ W}/(\text{m}^2 \text{ K})$  according to EN 673; Spacer: "Super Spacer TriSeal"

The comfort criterion limits the use of the infill element as follows:

Maximum area =  $1.05 \text{ m}^2$

Maximum circumference =  $4.74 \text{ m}$

# Validated installations

