

# CERTIFICATE

Certified Passive House Component

Component-ID 1059wi03 valid until 31st December 2018

Passive House Institute  
Dr. Wolfgang Feist  
64283 Darmstadt  
Germany

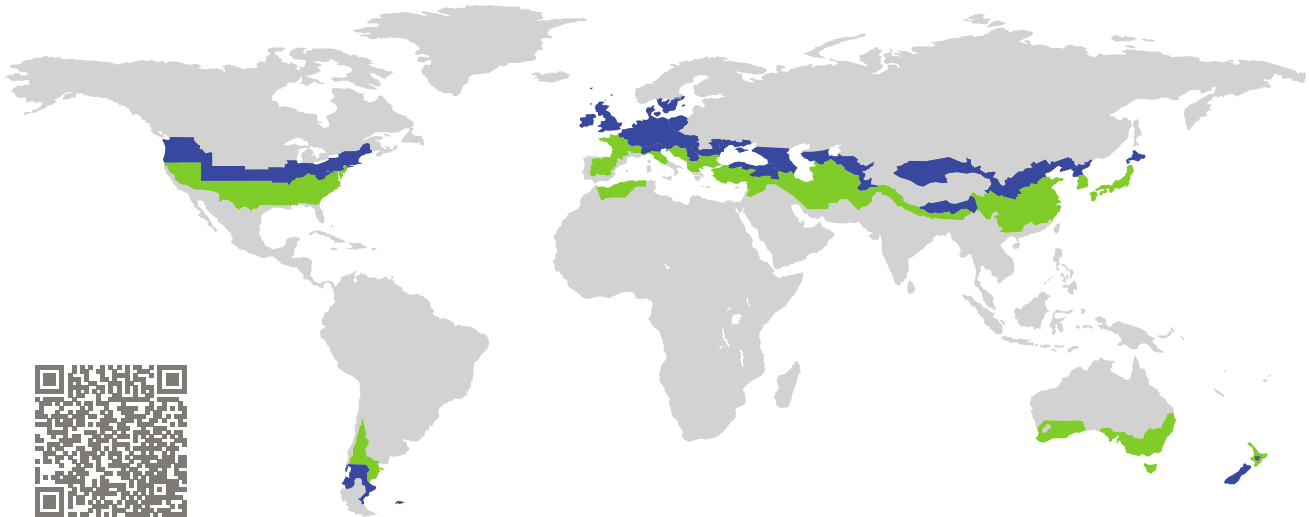

Category: **Window Frame**  
Manufacturer: **Shandong Huajian Aluminium Group Co.,LTD, Shandong Province, People's Republic of China**  
Product name: **ES101**

**This certificate was awarded based on the following criteria for the cool, temperate climate zone**

Comfort  $U_W = 0.79 \leq 0.80 \text{ W}/(\text{m}^2 \text{ K})$   
 $U_{W,\text{installed}} \leq 0.85 \text{ W}/(\text{m}^2 \text{ K})$   
with  $U_g = 0.70 \text{ W}/(\text{m}^2 \text{ K})$

Hygiene  $f_{Rsi=0.25} \geq 0.70$

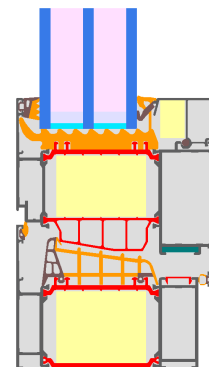

Passive House  
efficiency class

phE

phD

phC

phB

phA

[www.passivehouse.com](http://www.passivehouse.com)

cool, temperate climate



**CERTIFIED  
COMPONENT**

Passive House Institute

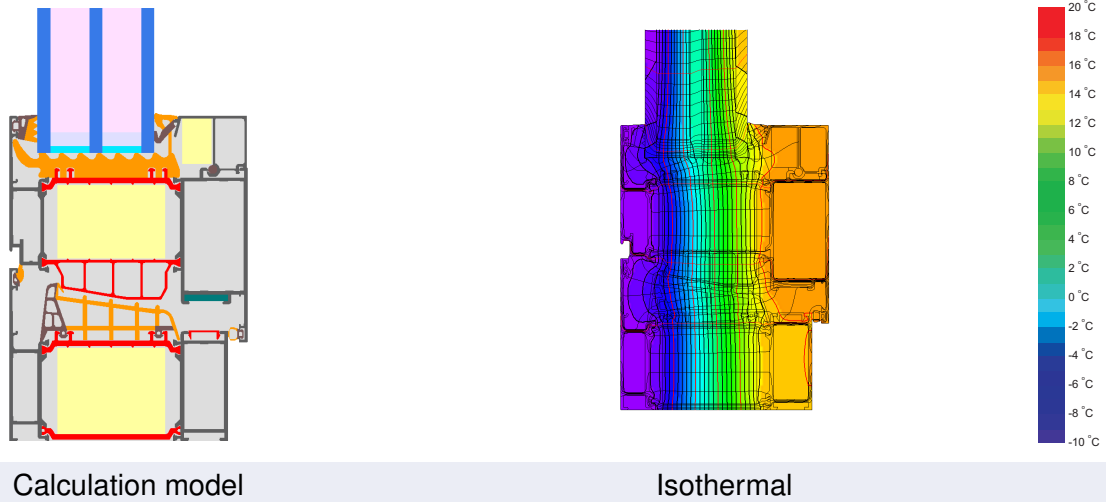

Calculation model Isothermal

### Description

Thermally separated aluminium frame; insulated with resol foam (0,023W/(mK)) Pane thickness: 54 mm (6/18/6/18/6), rebate depth: 17 mm, spacer: SWISSPACER Ultimate with polyurethane as secondary seal

### Explanation





The window U-values were calculated for the test window size of 1.23 m × 1.48 m with  $U_g = 0.70 \text{ W}/(\text{m}^2 \text{ K})$ . If a higher quality glazing is used, the window U-values will improve as follows:

Glazing	$U_g =$	0.70	0.64	0.58	0.52	$\text{W}/(\text{m}^2 \text{ K})$
		↓	↓	↓	↓	
Window	$U_w =$	0.79	0.76	0.72	0.69	$\text{W}/(\text{m}^2 \text{ K})$

Transparent building components are classified into efficiency classes depending on the heat losses through the opaque part. The frame U-Values, frame widths, thermal bridges at the glazing edge, and the glazing edge lengths are included in these heat losses. A more detailed report of the calculations performed in the context of certification is available from the manufacturer.

The Passive House Institute has defined international component criteria for seven climate zones. In principle, components which have been certified for climate zones with higher requirements may also be used in climates with less stringent requirements. In a particular climate zone it may make sense to use a component of a higher thermal quality which has been certified for a climate zone with more stringent requirements.

Further information relating to certification can be found on [www.passivehouse.com](http://www.passivehouse.com) and [passipedia.org](http://passipedia.org).

Frame values			Frame width $b_f$ mm	$U$ -value frame $U_f$ W/(m <sup>2</sup> K)	$\Psi$ -panel edge $\Psi_g$ W/(m K)	Temp. Factor $f_{Rsi=0.25}$ [-]
Top	(to)		150	0.81	0.022	0.76
Side	(s)		150	0.81	0.022	0.76
Bottom	(bo)		150	0.81	0.022	0.76
Mullion flying	(fm)		167	0.81	0.022	0.76
			Spacer: SWISSPACER Ultimate		Secondary seal: Polyurethane	

### Validated installations

**Insulated formwork blocks**

$U_{Wall} = 0.15 \text{ W/(m}^2 \text{ K)}$

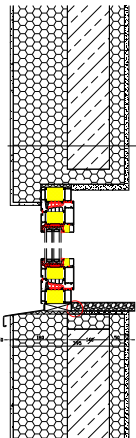

$\Psi_{install}$  W/(m K)

Top	0.012
Side	0.012
Bottom	0.045

$U_{W,installed} = 0.85 \text{ W/(m}^2 \text{ K)}$

**Ventilated facade**

$U_{Wall} = 0.13 \text{ W/(m}^2 \text{ K)}$

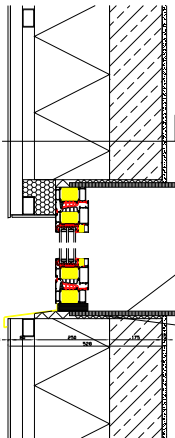

$\Psi_{install}$  W/(m K)

Top	0.017
Side	0.017
Bottom	0.024

$U_{W,installed} = 0.85 \text{ W/(m}^2 \text{ K)}$

**EIFS**

$U_{Wall} = 0.13 \text{ W/(m}^2 \text{ K)}$

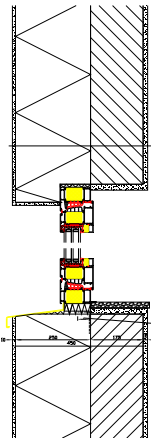

$\Psi_{install}$  W/(m K)

Top	0.014
Side	0.014
Bottom	0.025

$U_{W,installed} = 0.84 \text{ W/(m}^2 \text{ K)}$

