

CERTIFICATE

Certified Passive House Component

Component-ID 1389wi03 valid until 31st December 2025

Passive House Institute
Dr. Wolfgang Feist
64283 Darmstadt
Germany

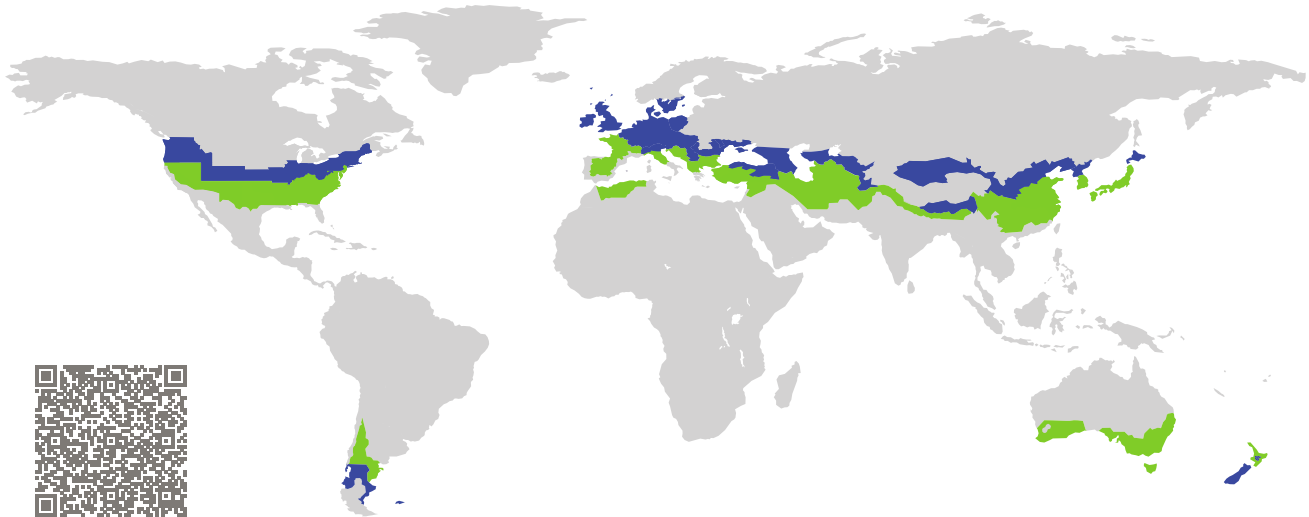

Category: **Window Frame**
Manufacturer: **Harbin Sayyas Windows Stock Co. Ltd.,
Wanggang Town Nangang Distr.
Harbin,
China**
Product name: **PASSIVE 120C-108**

This certificate was awarded based on the following criteria for the cool, temperate climate zone

Comfort $U_W = 0.80 \leq 0.80 \text{ W}/(\text{m}^2 \text{ K})$
 $U_{W, \text{installed}} \leq 0.85 \text{ W}/(\text{m}^2 \text{ K})$
with $U_g = 0.70 \text{ W}/(\text{m}^2 \text{ K})$

Hygiene $f_{Rsi=0.25} \geq 0.70$

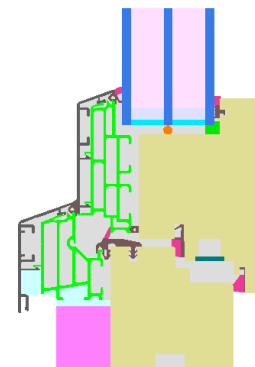

Passive House
efficiency class

phE

phD

phC

phB

phA

www.passivehouse.com

cool, temperate climate



**CERTIFIED
COMPONENT**

Passive House Institute

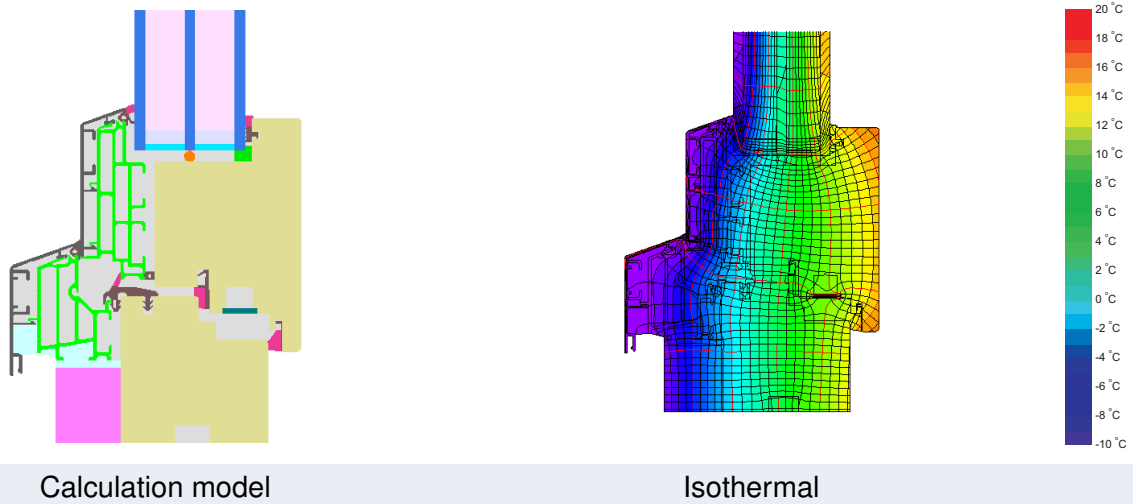

Calculation model Isothermal

Description

Timber-aluminium frame, insulated by EPS-foam (0.032 W/(mK)) and PVC-foam (0.10 W/(mK)). Pane thickness: 51 mm (5/18/5/18/5), rebate depth: 15 mm. Spacer: SWISSPACER Ultimate with polyurethane as secondary seal.

Explanation

The window U-values were calculated for the test window size of 1.23 m × 1.48 m with $U_g = 0.70 \text{ W}/(\text{m}^2 \text{ K})$. If a higher quality glazing is used, the window U-values will improve as follows:

Glazing	$U_g =$	0.70	0.64	0.58	0.52	W/(m ² K)
		↓	↓	↓	↓	
Window	$U_W =$	0.80	0.77	0.73	0.69	W/(m ² K)





Transparent building components are classified into efficiency classes depending on the heat losses through the opaque part. The frame U-Values, frame widths, thermal bridges at the glazing edge, and the glazing edge lengths are included in these heat losses. A more detailed report of the calculations performed in the context of certification is available from the manufacturer.

The Passive House Institute has defined international component criteria for seven climate zones. In principle, components which have been certified for climate zones with higher requirements may also be used in climates with less stringent requirements. In a particular climate zone it may make sense to use a component of a higher thermal quality which has been certified for a climate zone with more stringent requirements.

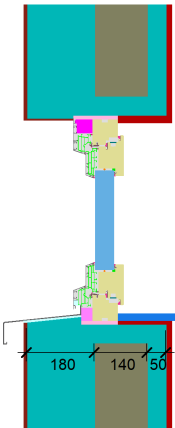
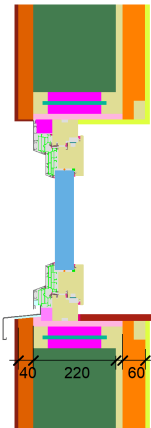
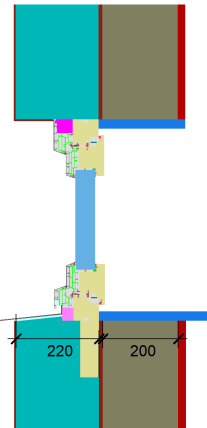
Further information relating to certification can be found on www.passivehouse.com and passipedia.org.

Validated installations

Formwork blocks (operable)	Lightweight timber (operable)	Exterior insulation and finishing system (EIFS) (operable)
$U_{Wall} = 0.15 \text{ W}/(\text{m}^2 \text{ K})$	$U_{Wall} = 0.13 \text{ W}/(\text{m}^2 \text{ K})$	$U_{Wall} = 0.15 \text{ W}/(\text{m}^2 \text{ K})$
		
$\Psi_{install}$ W/(m K)	$\Psi_{install}$ W/(m K)	$\Psi_{install}$ W/(m K)
Top 0.013	Top 0.017	Top 0.010
Side 0.013	Side 0.017	Side 0.010
Bottom 0.027	Bottom 0.017	Bottom 0.027
$U_{W,installed} = 0.85 \text{ W}/(\text{m}^2 \text{ K})$	$U_{W,installed} = 0.85 \text{ W}/(\text{m}^2 \text{ K})$	$U_{W,installed} = 0.84 \text{ W}/(\text{m}^2 \text{ K})$

Frame values		Frame width b_f mm	U -value frame U_f W/(m ² K)	Ψ -glazing edge Ψ_g W/(m K)	Temp. Factor $f_{Rsi=0.25}$ [-]
Mullion 2 casements	(2M1) 	254	0.84	0.021	0.75
Bottom	(OB1) 	155	0.91	0.021	0.75
Top	(OH1) 	155	0.80	0.021	0.76
Lateral	(OJ1) 	155	0.80	0.021	0.76
Spacer: SWISSPACER Ultimate			Secondary seal:		

