

CERTIFICATE

Certified Passive House Component

Component-ID 1397sl03 valid until 31st December 2025

Passive House Institute
Dr. Wolfgang Feist
64283 Darmstadt
Germany

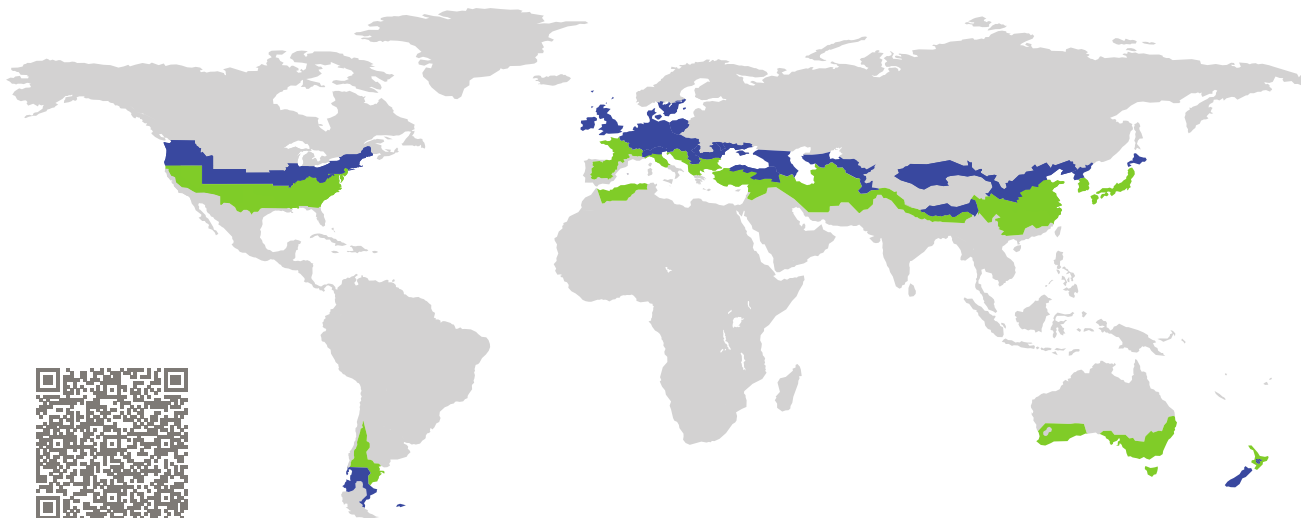

Category: **Sliding Door**
Manufacturer: **ENERsign GmbH,
Wittlich,
Germany**
Product name: **ENERsign primus slide**

**This certificate was awarded based on the following
criteria for the cool, temperate climate zone**

Comfort $U_{SL} = 0.78 \leq 0.80 \text{ W}/(\text{m}^2 \text{ K})$
 $U_{SL, \text{installed}} \leq 0.85 \text{ W}/(\text{m}^2 \text{ K})$
with $U_g = 0.70 \text{ W}/(\text{m}^2 \text{ K})$

Hygiene $f_{Rsi=0.25} \geq 0.70$

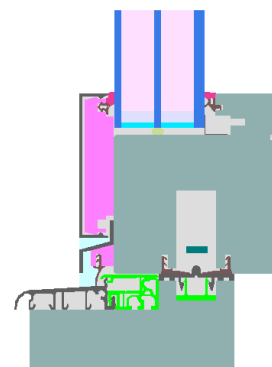

cool, temperate climate



**CERTIFIED
COMPONENT**

Passive House Institute

Passive House
efficiency class

phE

phD

phC

phB

phA

www.passivehouse.com

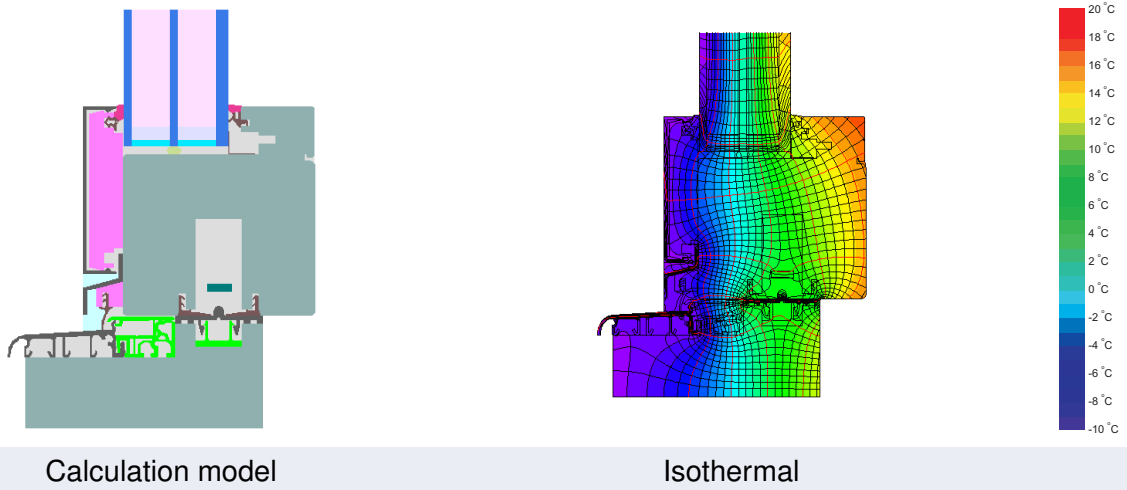
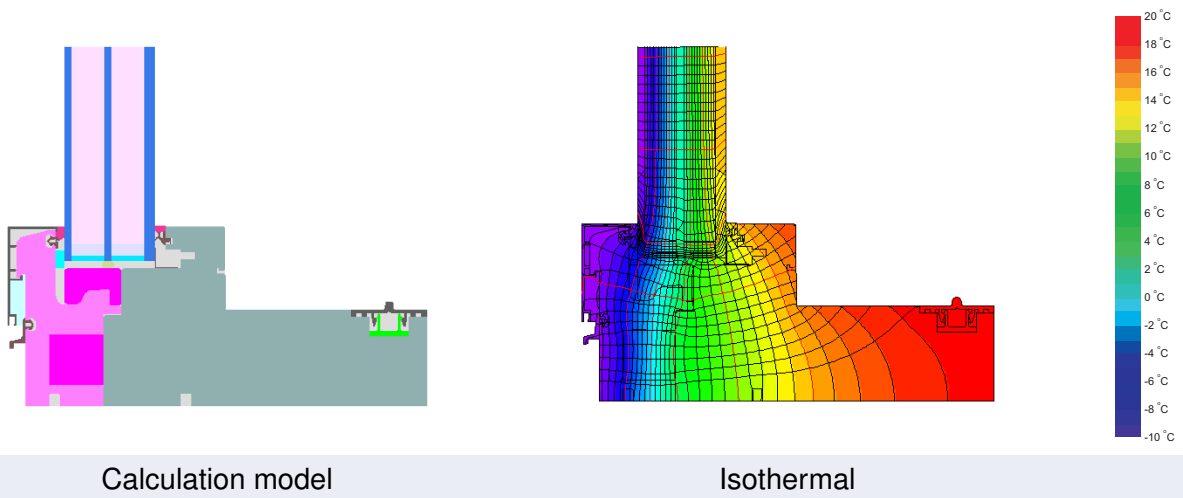

Description

Aluminium clad timber frame (0,11 W/(mK)), insulated by EPS-Foam (0,032 W/(mK)) and ENERcell (0,06 W/(mK)). Pane thickness: 50 mm (4/18/4/18/6), rebate depth: 19 mm. Spacer: SWISSPACER Ultimate with polyurethane as secondary seal.

Explanation







The window U-values were calculated for the test window size of 2.40 m × 2.50 m with $U_g = 0.70 \text{ W}/(\text{m}^2 \text{ K})$. If a higher quality glazing is used, the window U-values will improve as follows:

Glazing	$U_g =$	0.70	0.64	0.58	0.52	W/(m ² K)
		↓	↓	↓	↓	
Window	$U_w =$	0.78	0.73	0.69	0.64	W/(m ² K)

Transparent building components are classified into efficiency classes depending on the heat losses through the opaque part. The frame U-Values, frame widths, thermal bridges at the glazing edge, and the glazing edge lengths are included in these heat losses. A more detailed report of the calculations performed in the context of certification is available from the manufacturer.

The Passive House Institute has defined international component criteria for seven climate zones. In principle, components which have been certified for climate zones with higher requirements may also be used in climates with less stringent requirements. In a particular climate zone it may make sense to use a component of a higher thermal quality which has been certified for a climate zone with more stringent requirements.

Further information relating to certification can be found on www.passivehouse.com and passipedia.org.

Frame values			Frame width b_f mm	U-value frame U_f W/(m ² K)	Ψ -glazing edge Ψ_g W/(m K)	Temp. Factor $f_{Rsi=0.25}$ [-]
Mullion 1 casement	(1M1)		123	1.20	0.022	0.70
Bottom fixed	(FB1)		100	0.55	0.019	0.76
Top fixed	(FH1)		100	0.56	0.019	0.76
Lateral fixed	(FJ1)		100	0.54	0.019	0.75
Top	(OH1)		148	0.89	0.019	0.76
Lateral	(OJ1)		165	0.78	0.019	0.74
Threshold	(OT2)		154	1.11	0.019	0.73

Spacer: SWISSPACER Ultimate Secondary seal: Polyurethan



Mullion
1 casement

$b_f = 123 \text{ mm}$
 $U_f = 1.20 \text{ W/(m}^2 \text{ K)}$
 $\Psi_g = 0.022 \text{ W/(m K)}$
 $f_{Rsi} = 0.70$

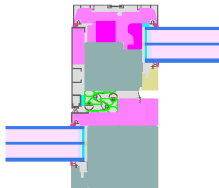
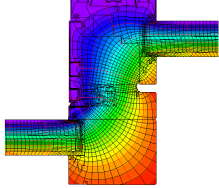

Bottom
fixed

$b_f = 100 \text{ mm}$
 $U_f = 0.55 \text{ W/(m}^2 \text{ K)}$
 $\Psi_g = 0.019 \text{ W/(m K)}$
 $f_{Rsi} = 0.76$

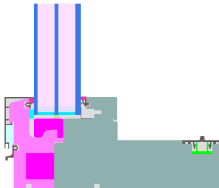
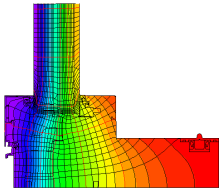

Top
fixed

$$b_f = 100 \text{ mm}$$

$$U_f = 0.56 \text{ W/(m}^2 \text{ K)}$$

$$\Psi_g = 0.019 \text{ W/(m K)}$$

$$f_{Rsi} = 0.76$$

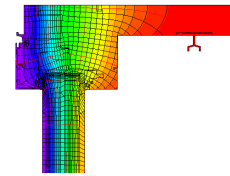
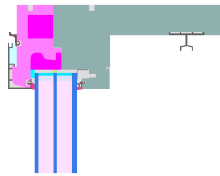

Lateral
fixed

$$b_f = 100 \text{ mm}$$

$$U_f = 0.54 \text{ W/(m}^2 \text{ K)}$$

$$\Psi_g = 0.019 \text{ W/(m K)}$$

$$f_{Rsi} = 0.75$$

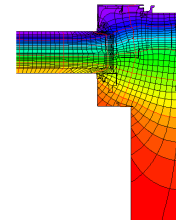
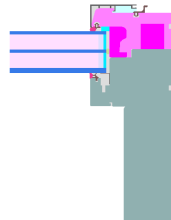

Top

$$b_f = 148 \text{ mm}$$

$$U_f = 0.89 \text{ W/(m}^2 \text{ K)}$$

$$\Psi_g = 0.019 \text{ W/(m K)}$$

$$f_{Rsi} = 0.76$$

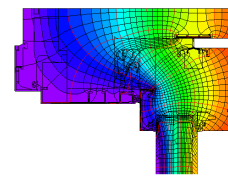
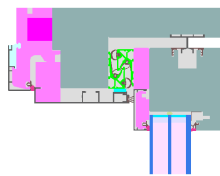

Lateral

$$b_f = 165 \text{ mm}$$

$$U_f = 0.78 \text{ W/(m}^2 \text{ K)}$$

$$\Psi_g = 0.019 \text{ W/(m K)}$$

$$f_{Rsi} = 0.74$$

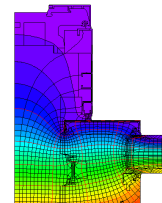
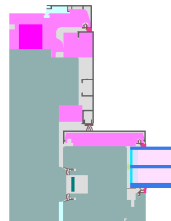

Threshold

$$b_f = 154 \text{ mm}$$

$$U_f = 1.11 \text{ W/(m}^2 \text{ K)}$$

$$\Psi_g = 0.019 \text{ W/(m K)}$$

$$f_{Rsi} = 0.73$$

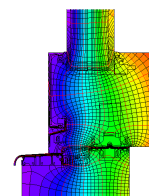
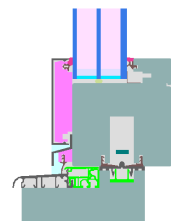

Validated installations

Exterior insulation and finishing s (EIFS)
top (fixed glazing)

$U_1 = 0.13 \text{ [W/(m}^2 \text{ K)]}$

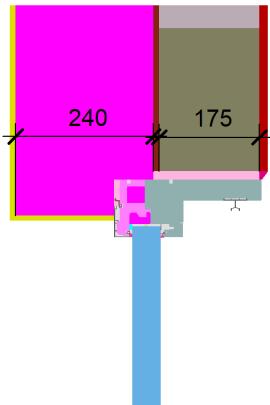

$\Psi_{\text{install}} = 0.01 \text{ W/(m K)}$

Exterior insulation and finishing s (EIFS)
top (operable)

$U_1 = 0.13 \text{ [W/(m}^2 \text{ K)]}$

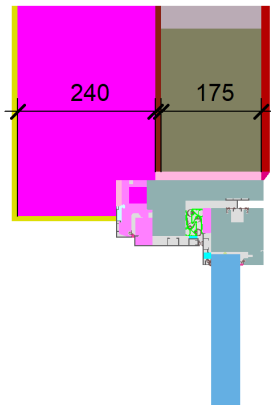

$\Psi_{\text{install}} = 0.05 \text{ W/(m K)}$

Ext insulation a. finish. s. (EIFS)
threshold ceiling (operable)

$U_1 = 0.13 \text{ [W/(m}^2 \text{ K)]}$

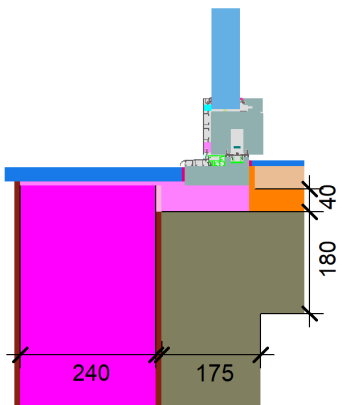

$\Psi_{\text{install}} = 0.14 \text{ W/(m K)}$

Ext insulation a. finish. s. (EIFS)
threshold ceiling (fixed gl)

$U_1 = 0.13 \text{ [W/(m}^2 \text{ K)]}$

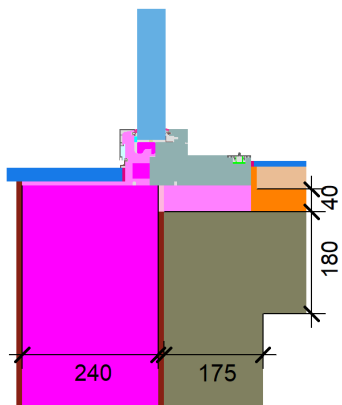

$\Psi_{\text{install}} = 0.02 \text{ W/(m K)}$

Exterior insulation and finishing s (EIFS)
side (fixed glazed)

$U_1 = 0.13 \text{ [W/(m}^2 \text{ K)]}$

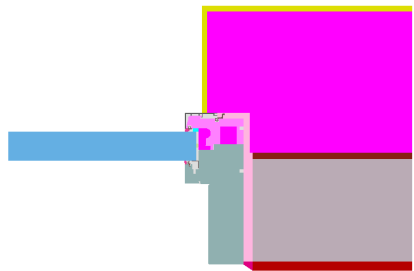

$\Psi_{\text{install}} = 0.01 \text{ W/(m K)}$

Exterior insulation and finishing system
(EIFS) side (operable)

$U_1 = 0.13 \text{ [W/(m}^2 \text{ K)]}$

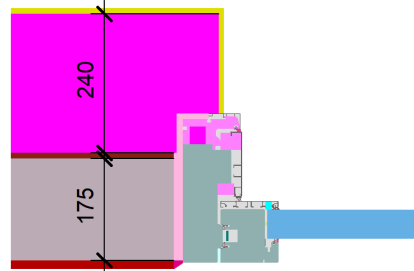

$\Psi_{\text{install}} = 0.08 \text{ W/(m K)}$

