

CERTIFICATE

Certified Passive House Component

Component-ID 0872wi04 valid until 31st December 2025

Passive House Institute
Dr. Wolfgang Feist
64283 Darmstadt
Germany

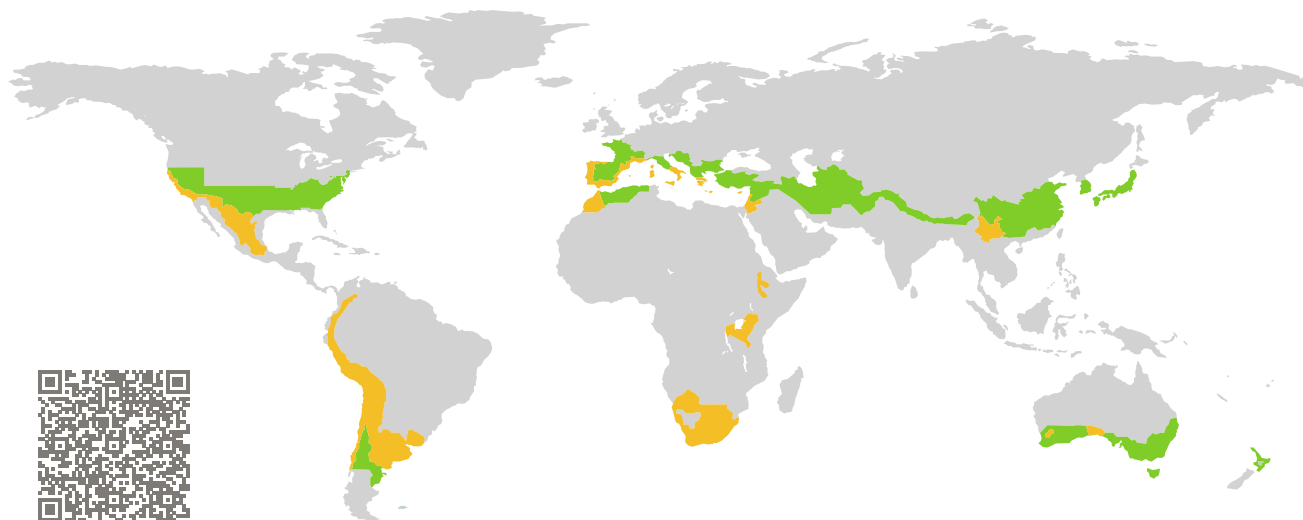

Category: **Window Frame**
Manufacturer: **Carpinteria Llodiana S.A.,
Llodio,
Spain**
Product name: **VENTACLIM SUPER-CONFORT**

**This certificate was awarded based on the following
criteria for the warm, temperate climate zone**

Comfort $U_W = 1.00 \leq 1.00 \text{ W}/(\text{m}^2 \text{ K})$
 $U_{W, \text{installed}} \leq 1.05 \text{ W}/(\text{m}^2 \text{ K})$
with $U_g = 0.90 \text{ W}/(\text{m}^2 \text{ K})$

Hygiene $f_{Rsi=0.25} \geq 0.65$

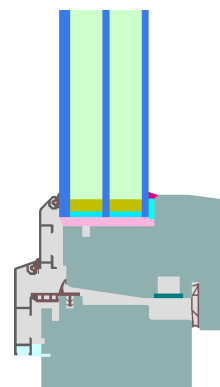

warm, temperate climate

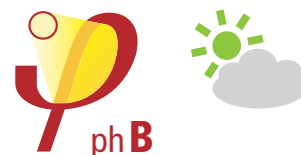

**CERTIFIED
COMPONENT**

Passive House Institute

Passive House
efficiency class

phE

phD

phC

phB

phA

www.passivehouse.com

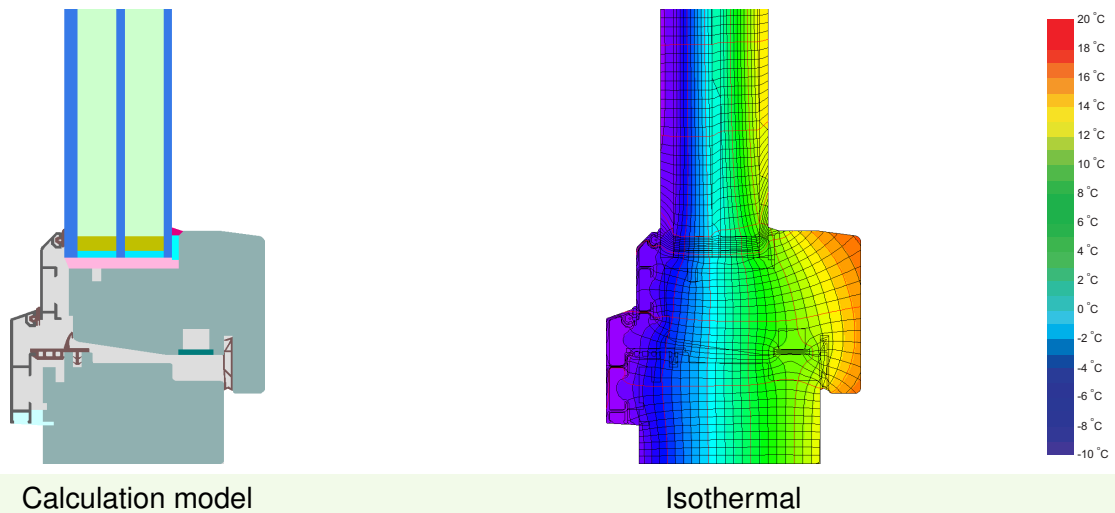

Calculation model Isothermal

Description

Timber frame (0,11 W/(mK)) with aluminum cladding. Pane thickness: 50 mm (4/18/4/18/6), rebate depth: 11 mm, spacer: Chromatech Ultra F with polyurethane as secondary seal.

Explanation

The window U-values were calculated for the test window size of 1.23 m × 1.48 m with $U_g = 0.90$ W/(m² K). If a higher quality glazing is used, the window U-values will improve as follows:

Glazing	$U_g =$	0.90	0.70	0.63	0.55	W/(m ² K)
		↓	↓	↓	↓	
Window	$U_W =$	1.00	0.86	0.81	0.75	W/(m ² K)





Transparent building components are classified into efficiency classes depending on the heat losses through the opaque part. The frame U-Values, frame widths, thermal bridges at the glazing edge, and the glazing edge lengths are included in these heat losses. A more detailed report of the calculations performed in the context of certification is available from the manufacturer.

The Passive House Institute has defined international component criteria for seven climate zones. In principle, components which have been certified for climate zones with higher requirements may also be used in climates with less stringent requirements. In a particular climate zone it may make sense to use a component of a higher thermal quality which has been certified for a climate zone with more stringent requirements.

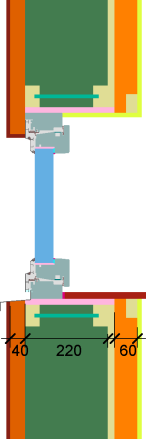
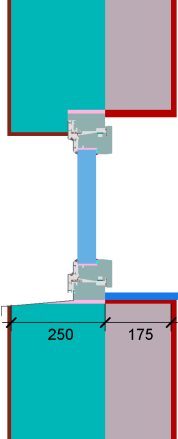
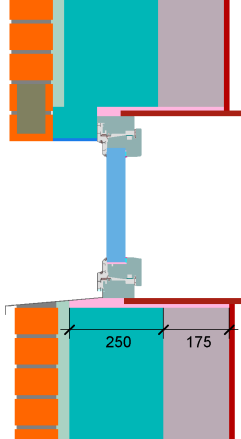
Further information relating to certification can be found on www.passivehouse.com and passipedia.org.

Validated installations

Lightweight timber (operable)		Exterior insulation and finishing system (EIFS) (operable)		Cavity wall (operable)	
$U_{\text{Wall}} = 0.15 \text{ W}/(\text{m}^2 \text{ K})$		$U_{\text{Wall}} = 0.13 \text{ W}/(\text{m}^2 \text{ K})$		$U_{\text{Wall}} = 0.13 \text{ W}/(\text{m}^2 \text{ K})$	
					
Ψ_{install}	W/(m K)	Ψ_{install}	W/(m K)	Ψ_{install}	W/(m K)
Top	0.016	Top	0.010	Top	0.009
Side	0.016	Side	0.010	Side	0.009
Bottom	0.022	Bottom	0.023	Bottom	0.018
$U_{W,\text{installed}} = 1.05 \text{ W}/(\text{m}^2 \text{ K})$		$U_{W,\text{installed}} = 1.04 \text{ W}/(\text{m}^2 \text{ K})$		$U_{W,\text{installed}} = 1.03 \text{ W}/(\text{m}^2 \text{ K})$	

Frame values		Frame width b_f mm	U -value frame U_f W/(m ² K)	Ψ -glazing edge Ψ_g W/(m K)	Temp. Factor $f_{Rsi=0.25}$ [-]
Flying Mullion (FM1)		156	0.95	0.029	0.66
Bottom (OB1)		108	1.01	0.029	0.66
Top (OH1)		108	0.98	0.029	0.66
Lateral (OJ1)		108	0.98	0.029	0.66
Spacer: CHROMATECH ultra F		Secondary seal: Polyurethan			

