

CERTIFICATE

Certified Passive House Component

Component-ID 0637wi03 valid until 31st December 2025

Passive House Institute
Dr. Wolfgang Feist
64283 Darmstadt
Germany

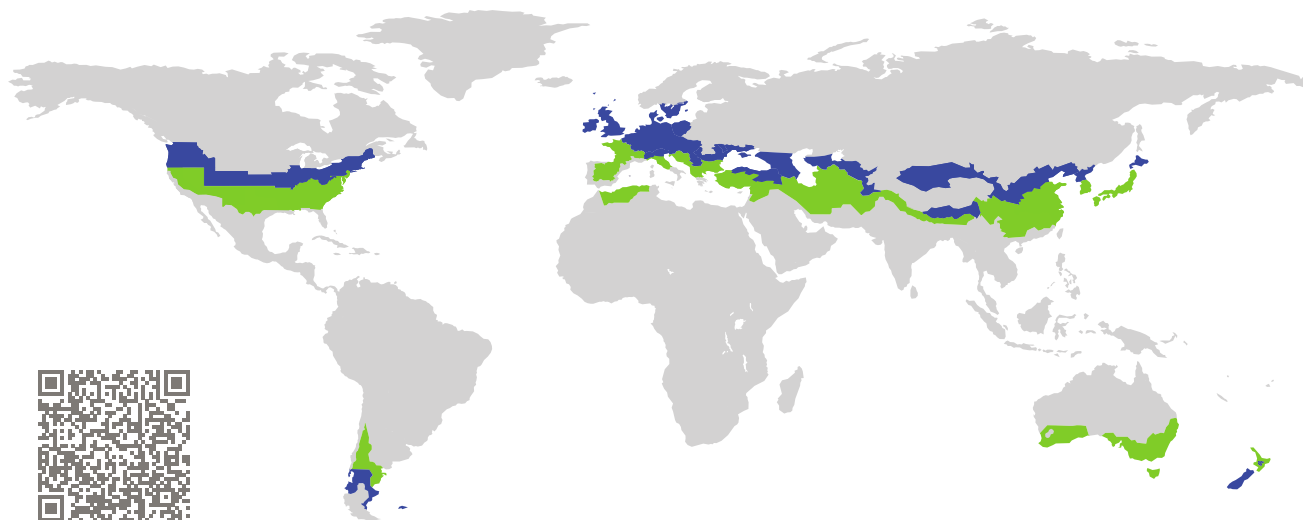

Category: **Window Frame**
Manufacturer: **Pfeffer Fenster,
Starzach,
Germany**
Product name: **Pfeffer RPS**

**This certificate was awarded based on the following
criteria for the cool, temperate climate zone**

Comfort $U_W = 0.79 \leq 0.80 \text{ W}/(\text{m}^2 \text{ K})$
 $U_{W,\text{installed}} \leq 0.85 \text{ W}/(\text{m}^2 \text{ K})$
with $U_g = 0.70 \text{ W}/(\text{m}^2 \text{ K})$

Hygiene $f_{Rsi=0.25} \geq 0.70$

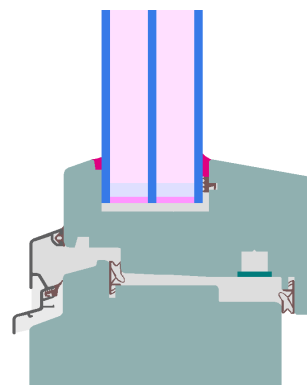

cool, temperate climate



**CERTIFIED
COMPONENT**

Passive House Institute

Passive House
efficiency class

phE

phD

phC

phB

phA

www.passivehouse.com

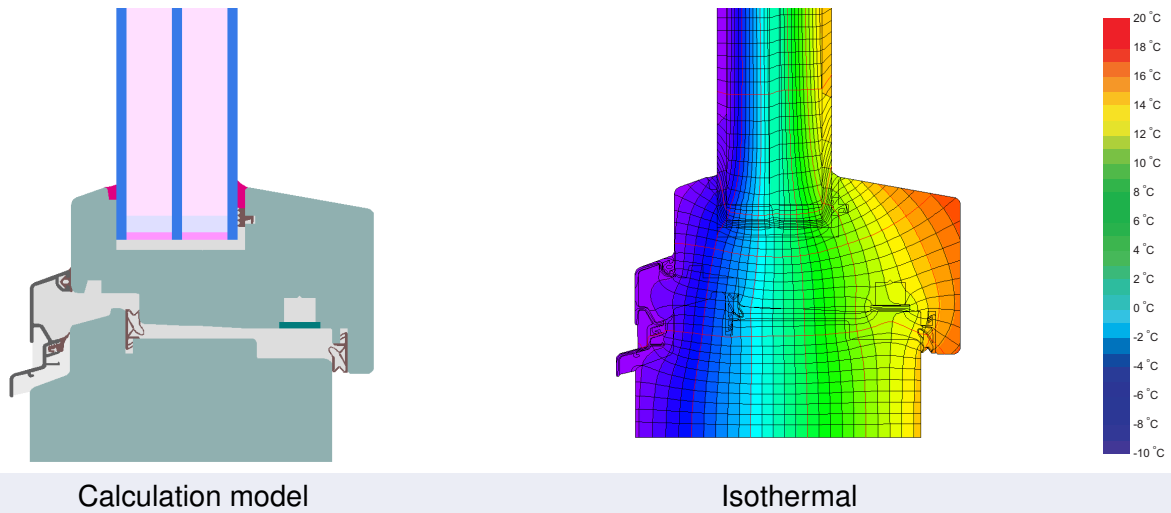

Description

Timber window frame (Spruce/Fir 0,11 W/(mK)). Because of the slim frame, good spacer (SWIS-SPACER Ultimate) and optimiced geometrie, this window achieves the standard without additional insulation. Pane thickness: 48 mm (4/18/4/18/4), Rebate depth: 20 mm.

Explanation

The window U-values were calculated for the test window size of 1.23 m × 1.48 m with $U_g = 0.70 \text{ W}/(\text{m}^2 \text{ K})$. If a higher quality glazing is used, the window U-values will improve as follows:

Glazing	$U_g =$	0.70	0.64	0.58	0.52	W/(m ² K)
		↓	↓	↓	↓	
Window	$U_W =$	0.79	0.75	0.71	0.66	W/(m ² K)





Transparent building components are classified into efficiency classes depending on the heat losses through the opaque part. The frame U-Values, frame widths, thermal bridges at the glazing edge, and the glazing edge lengths are included in these heat losses. A more detailed report of the calculations performed in the context of certification is available from the manufacturer.

The Passive House Institute has defined international component criteria for seven climate zones. In principle, components which have been certified for climate zones with higher requirements may also be used in climates with less stringent requirements. In a particular climate zone it may make sense to use a component of a higher thermal quality which has been certified for a climate zone with more stringent requirements.

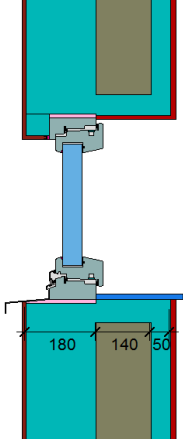
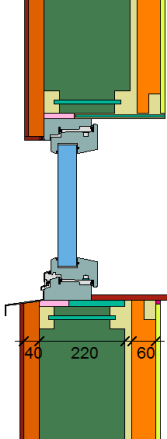
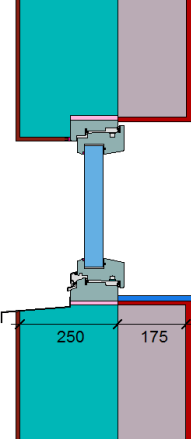
Further information relating to certification can be found on www.passivehouse.com and passipedia.org.

Validated installations

Formwork blocks (operable)		Lightweight timber (operable)		Exterior insulation and finishing system (EIFS) (operable)	
					
Ψ_{install}	W/(m K)	Ψ_{install}	W/(m K)	Ψ_{install}	W/(m K)
Top	0.003	Top	0.019	Top	0.002
Side	0.003	Side	0.019	Side	0.002
Bottom	0.011	Bottom	0.026	Bottom	0.016
$U_{W,\text{installed}} = 0.81 \text{ W}/(\text{m}^2 \text{ K})$		$U_{W,\text{installed}} = 0.86 \text{ W}/(\text{m}^2 \text{ K})$		$U_{W,\text{installed}} = 0.81 \text{ W}/(\text{m}^2 \text{ K})$	

Frame values			Frame width b_f mm	U -value frame U_f W/(m ² K)	Ψ -glazing edge Ψ_g W/(m K)	Temp. Factor $f_{Rsi=0.25}$ [-]
Mullion 2 casements	(2M1)		133	0.86	0.022	0.73
Bottom	(OB1)		109	0.87	0.022	0.73
Top	(OH1)		88	0.84	0.022	0.73
Lateral	(OJ1)		88	0.84	0.022	0.73
Spacer: SWISSPACER Ultimate			Secondary seal: Polysulfide			

