

CERTIFICATE

Certified Passive House Component

Component-ID 1080wi04 valid until 31st December 2021

Passive House Institute
Dr. Wolfgang Feist
64283 Darmstadt
Germany

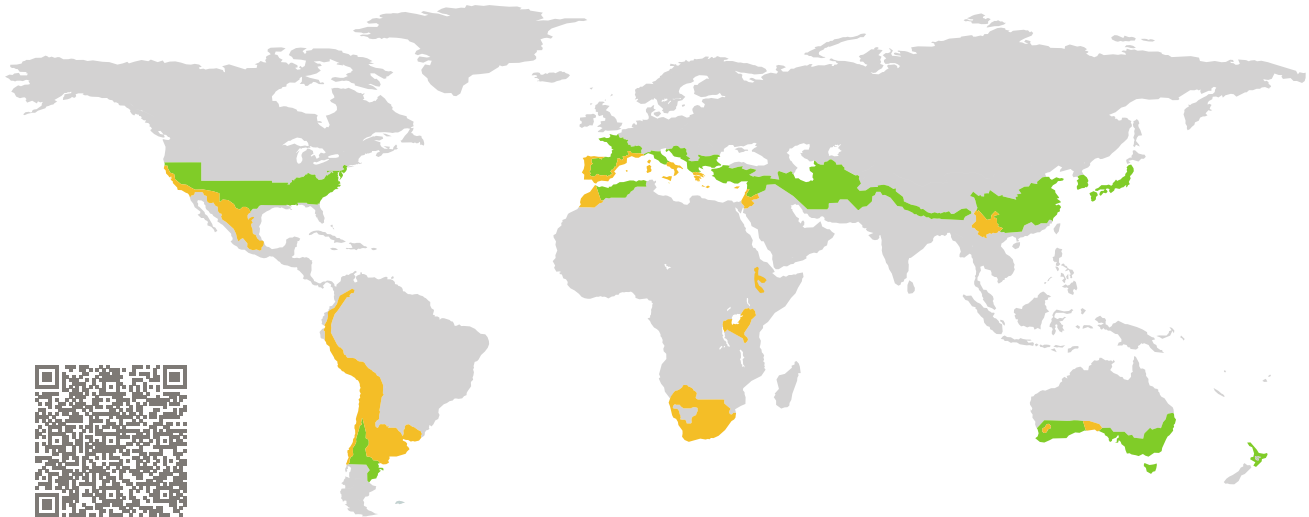

Category: **Window Frame**
Manufacturer: **CARMAVE SL,
Tarazona,
Spain**
Product name: **Carmave Mixta 120 Premium**

**This certificate was awarded based on the following
criteria for the warm, temperate climate zone**

Comfort $U_W = 1.00 \leq 1.00 \text{ W}/(\text{m}^2 \text{ K})$
 $U_{W,\text{installed}} \leq 1.05 \text{ W}/(\text{m}^2 \text{ K})$
with $U_g = 0.90 \text{ W}/(\text{m}^2 \text{ K})$

Hygiene $f_{Rsi=0.25} \geq 0.65$

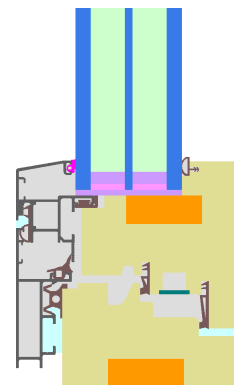

warm, temperate climate



ph C

**CERTIFIED
COMPONENT**

Passive House Institute

Passive House
efficiency class

phE

phD

phC

phB

phA

www.passivehouse.com

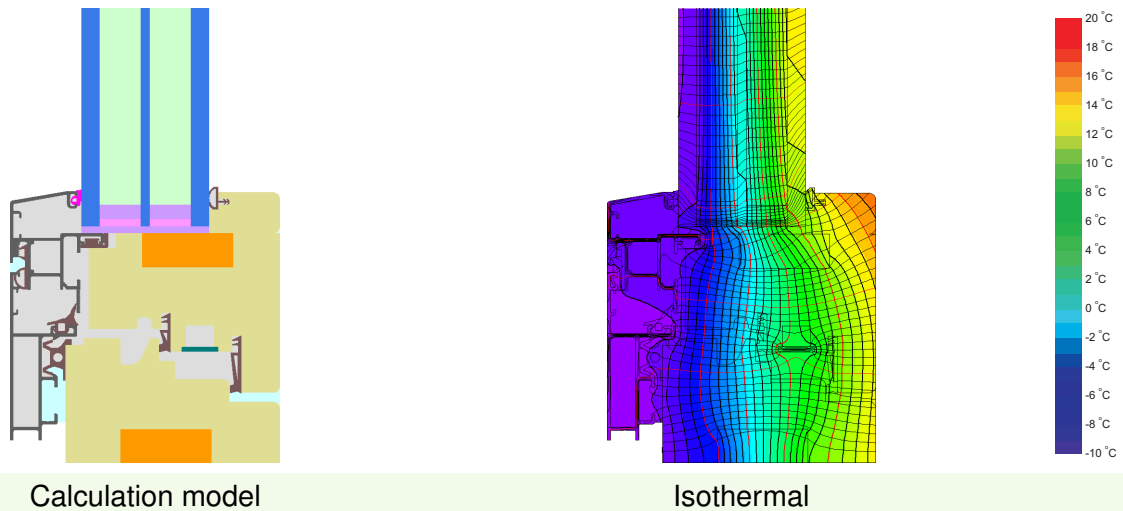

Description

Timberframe (0.13 W/(mK)) with aluminium-facing-shell and PU-insulation (0.028 W/(mK)) inside the sash and blindframe. Pane thickness: 56 mm (8/18/4/18/8), rebate depth: 15 mm, spacer: SWIS-SPACER Ultimate

Explanation





The window U-values were calculated for the test window size of 1.23 m × 1.48 m with $U_g = 0.90$ W/(m² K). If a higher quality glazing is used, the window U-values will improve as follows:

Glazing	$U_g =$	0.90	0.80	0.70	0.68	W/(m ² K)
		↓	↓	↓	↓	
Window	$U_W =$	1.00	0.93	0.86	0.85	W/(m ² K)

Transparent building components are classified into efficiency classes depending on the heat losses through the opaque part. The frame U-Values, frame widths, thermal bridges at the glazing edge, and the glazing edge lengths are included in these heat losses. A more detailed report of the calculations performed in the context of certification is available from the manufacturer.

The Passive House Institute has defined international component criteria for seven climate zones. In principle, components which have been certified for climate zones with higher requirements may also be used in climates with less stringent requirements. In a particular climate zone it may make sense to use a component of a higher thermal quality which has been certified for a climate zone with more stringent requirements.

Further information relating to certification can be found on www.passivehouse.com and passipedia.org.

Frame values		Frame width b_f mm	U -value frame U_f W/(m ² K)	Ψ -panel edge Ψ_g W/(m K)	Temp. Factor $f_{RSI=0.25}$ [-]
Top	(to) 	119	0.99	0.027	0.70
Side	(s) 	119	0.99	0.027	0.70
Bottom	(bo) 	119	0.99	0.027	0.70
Mullion flying	(fm) 	182	1.00	0.027	0.71
Spacer: SWISSPACER Ultimate			Secondary seal: Polysulfid		

Validated installations

