

CERTIFICATE

Certified Passive House Component

Component-ID 1251wi02 valid until 31st December 2025

Passive House Institute
Dr. Wolfgang Feist
64283 Darmstadt
Germany

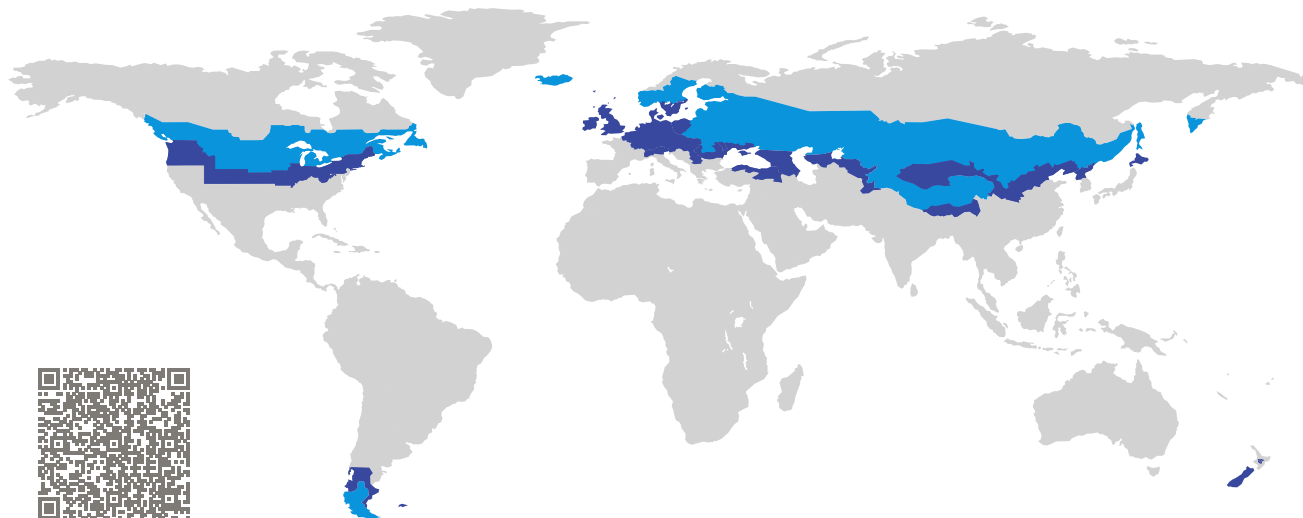

Category: **Window connection**
Manufacturer: **Shanghai G-ren New Material Science and Technology Co., Ltd, Shanghai, China**
Product name: **GR-PW-85 ultra**

This certificate was awarded based on the following criteria for the cold climate zone

Comfort $U_{W,installed} \leq 0.65 \text{ W}/(\text{m}^2 \text{ K})$
with $U_g = 0.52 \text{ W}/(\text{m}^2 \text{ K})$

Hygiene $f_{Rsi=0.25} \geq 0.75$

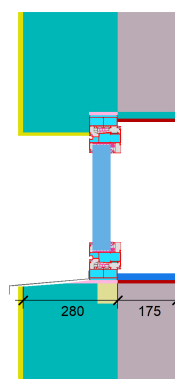

Passive House
efficiency class

phE

phD

phC

phB

phA

cold climate



phA

**CERTIFIED
COMPONENT**

Passive House Institute

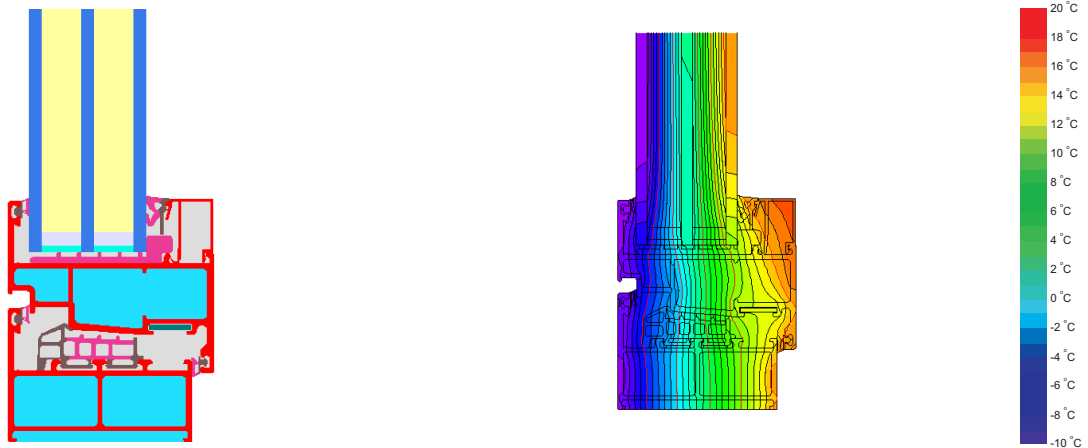

Calculation model

Isothermal

Description

GRPU-frame (0,27 W/(mK)), insulated by PU-foam (0,028 W/(mK)). Pane thickness: 54 mm (6/18/6/18/6), rebate depth: 25 mm, spacer: SWISSPACER Ultimate with butyl as secondary seal.

Explanation

The window U-values were calculated for the test window size of 1.23 m × 1.48 m with $U_g = 0.52 \text{ W}/(\text{m}^2 \text{ K})$. If a higher quality glazing is used, the window U-values will improve as follows:

Glazing	$U_g =$	0.52	0.70	0.58	0.35	W/(m ² K)
		↓	↓	↓	↓	
Window	$U_W =$	0.63	0.75	0.67	0.51	W/(m ² K)





Transparent building components are classified into efficiency classes depending on the heat losses through the opaque part. The frame U-Values, frame widths, thermal bridges at the glazing edge, and the glazing edge lengths are included in these heat losses. A more detailed report of the calculations performed in the context of certification is available from the manufacturer.

The Passive House Institute has defined international component criteria for seven climate zones. In principle, components which have been certified for climate zones with higher requirements may also be used in climates with less stringent requirements. In a particular climate zone it may make sense to use a component of a higher thermal quality which has been certified for a climate zone with more stringent requirements.

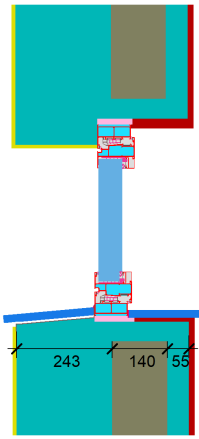
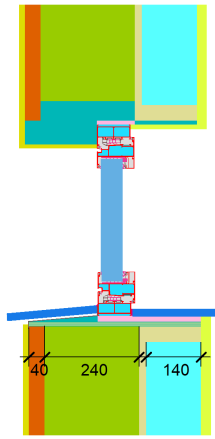
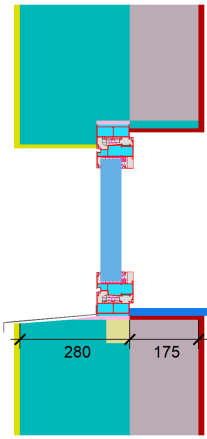
Further information relating to certification can be found on www.passivehouse.com and passipedia.org.

Validated installations

Formwork blocks (operable)	Lightweight timber (operable)	Exterior insulation and finishing system (EIFS) (operable)
$U_{\text{Wall}} = 0.11 \text{ W}/(\text{m}^2 \text{ K})$	$U_{\text{Wall}} = 0.10 \text{ W}/(\text{m}^2 \text{ K})$	$U_{\text{Wall}} = 0.12 \text{ W}/(\text{m}^2 \text{ K})$
		
Ψ_{install} W/(m K)	Ψ_{install} W/(m K)	Ψ_{install} W/(m K)
Top 0.001	Top 0.000	Top -0.001
Side 0.001	Side 0.000	Side -0.001
Bottom 0.020	Bottom 0.030	Bottom 0.033
$U_{W,\text{installed}} = 0.65 \text{ W}/(\text{m}^2 \text{ K})$	$U_{W,\text{installed}} = 0.65 \text{ W}/(\text{m}^2 \text{ K})$	$U_{W,\text{installed}} = 0.65 \text{ W}/(\text{m}^2 \text{ K})$

Frame values		Frame width b_f mm	U -value frame U_f W/(m ² K)	Ψ -glazing edge Ψ_g W/(m K)	Temp. Factor $f_{Rsi=0.25}$ [-]
Mullion 2 casements	(2M1) 	187	0.73	0.020	0.77
Bottom	(OB1) 	112	0.72	0.020	0.77
Top	(OH1) 	112	0.72	0.020	0.77
Lateral	(OJ1) 	112	0.72	0.020	0.77
Spacer: SWISSPACER Ultimate			Secondary seal: Butyl		

