

CERTIFICATE

Certified Passive House Component

Component-ID 1575wi03 valid until 31st December 2025

Passive House Institute
Dr. Wolfgang Feist
64283 Darmstadt
Germany

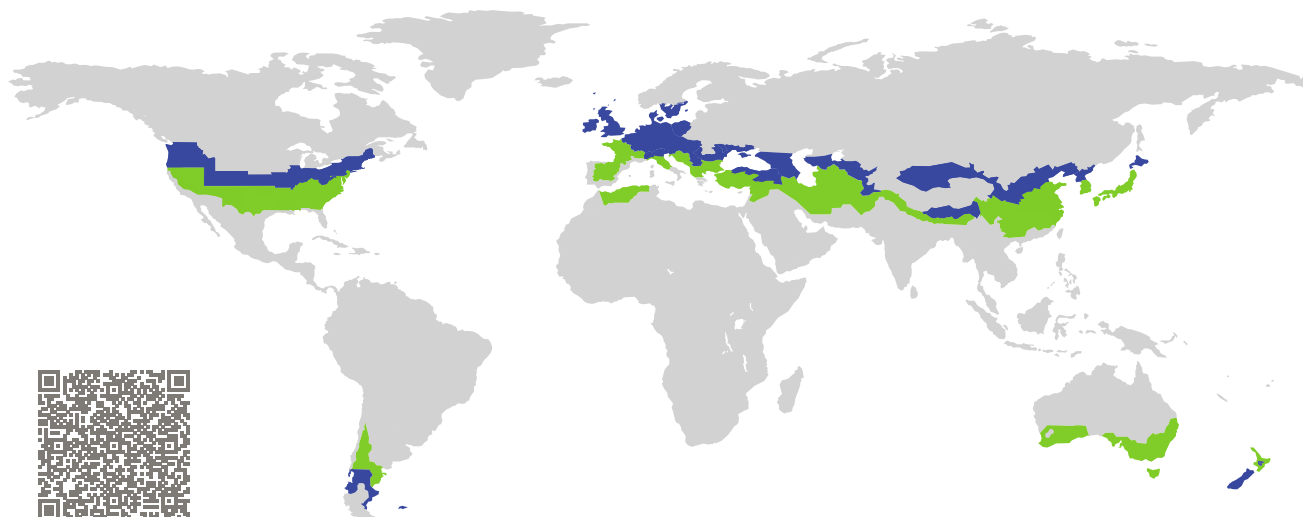

Category: **Window Frame**
Manufacturer: **Aldno Energy Saving Doors and Windows Co., Ltd., Weifang, China**
Product name: **Aldno - P88**

This certificate was awarded based on the following criteria for the cool, temperate climate zone

Comfort $U_{W=0.80} \leq 0.80 \text{ W}/(\text{m}^2 \text{ K})$
 $U_{W,\text{installed}} \leq 0.85 \text{ W}/(\text{m}^2 \text{ K})$
with $U_g = 0.70 \text{ W}/(\text{m}^2 \text{ K})$

Hygiene $f_{Rsi=0.25} \geq 0.70$

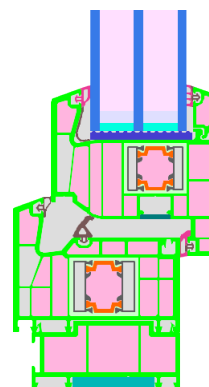

cool, temperate climate



CERTIFIED COMPONENT

Passive House Institute

Passive House efficiency class

phE

phD

phC

phB

phA

www.passivehouse.com

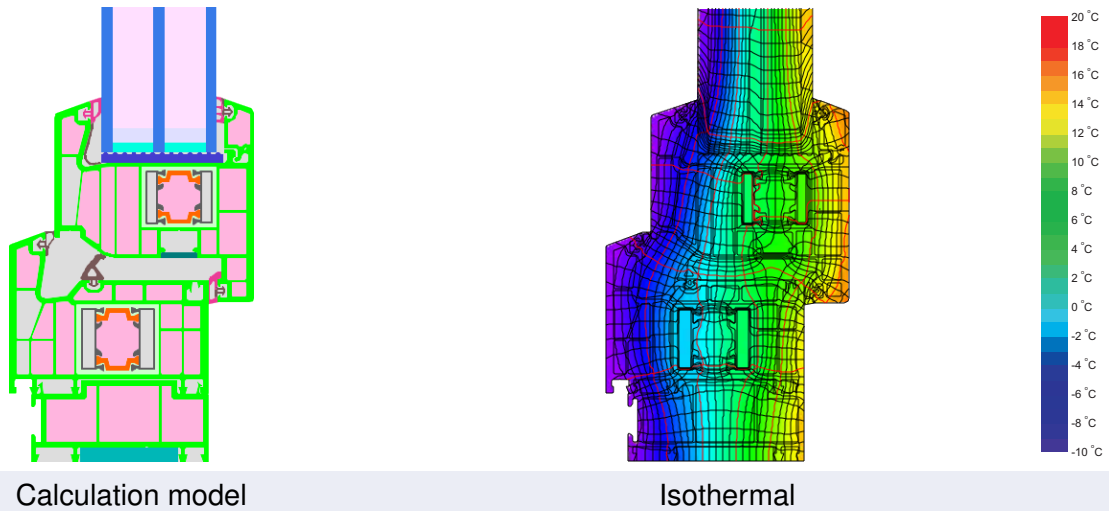

Description

PVC frame with PU foam (injected, 0,040 W/(mK)) insulated chambers. Reinforcement with aluminium profiles, thermally separated using polyamide (Technoform Low Lambda PA 66 GF 25, 0,21 W/(mK)) separators. Pane thickness 51 mm (5/18/5/18/5), rebate depth 24 mm. Spacer: SWISSPACER Ultimate with butyl secondary seal.

Explanation

The window U-values were calculated for the test window size of 1.23 m × 1.48 m with $U_g = 0.70$ W/(m² K). If a higher quality glazing is used, the window U-values will improve as follows:

Glazing	$U_g =$	0.70	0.64	0.58	0.52	W/(m ² K)
		↓	↓	↓	↓	
Window	$U_W =$	0.80	0.77	0.73	0.69	W/(m ² K)





Transparent building components are classified into efficiency classes depending on the heat losses through the opaque part. The frame U-Values, frame widths, thermal bridges at the glazing edge, and the glazing edge lengths are included in these heat losses. A more detailed report of the calculations performed in the context of certification is available from the manufacturer.

The Passive House Institute has defined international component criteria for seven climate zones. In principle, components which have been certified for climate zones with higher requirements may also be used in climates with less stringent requirements. In a particular climate zone it may make sense to use a component of a higher thermal quality which has been certified for a climate zone with more stringent requirements.

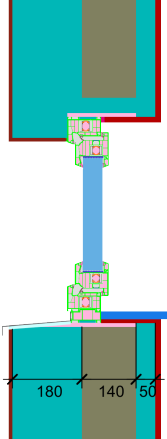
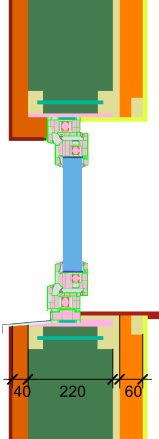
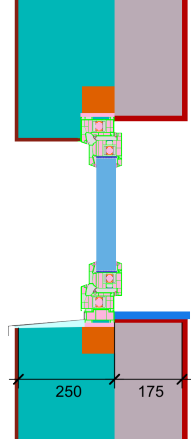
Further information relating to certification can be found on www.passivehouse.com and passipedia.org.

Validated installations

Formwork blocks (operable)	Lightweight timber (operable)	Exterior insulation and finishing system (EIFS) (operable)
$U_{Wall} = 0.15 \text{ W}/(\text{m}^2 \text{ K})$	$U_{Wall} = 0.13 \text{ W}/(\text{m}^2 \text{ K})$	$U_{Wall} = 0.13 \text{ W}/(\text{m}^2 \text{ K})$
		
$\Psi_{install}$ W/(m K)	$\Psi_{install}$ W/(m K)	$\Psi_{install}$ W/(m K)
Top 0.000	Top 0.007	Top 0.002
Side 0.000	Side 0.007	Side 0.002
Bottom 0.039	Bottom 0.014	Bottom 0.024
$U_{W,installed} = 0.83 \text{ W}/(\text{m}^2 \text{ K})$	$U_{W,installed} = 0.83 \text{ W}/(\text{m}^2 \text{ K})$	$U_{W,installed} = 0.82 \text{ W}/(\text{m}^2 \text{ K})$

Frame values		Frame width b_f mm	U -value frame U_f W/(m ² K)	Ψ -glazing edge Ψ_g W/(m K)	Temp. Factor $f_{Rsi=0.25}$ [-]
Flying Mullion (FM1)		214	0.83	0.022	0.73
Bottom (OB1)		159	0.84	0.022	0.74
Top (OH1)		131	0.84	0.022	0.74
Lateral (OJ1)		131	0.84	0.022	0.74
Spacer: SWISSPACER ULTIMATE		Secondary seal: Butyl			

