

# CERTIFICATE

Certified Passive House Component

Component-ID 2161wi03 valid until 31st December 2025

Passive House Institute  
Dr. Wolfgang Feist  
64283 Darmstadt  
Germany

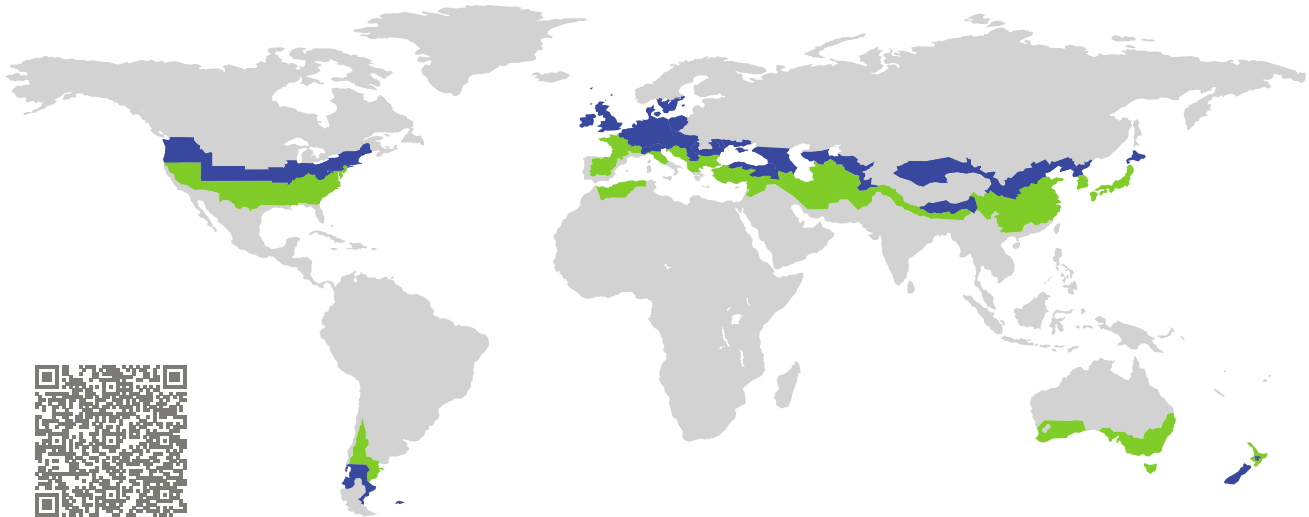

Category: **Window Frame**  
Manufacturer: **Weifang Yerui Industry and Trade Co., Ltd., Weifang, China**  
Product name: **YHS103**

**This certificate was awarded based on the following criteria for the cool, temperate climate zone**

Comfort  $U_W = 0.80 \leq 0.80 \text{ W}/(\text{m}^2 \text{ K})$   
 $U_{W, \text{installed}} \leq 0.85 \text{ W}/(\text{m}^2 \text{ K})$   
with  $U_g = 0.70 \text{ W}/(\text{m}^2 \text{ K})$

Hygiene  $f_{Rsi=0.25} \geq 0.70$

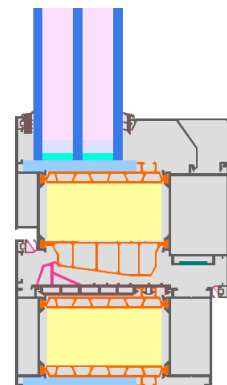

cool, temperate climate



**CERTIFIED COMPONENT**

Passive House Institute

Passive House  
efficiency class

phE

phD

phC

phB

phA

[www.passivehouse.com](http://www.passivehouse.com)

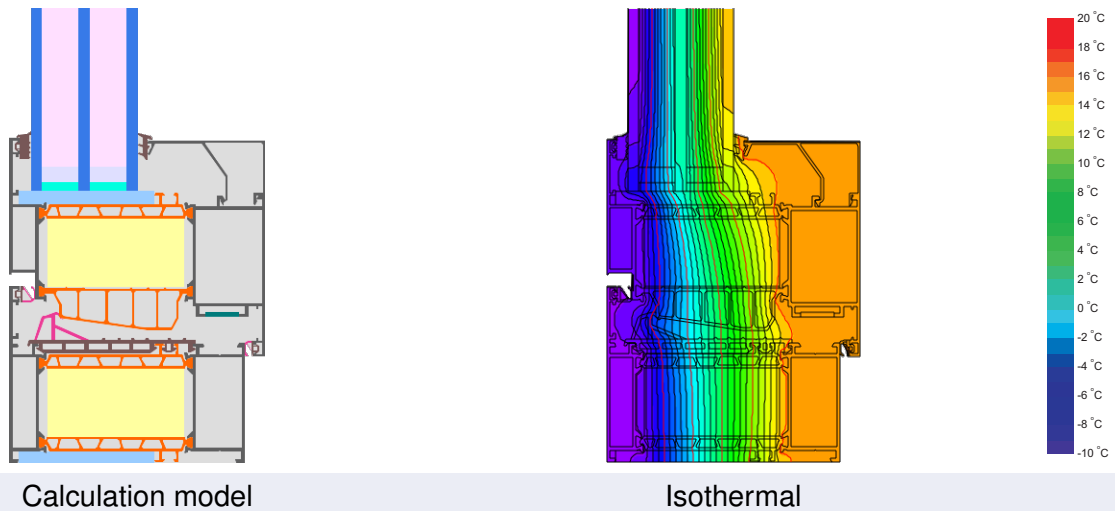

### Description

Aluminium frame with thermal separation (Technoform Low Lambda PA 0.21 W/(mK)) and insulation (Kooltherm 0.022 W/(mK)); Pane thickness: 47 mm (5/16/5/16/5), rebate depth: 23 mm. Spacer: Technoform SP16 with butyl secondary seal.

### Explanation

The window U-values were calculated for the test window size of 1.23 m × 1.48 m with  $U_g = 0.70$  W/(m<sup>2</sup> K). If a higher quality glazing is used, the window U-values will improve as follows:

Glazing	$U_g =$	0.70	0.64	0.58	0.52	W/(m <sup>2</sup> K)
		↓	↓	↓	↓	
Window	$U_w =$	0.80	0.77	0.73	0.69	W/(m <sup>2</sup> K)





Transparent building components are classified into efficiency classes depending on the heat losses through the opaque part. The frame U-Values, frame widths, thermal bridges at the glazing edge, and the glazing edge lengths are included in these heat losses. A more detailed report of the calculations performed in the context of certification is available from the manufacturer.

The Passive House Institute has defined international component criteria for seven climate zones. In principle, components which have been certified for climate zones with higher requirements may also be used in climates with less stringent requirements. In a particular climate zone it may make sense to use a component of a higher thermal quality which has been certified for a climate zone with more stringent requirements.

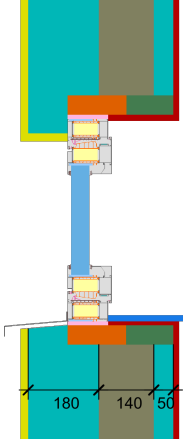
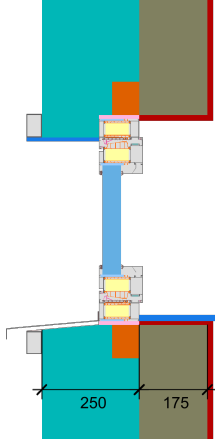
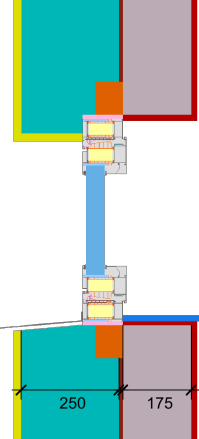
Further information relating to certification can be found on [www.passivehouse.com](http://www.passivehouse.com) and [passipedia.org](http://passipedia.org).

## Validated installations

Formwork blocks (operable)	Ventilated facade (operable)	Exterior insulation and finishing system (EIFS) (operable)
$U_{Wall} = 0.15 \text{ W}/(\text{m}^2 \text{ K})$	$U_{Wall} = 0.13 \text{ W}/(\text{m}^2 \text{ K})$	$U_{Wall} = 0.13 \text{ W}/(\text{m}^2 \text{ K})$
		
$\Psi_{install}$ W/(m K)	$\Psi_{install}$ W/(m K)	$\Psi_{install}$ W/(m K)
Top 0.014	Top 0.015	Top 0.016
Side 0.014	Side 0.015	Side 0.016
Bottom 0.019	Bottom 0.022	Bottom 0.022
$U_{W,installed} = 0.85 \text{ W}/(\text{m}^2 \text{ K})$	$U_{W,installed} = 0.85 \text{ W}/(\text{m}^2 \text{ K})$	$U_{W,installed} = 0.85 \text{ W}/(\text{m}^2 \text{ K})$

Frame values		Frame width $b_f$ mm	$U$ -value frame $U_f$ W/(m <sup>2</sup> K)	$\Psi$ -glazing edge $\Psi_g$ W/(m K)	Temp. Factor $f_{Rsi=0.25}$ [-]
Mullion 1 casement	(1M1) 	167	0.80	0.026	0.78
Bottom	(OB1) 	143	0.80	0.027	0.79
Top	(OH1) 	143	0.80	0.027	0.79
Lateral	(OJ1) 	143	0.80	0.027	0.79
Spacer: Technoform-Spacer SP16			Secondary seal: Butyl		

