

CERTIFICATE

Certified Passive House Component

Component-ID 1634wi03 valid until 31st December 2021

Passive House Institute
Dr. Wolfgang Feist
64283 Darmstadt
Germany

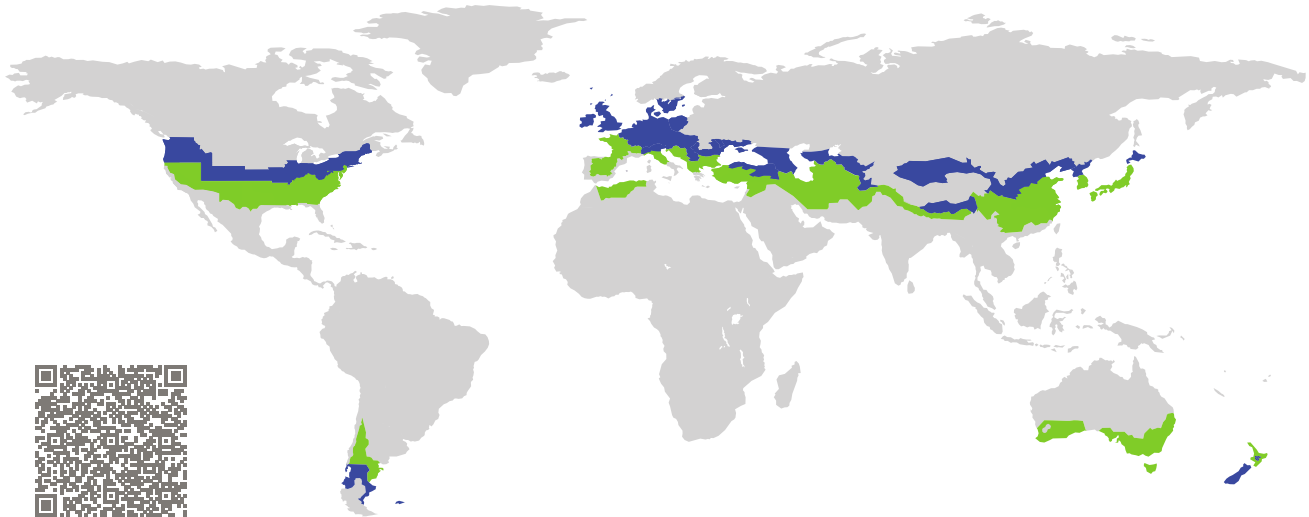

Category: **Window Frame**
Manufacturer: **Harbin Huaxing Energy-Saving Door and Window Co., Ltd., Harbin Heilongjiang, China**
Product name: **HS118FP**

This certificate was awarded based on the following criteria for the cool, temperate climate zone

Comfort $U_W = 0.75 \leq 0.80 \text{ W}/(\text{m}^2 \text{ K})$
 $U_{W,\text{installed}} \leq 0.85 \text{ W}/(\text{m}^2 \text{ K})$
with $U_g = 0.70 \text{ W}/(\text{m}^2 \text{ K})$

Hygiene $f_{Rsi=0.25} \geq 0.70$

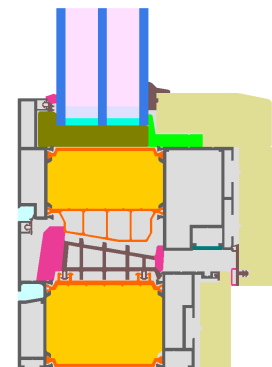

Passive House
efficiency class

phE

phD

phC

phB

phA

cool, temperate climate



**CERTIFIED
COMPONENT**

Passive House Institute

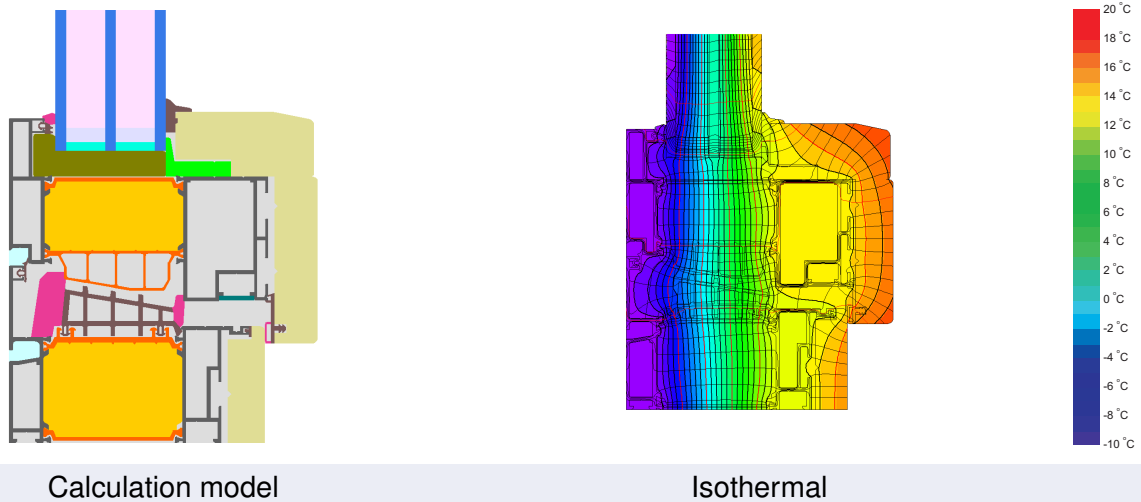

Calculation model Isothermal

Description

Aluminium frame with serral theparation (low lambda PA 0.21 W/(mK)) and insulation (PU foam 0.033 W/(mK) and PE foam 0.038 W/(mK)) and internal timber shell. Pane thickness: 51 mm (5/18/5/18/5), rebate depth: 15 mm. Spacer: TGI-Spacer Precision with butyl as secondary seal.

Explanation





The window U-values were calculated for the test window size of 1.23 m × 1.48 m with $U_g = 0.70 \text{ W}/(\text{m}^2 \text{ K})$. If a higher quality glazing is used, the window U-values will improve as follows:

Glazing	$U_g =$	0.70	0.64	0.58	0.54	W/(m ² K)
		↓	↓	↓	↓	
Window	$U_W =$	0.75	0.72	0.68	0.66	W/(m ² K)

Transparent building components are classified into efficiency classes depending on the heat losses through the opaque part. The frame U-Values, frame widths, thermal bridges at the glazing edge, and the glazing edge lengths are included in these heat losses. A more detailed report of the calculations performed in the context of certification is available from the manufacturer.

The Passive House Institute has defined international component criteria for seven climate zones. In principle, components which have been certified for climate zones with higher requirements may also be used in climates with less stringent requirements. In a particular climate zone it may make sense to use a component of a higher thermal quality which has been certified for a climate zone with more stringent requirements.

Further information relating to certification can be found on www.passivehouse.com and passipedia.org.

Frame values			Frame width b_f mm	U -value frame U_f W/(m ² K)	Ψ -panel edge Ψ_g W/(m K)	Temp. Factor $f_{RSI=0.25}$ [-]
Top	(to)		150	0.71	0.022	0.77
Side	(s)		150	0.71	0.022	0.77
Bottom	(bo)		150	0.71	0.022	0.77
Mullion 1 casement	(m1)		160	0.75	0.023	0.75
Spacer: TGI-Spacer Precision				Secondary seal: Butyl		

Validated installations

Formwork blocks (operable)

$U_{Wall} = 0.15 \text{ W/(m}^2 \text{ K)}$

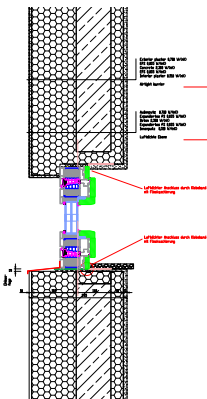

$\Psi_{install}$	W/(m K)
Top	0.012
Side	0.012
Bottom	0.019

$U_{W,installed} = 0.80 \text{ W/(m}^2 \text{ K)}$

Lightweight timber (operable)

$U_{Wall} = 0.13 \text{ W/(m}^2 \text{ K)}$

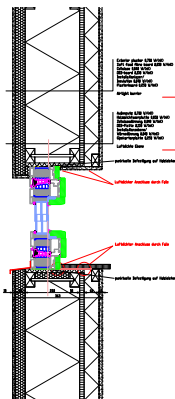

$\Psi_{install}$	W/(m K)
Top	0.017
Side	0.017
Bottom	0.019

$U_{W,installed} = 0.81 \text{ W/(m}^2 \text{ K)}$

Exterior insulation and finishing system (EIFS) (operable)

$U_{Wall} = 0.13 \text{ W/(m}^2 \text{ K)}$

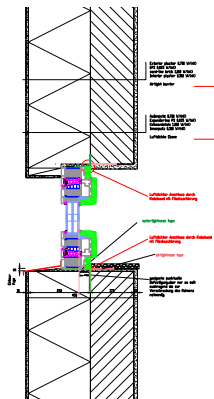

$\Psi_{install}$	W/(m K)
Top	0.012
Side	0.012
Bottom	0.015

$U_{W,installed} = 0.79 \text{ W/(m}^2 \text{ K)}$

