

CERTIFICATE

Certified Passive House Component

Component-ID 2239wi03 valid until 31st December 2025

Passive House Institute
Dr. Wolfgang Feist
64283 Darmstadt
Germany

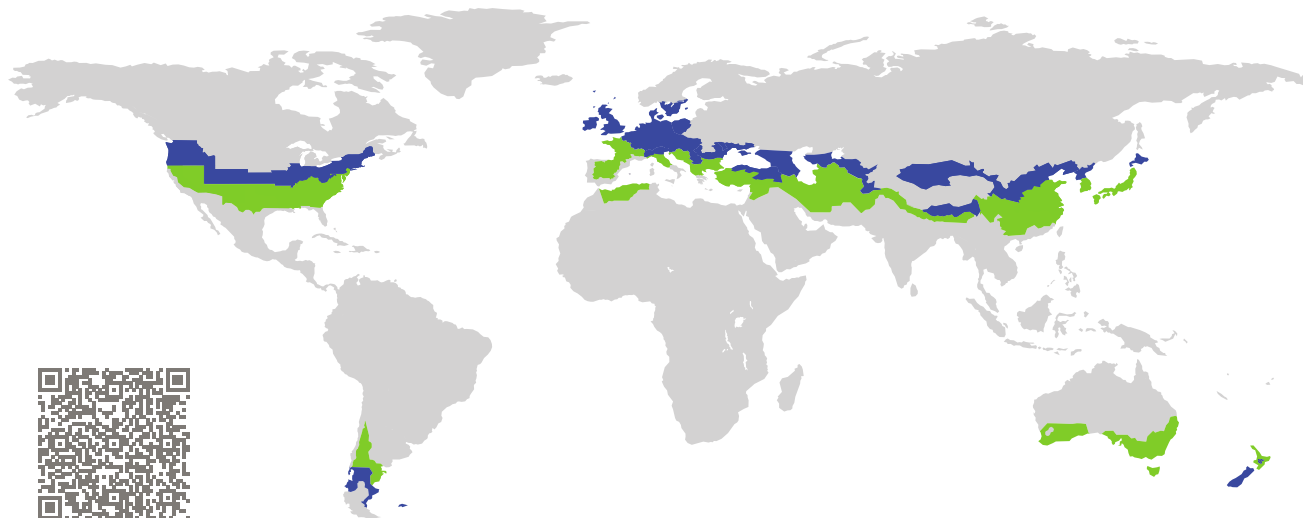

Category: **Window Frame**
Manufacturer: **Hebei Penjoy Windows Doors Co.,Ltd, Baoding, China**
Product name: **Passiv 130 wood**

This certificate was awarded based on the following criteria for the cool, temperate climate zone

Comfort $U_W = 0.79 \leq 0.80 \text{ W}/(\text{m}^2 \text{ K})$
 $U_{W,\text{installed}} \leq 0.85 \text{ W}/(\text{m}^2 \text{ K})$
with $U_g = 0.70 \text{ W}/(\text{m}^2 \text{ K})$

Hygiene $f_{Rsi=0.25} \geq 0.70$

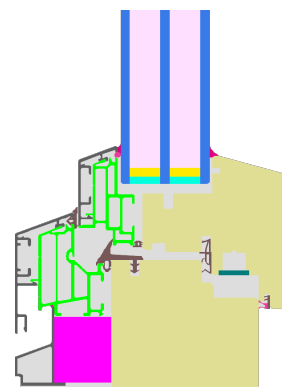

Passive House
efficiency class

phE

phD

phC

phB

phA

www.passivehouse.com

cool, temperate climate



**CERTIFIED
COMPONENT**

Passive House Institute

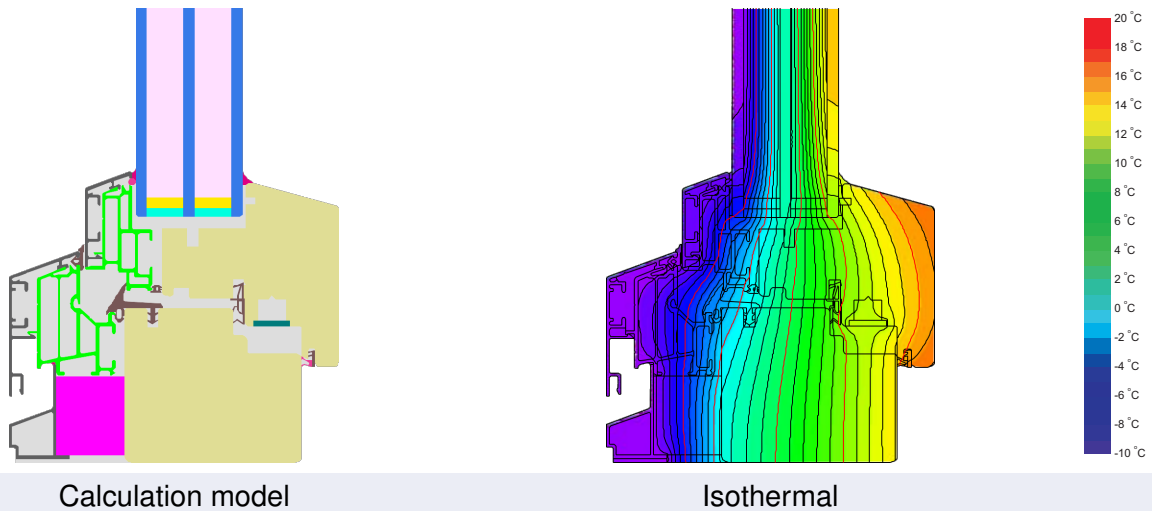

Description

Timber frame with insulation (EPS high density 0.045 W/(mK)) and external shell made of aluminium and PVC; Spacer: SuperSpacer Premium with Butyl as secondary seal. Pane thickness: 47 mm (5/16/5/16/5), rebate depth: 20 mm.

Explanation

The window U-values were calculated for the test window size of 1.23 m × 1.48 m with $U_g = 0.70 \text{ W}/(\text{m}^2 \text{ K})$. If a higher quality glazing is used, the window U-values will improve as follows:

Glazing	$U_g =$	0.70	0.64	0.58	0.54	$\text{W}/(\text{m}^2 \text{ K})$
		↓	↓	↓	↓	
Window	$U_w =$	0.79	0.75	0.71	0.69	$\text{W}/(\text{m}^2 \text{ K})$





Transparent building components are classified into efficiency classes depending on the heat losses through the opaque part. The frame U-Values, frame widths, thermal bridges at the glazing edge, and the glazing edge lengths are included in these heat losses. A more detailed report of the calculations performed in the context of certification is available from the manufacturer.

The Passive House Institute has defined international component criteria for seven climate zones. In principle, components which have been certified for climate zones with higher requirements may also be used in climates with less stringent requirements. In a particular climate zone it may make sense to use a component of a higher thermal quality which has been certified for a climate zone with more stringent requirements.

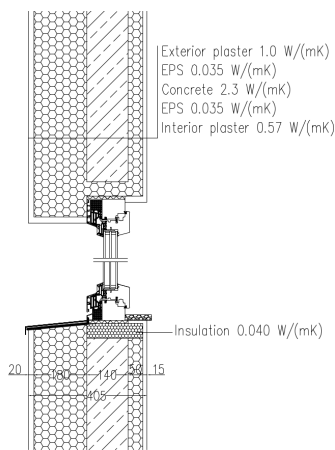
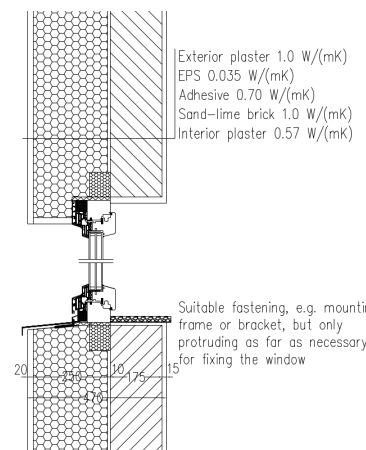
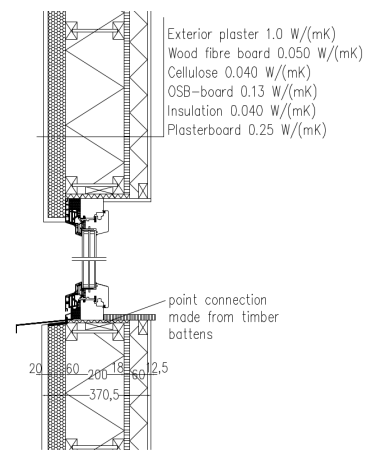
Further information relating to certification can be found on www.passivehouse.com and passipedia.org.

Validated installations

formwork blocks		Exterior insulation and finishing system		lightweight timber	
$U_{Wall} = 0.15 \text{ W}/(\text{m}^2 \text{ K})$		$U_{Wall} = 0.15 \text{ W}/(\text{m}^2 \text{ K})$		$U_{Wall} = 0.13 \text{ W}/(\text{m}^2 \text{ K})$	
 <p>Exterior plaster 1.0 W/(mK) EPS 0.035 W/(mK) Concrete 2.3 W/(mK) EPS 0.035 W/(mK) Interior plaster 0.57 W/(mK)</p> <p>Insulation 0.040 W/(mK)</p>		 <p>Exterior plaster 1.0 W/(mK) EPS 0.035 W/(mK) Adhesive 0.70 W/(mK) Sand-lime brick 1.0 W/(mK) Interior plaster 0.57 W/(mK)</p> <p>Suitable fastening, e.g. mounting frame or bracket, but only protruding as far as necessary for fixing the window</p>		 <p>Exterior plaster 1.0 W/(mK) Wood fibre board 0.050 W/(mK) Cellulose 0.040 W/(mK) OSB-board 0.13 W/(mK) Insulation 0.040 W/(mK) Plasterboard 0.25 W/(mK)</p> <p>point connection made from timber battens</p>	
$\Psi_{install}$	W/(m K)	$\Psi_{install}$	W/(m K)	$\Psi_{install}$	W/(m K)
Top	0.005	Top	0.003	Top	0.013
Side	0.005	Side	0.003	Side	0.013
Bottom	0.014	Bottom	0.015	Bottom	0.020
$U_{W,installed} = 0.81 \text{ W}/(\text{m}^2 \text{ K})$		$U_{W,installed} = 0.81 \text{ W}/(\text{m}^2 \text{ K})$		$U_{W,installed} = 0.83 \text{ W}/(\text{m}^2 \text{ K})$	

Frame values		Frame width b_f mm	U -value frame U_f W/(m ² K)	Ψ -glazing edge Ψ_g W/(m K)	Temp. Factor $f_{Rsi=0.25}$ [-]
Mullion 2 casements	(2M1) 	190	0.84	0.023	0.74
Bottom	(OB1) 	128	0.82	0.023	0.74
Top	(OH1) 	128	0.79	0.024	0.74
Lateral	(OJ1) 	128	0.79	0.024	0.74
Spacer: Super Spacer Premium			Secondary seal: Butyl		

