

# CERTIFICATE

Certified Passive House Component

Component-ID 1257ed03 valid until 31st December 2025

Passive House Institute  
Dr. Wolfgang Feist  
64283 Darmstadt  
Germany

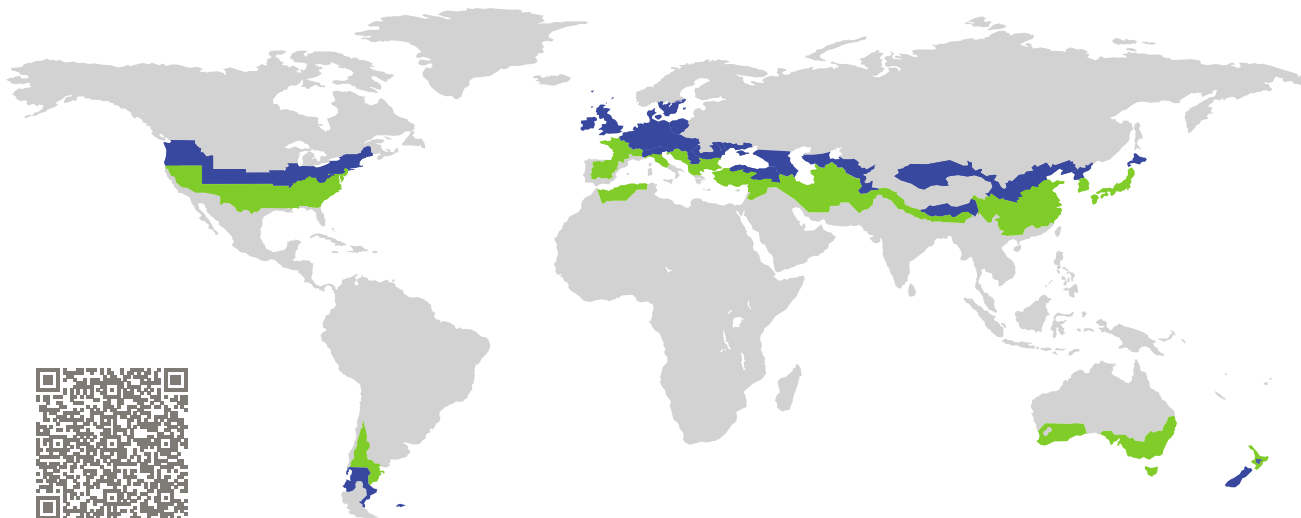

Category: **Entry door**  
Manufacturer: **Cascadia Windows & Doors**  
**Langley, BC**  
**Canada**  
Product name: **Cascadia Door PH**

**This certificate was awarded based on the following criteria for the cool, temperate climate zone**

Comfort  $U_D = 0.78 \leq 0.80 \text{ W}/(\text{m}^2 \text{ K})$   
 $U_{D,\text{installed}} \leq 0.85 \text{ W}/(\text{m}^2 \text{ K})$   
with  $U_g^1 = 0.70 \text{ W}/(\text{m}^2 \text{ K})$

Hygiene  $f_{Rsi=0.25} \geq 0.70$

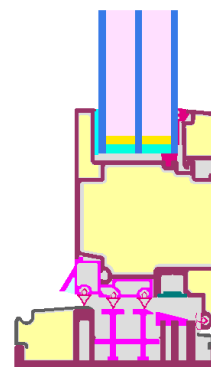

(Inward opening)

<sup>1</sup>Fully glazed door



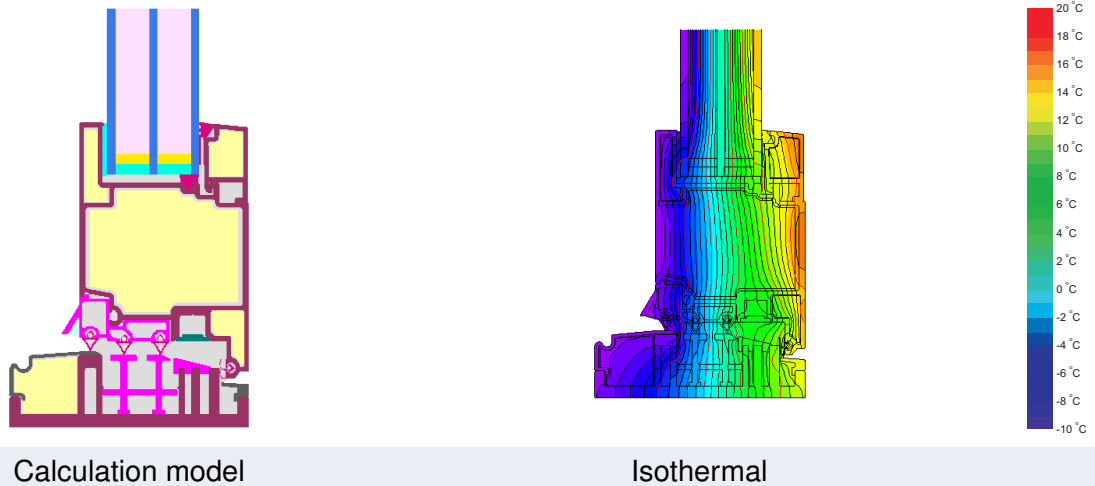

Calculation model Isothermal

### Description

Fiberglass frame, insulated by Resolic foam (0.023 W/(mK)).

### Explanation



The U-values of the door apply to a door 1.10 m wide by 2.20 m tall.

A detailed report of the calculations performed in the context of certification is available from the manufacturer.

Unless stated otherwise, the air tightness was determined according to EN 1026 with respect to the joint length under climate load in conjunction with EN 1121 for the closed, non-locked door. The result corresponds at least to air-tightness class 3 according to EN 12207.

The Passive House Institute has defined international component criteria for seven climate zones. In principle, components which have been certified for climate zones with higher requirements may also be used in climates with less stringent requirements. In a particular climate zone it may make sense to use a component of a higher thermal quality which has been certified for a climate zone with more stringent requirements.

Further information relating to certification can be found on [www.passivehouse.com](http://www.passivehouse.com) and [passipedia.org](http://passipedia.org).

Frame values		Frame width $b_f$ mm	$U$ -value frame $U_f$ W/(m <sup>2</sup> K)	$\Psi$ edge $\Psi_g$ W/(m K)	Temp. Factor $f_{Rsi=0.25}$ [-]
Door hinge side	(DJ1) 	132	0.79	0.022	0.75
Door lock side	(DL1) 	132	0.79	0.022	0.75
Top	(OH1) 	132	0.79	0.022	0.75
Threshold	(OT2) 	146	0.87	0.022	0.71
Spacer: Super Spacer Premium			Secondary seal: Butyl		

 Door hinge side

$b_f = 132 \text{ mm}$   
 $U_f = 0.79 \text{ W/(m}^2 \text{ K)}$   
 $\Psi_g = 0.022 \text{ W/(m K)}$   
 $f_{Rsi} = 0.75$



 Door lock side

$b_f = 132 \text{ mm}$   
 $U_f = 0.79 \text{ W/(m}^2 \text{ K)}$   
 $\Psi_g = 0.022 \text{ W/(m K)}$   
 $f_{Rsi} = 0.75$



 Top

$b_f = 132 \text{ mm}$   
 $U_f = 0.79 \text{ W/(m}^2 \text{ K)}$   
 $\Psi_g = 0.022 \text{ W/(m K)}$   
 $f_{Rsi} = 0.75$



 Threshold

$b_f = 146 \text{ mm}$   
 $U_f = 0.87 \text{ W/(m}^2 \text{ K)}$   
 $\Psi_g = 0.022 \text{ W/(m K)}$   
 $f_{Rsi} = 0.71$





## Validated installations

Formwork blocks top (operable)

$$U_1 = 0.15 \text{ [W/(m}^2 \text{ K)]}$$

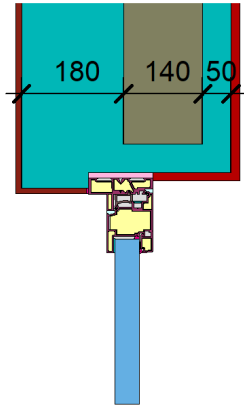

$$\Psi_{\text{install}} = 0.02 \text{ W/(m K)}$$

Formwork blocks side (operable)

$$U_1 = 0.15 \text{ [W/(m}^2 \text{ K)]}$$

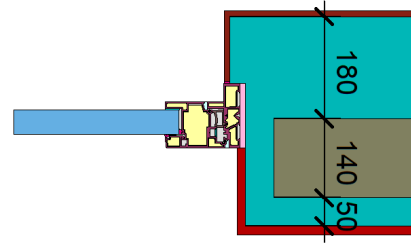

$$\Psi_{\text{install}} = 0.02 \text{ W/(m K)}$$

Lightweight timber top (operable)

$$U_1 = 0.13 \text{ [W/(m}^2 \text{ K)]}$$

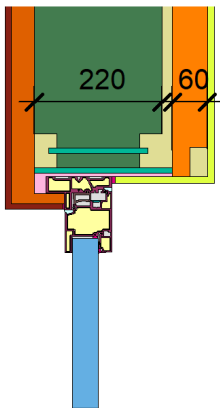

$$\Psi_{\text{install}} = 0.02 \text{ W/(m K)}$$

Lightweight timber side (operable)

$$U_1 = 0.13 \text{ [W/(m}^2 \text{ K)]}$$

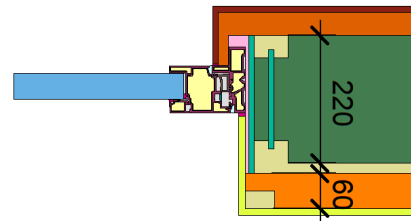

$$\Psi_{\text{install}} = 0.02 \text{ W/(m K)}$$

Exterior insulation and finishing s (EIFS)  
top (operable)

$$U_1 = 0.13 \text{ [W/(m}^2 \text{ K)]}$$

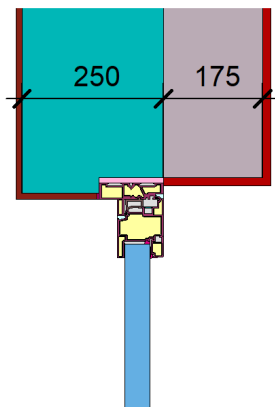

$$\Psi_{\text{install}} = 0.02 \text{ W/(m K)}$$

Ext insulation a. finish. s. (EIFS)  
threshold ceiling (operable)

$$U_1 = 0.13 \text{ [W/(m}^2 \text{ K)]}$$

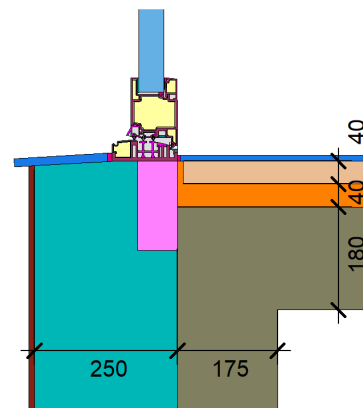

$$\Psi_{\text{install}} = 0.03 \text{ W/(m K)}$$

$$U_1 = 0.13 \text{ [W/(m}^2 \text{ K)]}$$

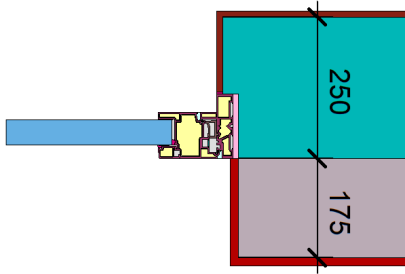

$$\Psi_{\text{install}} = 0.02 \text{ W/(m K)}$$

