

CERTIFICATE

Certified Passive House Component

Component-ID 1338wi04 valid until 31st December 2025

Passive House Institute
Dr. Wolfgang Feist
64283 Darmstadt
Germany

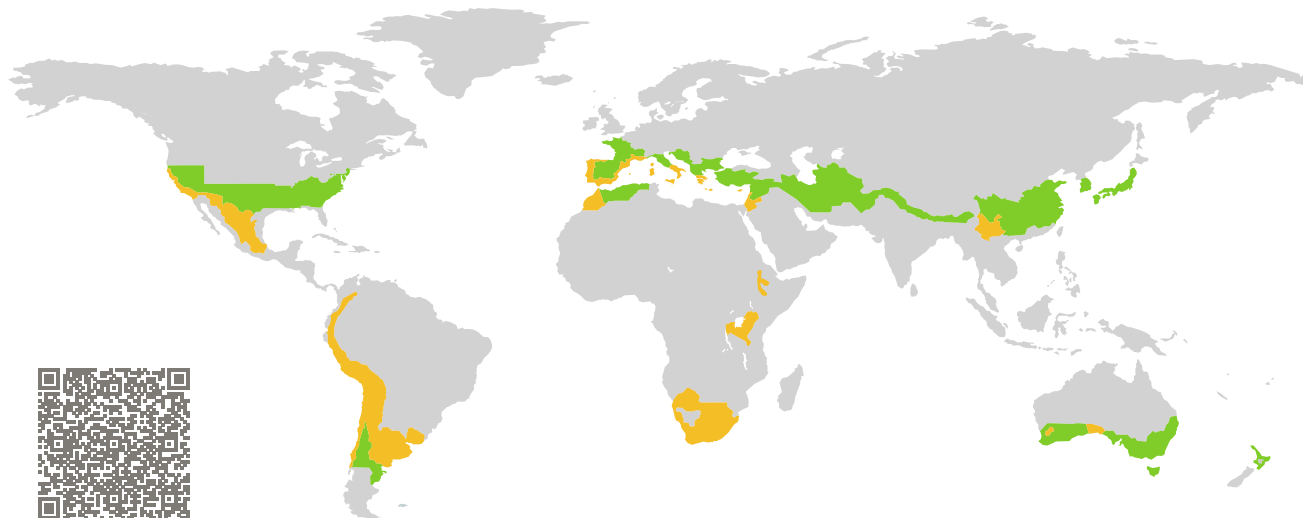

Category: **Window Frame**
Manufacturer: **Pisetta Romano di Pisetta Diego e Marco snc, Albiano (TN), Italy**
Product name: **IDEA 85**

This certificate was awarded based on the following criteria for the warm, temperate climate zone

Comfort $U_W = 0.97 \leq 1.00 \text{ W}/(\text{m}^2 \text{ K})$
 $U_{W,\text{installed}} \leq 1.05 \text{ W}/(\text{m}^2 \text{ K})$
with $U_g = 0.90 \text{ W}/(\text{m}^2 \text{ K})$

Hygiene $f_{Rsi=0.25} \geq 0.65$

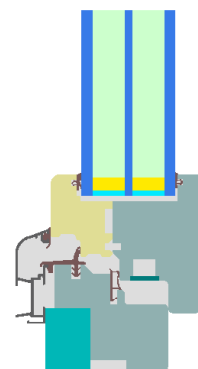

warm, temperate climate

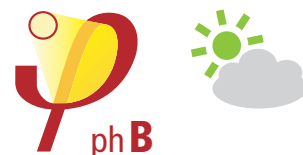

CERTIFIED COMPONENT

Passive House Institute

Passive House efficiency class

phE

phD

phC

phB

phA

www.passivehouse.com

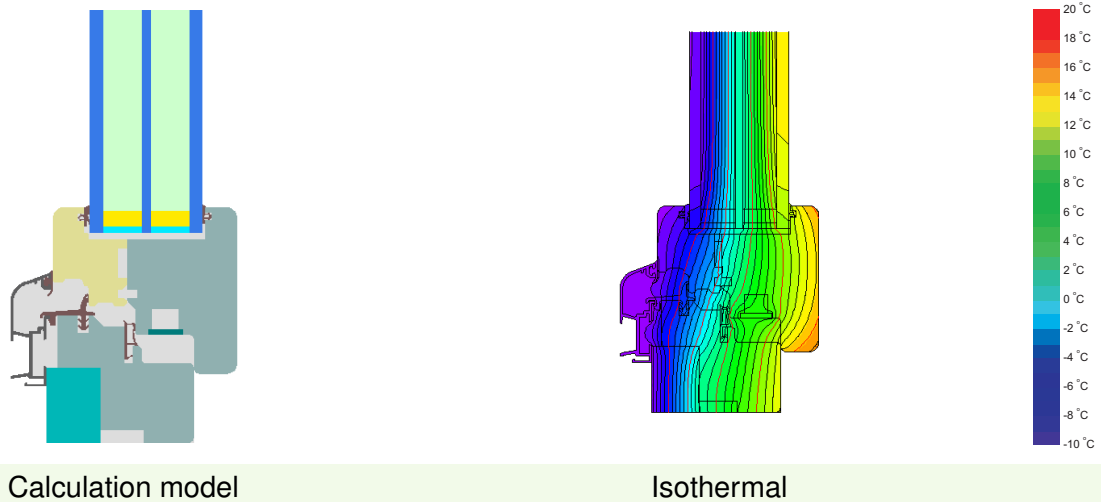

Calculation model Isothermal

Description

Timber frame (Fir 0,11 W/mK, Xps 0,035 W/mK, okumè 0,13 W/mK). Pane thickness: 52 mm (6/18/4/18/6), rebate depth: 18 mm. Spacer: SuperSpacer Tri-Seal with polyurethane as secondary seal.

Explanation

The window U-values were calculated for the test window size of 1.23 m × 1.48 m with $U_g = 0.90 \text{ W}/(\text{m}^2 \text{ K})$. If a higher quality glazing is used, the window U-values will improve as follows:

Glazing	$U_g =$	0.90	0.64	0.58	0.52	W/(m ² K)
		↓	↓	↓	↓	
Window	$U_W =$	0.97	0.78	0.74	0.70	W/(m ² K)

Transparent building components are classified into efficiency classes depending on the heat losses through the opaque part. The frame U-Values, frame widths, thermal bridges at the glazing edge, and the glazing edge lengths are included in these heat losses. A more detailed report of the calculations performed in the context of certification is available from the manufacturer.

The Passive House Institute has defined international component criteria for seven climate zones. In principle, components which have been certified for climate zones with higher requirements may also be used in climates with less stringent requirements. In a particular climate zone it may make sense to use a component of a higher thermal quality which has been certified for a climate zone with more stringent requirements.

Further information relating to certification can be found on www.passivehouse.com and passipedia.org.

Validated installations

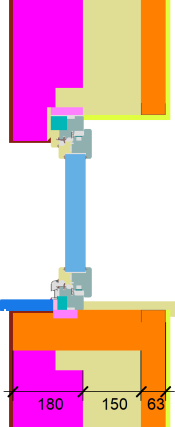
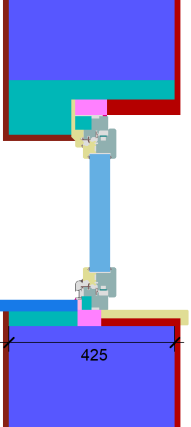
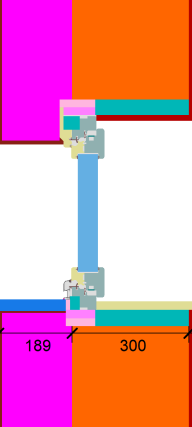
Solid timber (operable)	Monolithic construction (operable)	Exterior insulation and finishing system (EIFS) (operable)
$U_{\text{Wall}} = 0.12 \text{ W}/(\text{m}^2 \text{ K})$	$U_{\text{Wall}} = 0.20 \text{ W}/(\text{m}^2 \text{ K})$	$U_{\text{Wall}} = 0.16 \text{ W}/(\text{m}^2 \text{ K})$
		
Ψ_{install} W/(m K)	Ψ_{install} W/(m K)	Ψ_{install} W/(m K)
Top 0.010	Top 0.010	Top 0.012
Side 0.010	Side 0.010	Side 0.012
Bottom 0.011	Bottom 0.035	Bottom 0.042
$U_{W,\text{installed}} = 1.00 \text{ W}/(\text{m}^2 \text{ K})$	$U_{W,\text{installed}} = 1.01 \text{ W}/(\text{m}^2 \text{ K})$	$U_{W,\text{installed}} = 1.02 \text{ W}/(\text{m}^2 \text{ K})$

Frame values		Frame width b_f mm	U -value frame U_f W/(m ² K)	Ψ -glazing edge Ψ_g W/(m K)	Temp. Factor $f_{Rsi=0.25}$ [-]
Flying Mullion (FM1)		130	1.07	0.023	0.70
Bottom (OB1)		109	0.99	0.024	0.72
Top (OH1)		109	0.91	0.023	0.73
Lateral (OJ1)		109	0.91	0.023	0.73
Spacer: Super Spacer TriSeal / T-Spacer Premium			Secondary seal: Polyurethan		

