

CERTIFICATE

Certified Passive House Component

Component-ID 1126wi05 valid until 31st December 2025

Passive House Institute
Dr. Wolfgang Feist
64283 Darmstadt
Germany

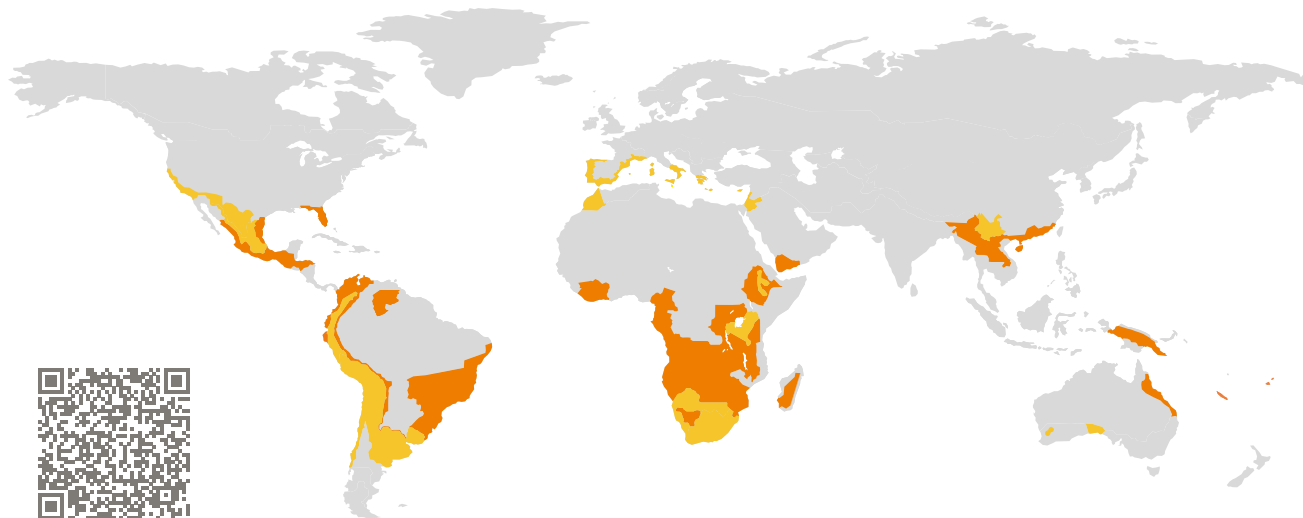

Category: **Window Frame**
Manufacturer: **Logikhaus PTY LTD,
Canberra,
Australia**
Product name: **LogikWin 68**

**This certificate was awarded based on the following
criteria for the warm climate zone**

Comfort $U_W = 1.20 \leq 1.20 \text{ W}/(\text{m}^2 \text{ K})$
 $U_{W, \text{installed}} \leq 1.25 \text{ W}/(\text{m}^2 \text{ K})$
with $U_g = 1.10 \text{ W}/(\text{m}^2 \text{ K})$

Hygiene $f_{Rsi=0.25} \geq 0.55$

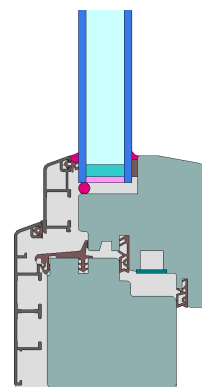

Passive House
efficiency class

phE

phD

phC

phB

phA

www.passivehouse.com

warm climate



**CERTIFIED
COMPONENT**

Passive House Institute

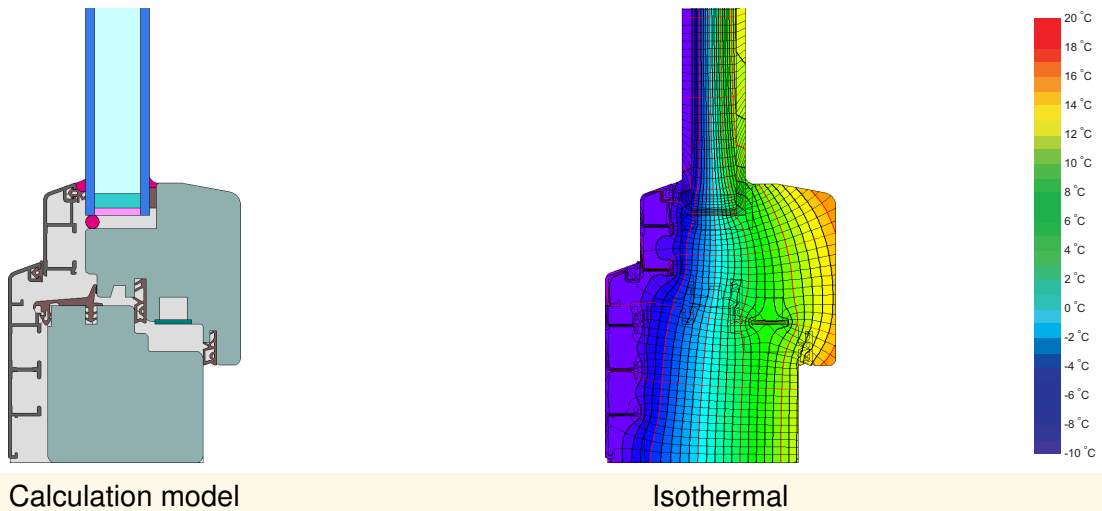

Description

Timberframe (0.11 W/(mK)) with aluminium facing shell. Pane thickness: 28 mm (4/20/4), rebate depth: 14 mm, spacer: Rolltech Multitech. Valid certified component for the warm-temperate climate zone is 1093wi04.

Explanation

The window U-values were calculated for the test window size of 1.23 m × 1.48 m with $U_g = 1.10$ W/(m² K). If a higher quality glazing is used, the window U-values will improve as follows:

Glazing	$U_g =$	1.10	1.05	0.95	0.90	W/(m ² K)
		↓	↓	↓	↓	
Window	$U_w =$	1.20	1.17	1.10	1.07	W/(m ² K)





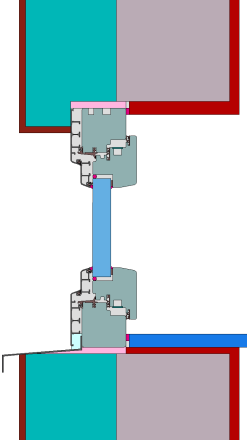
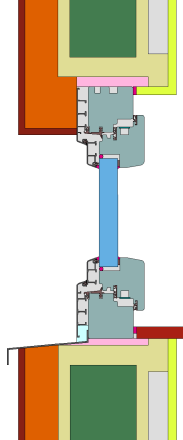
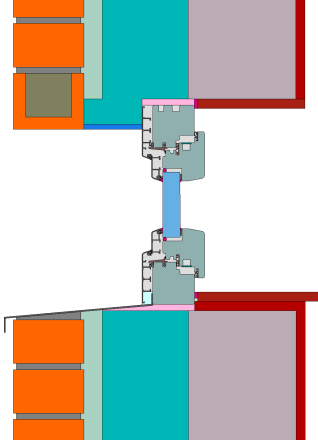

Transparent building components are classified into efficiency classes depending on the heat losses through the opaque part. The frame U-Values, frame widths, thermal bridges at the glazing edge, and the glazing edge lengths are included in these heat losses. A more detailed report of the calculations performed in the context of certification is available from the manufacturer.

The Passive House Institute has defined international component criteria for seven climate zones. In principle, components which have been certified for climate zones with higher requirements may also be used in climates with less stringent requirements. In a particular climate zone it may make sense to use a component of a higher thermal quality which has been certified for a climate zone with more stringent requirements.

Further information relating to certification can be found on www.passivehouse.com and passipedia.org.

Validated installations

Exterior insulation and finishing system		Lightweight timber (operable)		Cavity wall	
$U_{Wall} = 0.23 \text{ W}/(\text{m}^2 \text{ K})$		$U_{Wall} = 0.24 \text{ W}/(\text{m}^2 \text{ K})$		$U_{Wall} = 0.22 \text{ W}/(\text{m}^2 \text{ K})$	
					
$\Psi_{install}$	W/(m K)	$\Psi_{install}$	W/(m K)	$\Psi_{install}$	W/(m K)
Top	0.013	Top	0.013	Top	0.013
Side	0.013	Side	0.013	Side	0.013
Bottom	0.021	Bottom	0.032	Bottom	0.023
$U_{W,installed} = 1.24 \text{ W}/(\text{m}^2 \text{ K})$		$U_{W,installed} = 1.25 \text{ W}/(\text{m}^2 \text{ K})$		$U_{W,installed} = 1.25 \text{ W}/(\text{m}^2 \text{ K})$	

Frame values			Frame width b_f mm	U-value frame U_f W/(m ² K)	Ψ -glazing edge Ψ_g W/(m K)	Temp. Factor $f_{Rsi=0.25}$ [-]
Mullion 2 casements	(2M1)		188	1.20	0.028	0.61
Transom 2 casements	(2T1)		188	1.22	0.028	0.61
Flying Mullion	(FM1)		134	1.25	0.028	0.60
Bottom	(OB1)		123	1.20	0.028	0.61
Top	(OH1)		123	1.19	0.028	0.61
Lateral	(OJ1)		123	1.19	0.028	0.61
Spacer: MULTITECH			Secondary seal: Polysulfide			

