

CERTIFICATE

Certified Passive House Component

Component-ID 0162cw03 valid until 31st December 2025

Passive House Institute
Dr. Wolfgang Feist
64283 Darmstadt
Germany

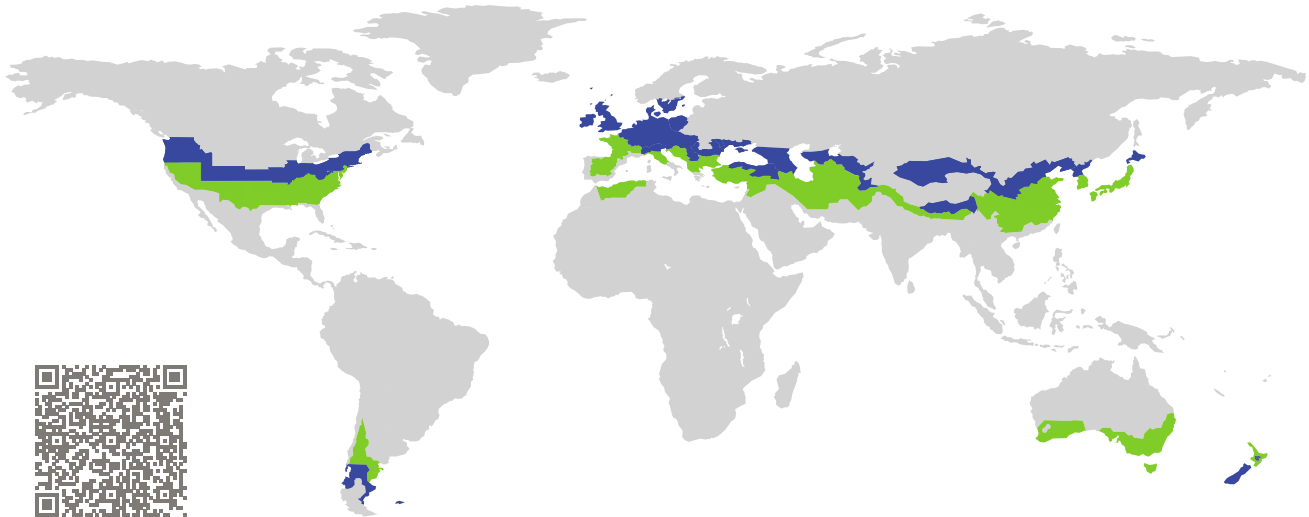

Category: **Curtain Wall**
Manufacturer: **RAICO Bautechnik GmbH,
Pfaffenhausen,
Germany**
Product name: **THERM+ 56 A-V**

**This certificate was awarded based on the following
criteria for the cool, temperate climate zone**

Comfort $U_{CW=0.80} \leq 0.80 \text{ W}/(\text{m}^2 \text{ K})$
 $U_{CW,installed} \leq 0.85 \text{ W}/(\text{m}^2 \text{ K})$
with $U_g = 0.70 \text{ W}/(\text{m}^2 \text{ K})$

Hygiene $f_{Rsi=0.25} \geq 0.70$

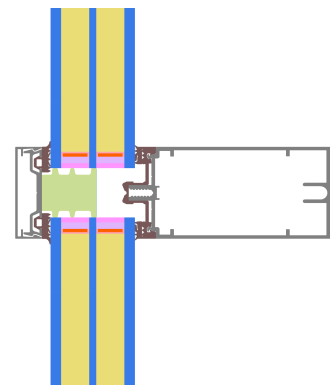

Passive House
efficiency class

phE

phD

phC

phB

phA

cool, temperate climate



**CERTIFIED
COMPONENT**

Passive House Institute

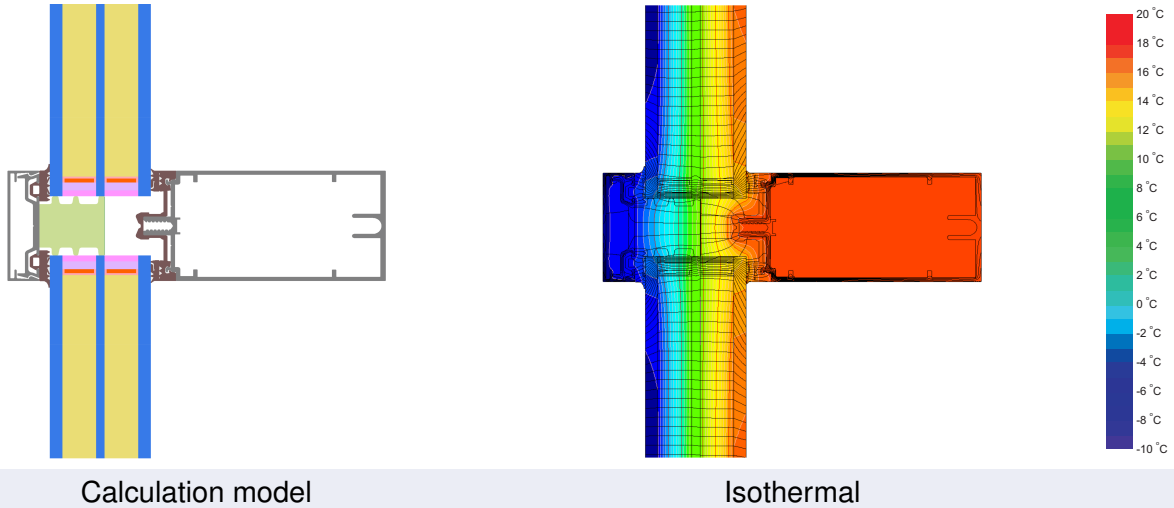

Description

Aluminium construction, Aluminium covering- and pressure-strip. PE-foam insulator in the glazing rebate, inside covered by reflecting Aluminium foil ($\epsilon = 0.05$). Plastic glass-carrier on stainless steel screws. Used Pane: 48 mm (6/16/4/16/6), intersection of the Glass: 13 mm. Used spacer:Swisspacer V. The glazing was calculated with a 3 mm secondary seal. As it is often the case that this is thicker, today the calculation is carried out with a 6 mm secondary seal. This leads to a higher glazing edge thermal bridge, which can also be estimated by way of the spacer certificates: www.passivhauskomponenten.org / glazing edge bonds. The higher rates of heat loss can be compensated for by using e. g. improved glazing.

Explanation





The element U-values were calculated for the test element size of 1.20 m x 2.50 m with $U_g = 0.70 \text{ W}/(\text{m}^2 \text{ K})$. If a higher quality glazing is used, the element U-values will improve as follows:

Glazing	$U_g =$	0.70	0.69	0.58	0.53	$\text{W}/(\text{m}^2 \text{ K})$
		↓	↓	↓	↓	
Element	U_{CW}	0.80	0.80	0.69	0.65	$\text{W}/(\text{m}^2 \text{ K})$

Transparent building components are sorted into efficiency classes depending on the heat losses through the opaque part. The frame U-Values, frame widths, thermal bridges at the glazing edge and the glazing edge lengths are included in these heat losses. A more detailed report of the calculations performed in the context of certification is available from the manufacturer.

The Passive House Institute has defined international component criteria for seven climate zones. In principle, components that have been certified for climate zones with higher thermal requirements may also be used in climates with less stringent requirements. In a particular climate zone it may make sense to use a component of a higher thermal quality which has been certified for a climate zone with more stringent requirements.

Further information relating to certification can be found on www.passivehouse.com and passipedia.org.

Frame values			Frame width b_f mm	U -value frame U_f^1 W/(m ² K)	Ψ -glazing edge Ψ_g W/(m K)	Temp. Factor $f_{RSi=0.25}$ [-]
Mullion fixed	(OM1)		56	0.85	0.038	0.83
Transom fixed	(OT1)		56	0.85	0.038	0.83
Bottom fixed	(FB1)		56	0.85	0.038	0.83
Top fixed	(FH1)		56	0.85	0.038	0.83
Lateral fixed	(FJ1)		56	0.85	0.038	0.83
			Spacer: SWISSPACER V		Secondary seal: Polysulfide	

Thermal glass carrier bridge² $\chi_{GT} = 0.005$ W/K

Validated installations

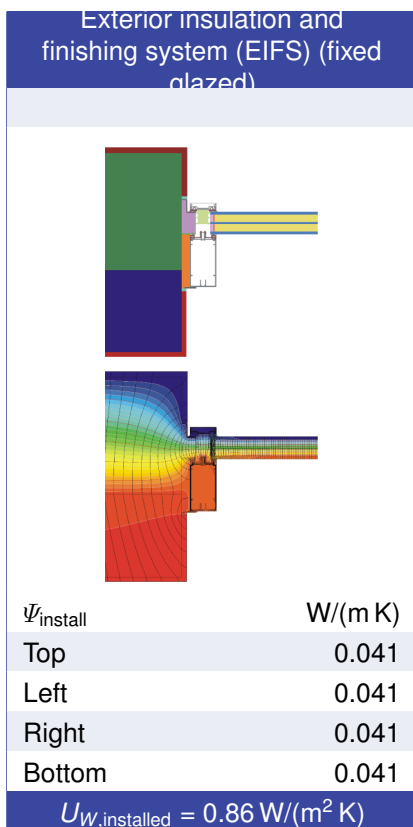

¹ Includes $\Delta U = 0.20$ W/(m² K). Determined through measurement

² Determined through 3D FEM simulation. Glass carrier type: Non-metallic glass carrier with screws

