

CERTIFICATE

Certified Passive House Component

Component-ID 1059wi03 valid until 31st December 2025

Passive House Institute
Dr. Wolfgang Feist
64283 Darmstadt
Germany

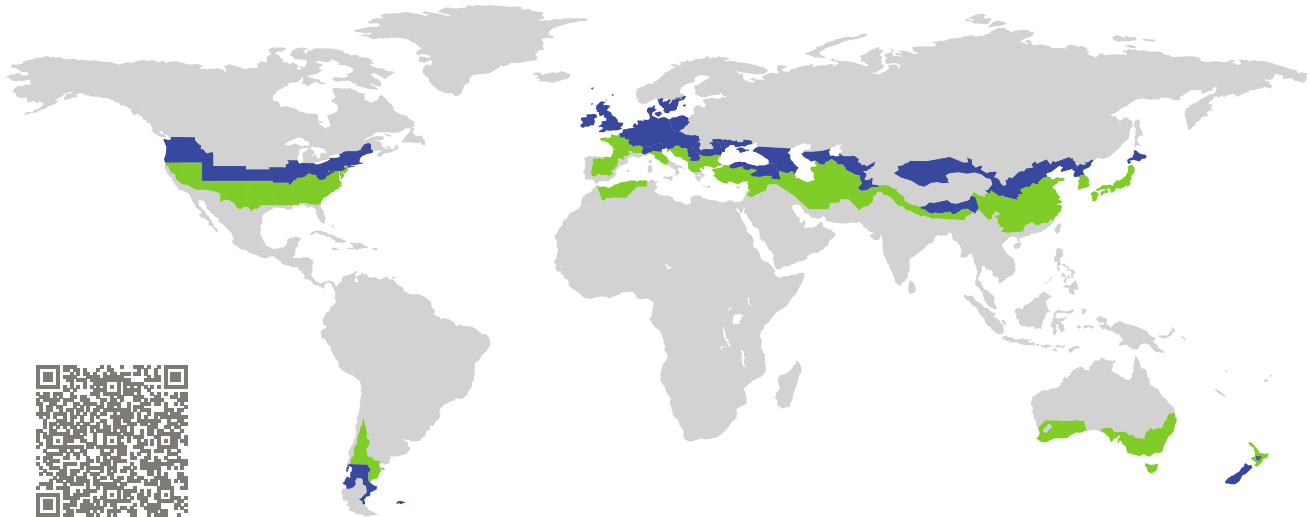

Category: **Window Frame**
Manufacturer: **Shandong Huajian Aluminium Group Co.,LTD, Shandong Province, China**
Product name: **ES101**

This certificate was awarded based on the following criteria for the cool, temperate climate zone

Comfort $U_W = 0.79 \leq 0.80 \text{ W}/(\text{m}^2 \text{ K})$
 $U_{W,\text{installed}} \leq 0.85 \text{ W}/(\text{m}^2 \text{ K})$
with $U_g = 0.70 \text{ W}/(\text{m}^2 \text{ K})$

Hygiene $f_{Rsi=0.25} \geq 0.70$

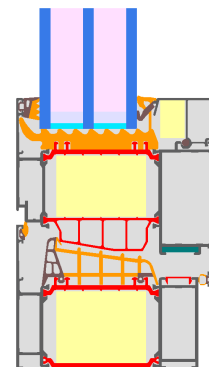

cool, temperate climate



CERTIFIED COMPONENT

Passive House Institute

Passive House
efficiency class

phE

phD

phC

phB

phA

www.passivehouse.com

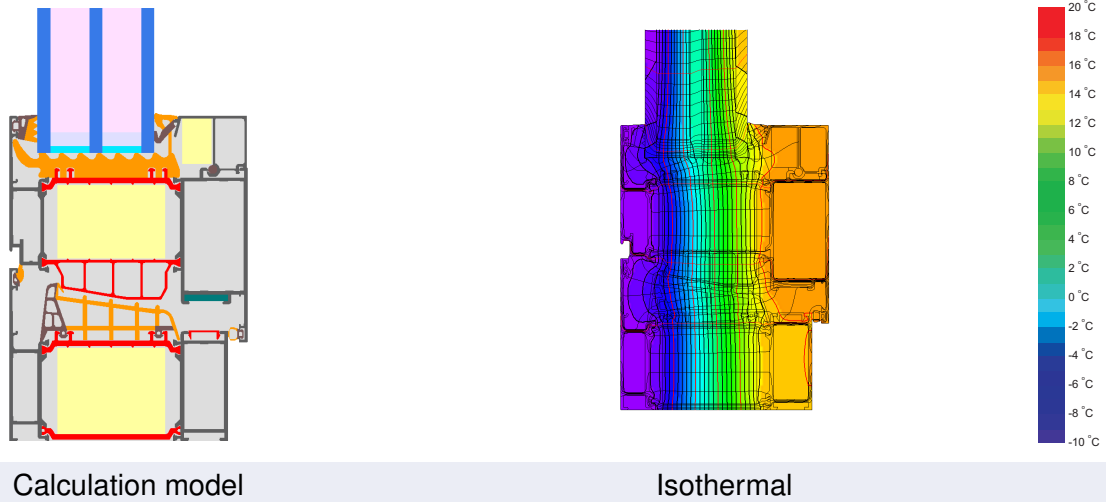

Calculation model Isothermal

Description

Thermally separated aluminium frame; insulated with resol foam (0,023W/(mK)) Pane thickness: 54 mm (6/18/6/18/6), rebate depth: 17 mm, spacer: TGI-Spacer Precision with polyurethane as secondary seal

Explanation

The window U-values were calculated for the test window size of 1.23 m × 1.48 m with $U_g = 0.70 \text{ W}/(\text{m}^2 \text{ K})$. If a higher quality glazing is used, the window U-values will improve as follows:

Glazing	$U_g =$	0.70	0.64	0.58	0.52	$\text{W}/(\text{m}^2 \text{ K})$
		↓	↓	↓	↓	
Window	$U_W =$	0.79	0.76	0.72	0.69	$\text{W}/(\text{m}^2 \text{ K})$





Transparent building components are classified into efficiency classes depending on the heat losses through the opaque part. The frame U-Values, frame widths, thermal bridges at the glazing edge, and the glazing edge lengths are included in these heat losses. A more detailed report of the calculations performed in the context of certification is available from the manufacturer.

The Passive House Institute has defined international component criteria for seven climate zones. In principle, components which have been certified for climate zones with higher requirements may also be used in climates with less stringent requirements. In a particular climate zone it may make sense to use a component of a higher thermal quality which has been certified for a climate zone with more stringent requirements.

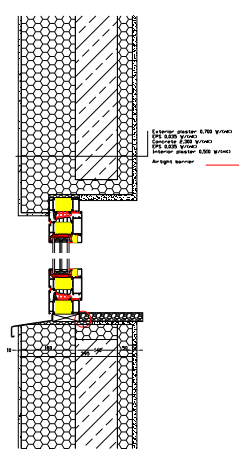
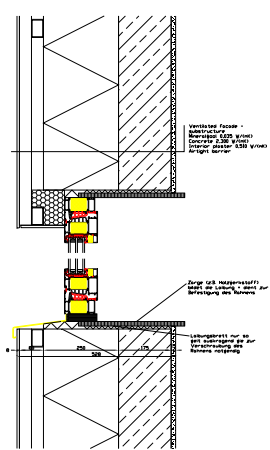
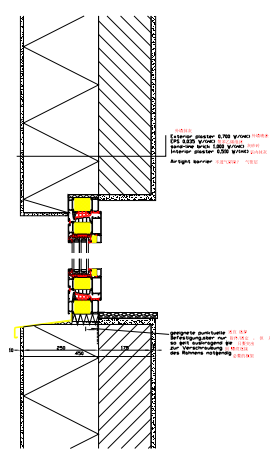
Further information relating to certification can be found on www.passivehouse.com and passipedia.org.

Validated installations

Formwork blocks (operable)	Ventilated facade	Exterior insulation and finishing system (EIFS) (operable)
$U_{Wall} = 0.15 \text{ W}/(\text{m}^2 \text{ K})$	$U_{Wall} = 0.13 \text{ W}/(\text{m}^2 \text{ K})$	$U_{Wall} = 0.13 \text{ W}/(\text{m}^2 \text{ K})$
		
$\Psi_{install}$ W/(m K)	$\Psi_{install}$ W/(m K)	$\Psi_{install}$ W/(m K)
Top 0.012	Top 0.017	Top 0.014
Side 0.012	Side 0.017	Side 0.014
Bottom 0.045	Bottom 0.024	Bottom 0.025
$U_{W,installed} = 0.85 \text{ W}/(\text{m}^2 \text{ K})$	$U_{W,installed} = 0.85 \text{ W}/(\text{m}^2 \text{ K})$	$U_{W,installed} = 0.84 \text{ W}/(\text{m}^2 \text{ K})$

Frame values	Frame width b_f mm	U -value frame U_f W/(m ² K)	Ψ -glazing edge Ψ_g W/(m K)	Temp. Factor $f_{Rsi=0.25}$ [-]
Flying Mullion (FM1) 	167	0.81	0.022	0.76
Bottom (OB1) 	150	0.81	0.022	0.76
Top (OH1) 	150	0.81	0.022	0.76
Lateral (OJ1) 	150	0.81	0.022	0.76
Spacer: Technoform-Spacer SP16		Secondary seal: Polyurethan		

