

CERTIFICATE

Certified Passive House Component

Component-ID 1610pm04 valid until 31st December 2025

Passive House Institute
Dr. Wolfgang Feist
64283 Darmstadt
Germany

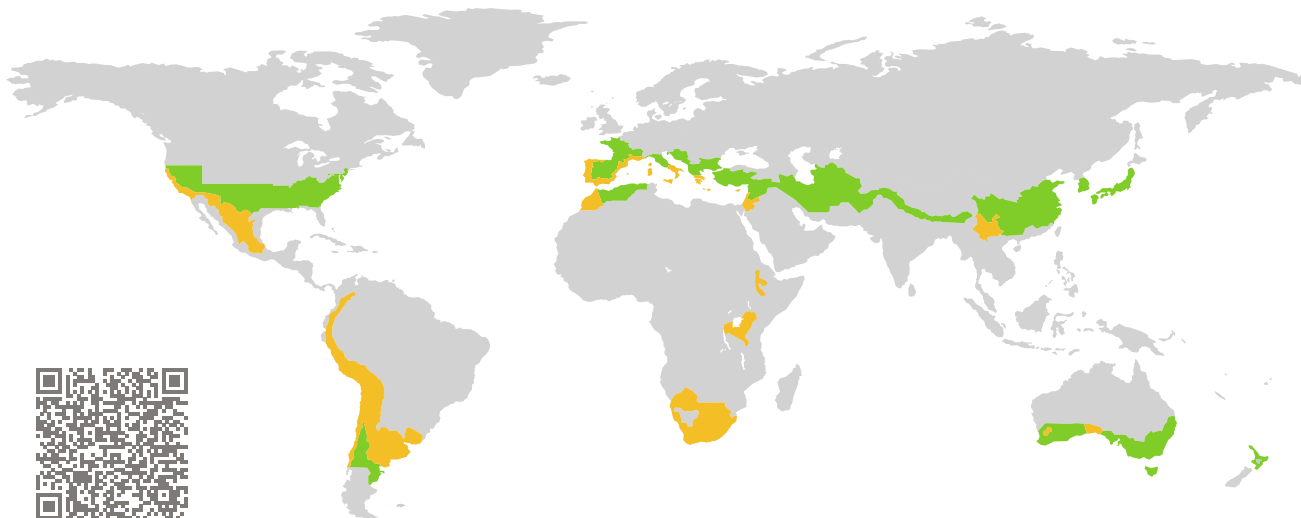

Category: **Window mounting system**
Manufacturer: **Soudal N.V.,
Turnhout,
Belgium**
Product name: **SoudaFrame SWI**

**This certificate was awarded based on the following
criteria for the warm, temperate climate zone**

Comfort $U_{W,installed} \leq 1.05 \text{ W}/(\text{m}^2 \cdot \text{K})$
with $U_g = 0.90 \text{ W}/(\text{m}^2 \cdot \text{K})$

Hygiene $f_{Rsi=0.25} \geq 0.65$

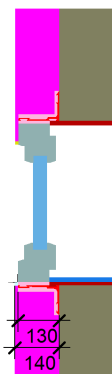

warm, temperate climate

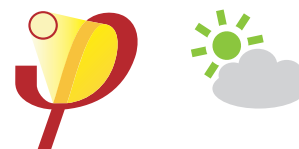

**CERTIFIED
COMPONENT**

Passive House Institute

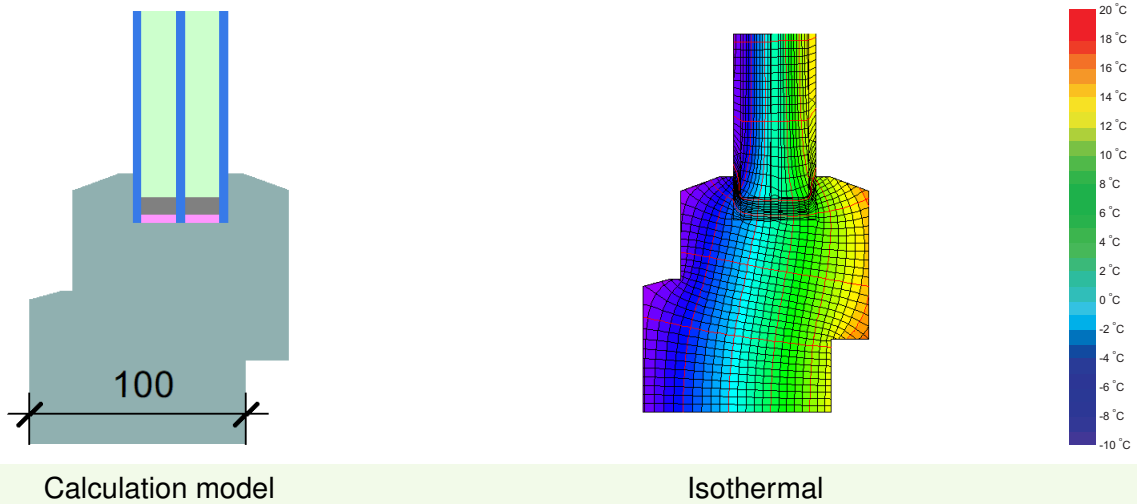

Calculation model Isothermal

Description

Window mounting system made from GRP (0,19 W/(mK)), system width 90, 130 160, 200 mm. Assembly by way of adhesive and mechanical fixing. Additional thermal losses by reinforcing brackets made from steel determined by 3D heat flux simulation. Losses are to be included where the load exceeds a certain level, see certification report.

Explanation

The window U-values were calculated for the test window size of 1.23 m × 1.48 m with $U_g = 0.90 \text{ W}/(\text{m}^2 \cdot \text{K})$. If a higher quality glazing is used, the window U-values will improve as follows:



Glazing	$U_g =$	0.90	0.66	0.61	0.56	$\text{W}/(\text{m}^2 \cdot \text{K})$
		↓	↓	↓	↓	
Window	$U_W =$	1.00	0.84	0.81	0.77	$\text{W}/(\text{m}^2 \cdot \text{K})$



Transparent building components are classified into efficiency classes depending on the heat losses through the opaque part. The frame U-Values, frame widths, thermal bridges at the glazing edge, and the glazing edge lengths are included in these heat losses. A more detailed report of the calculations performed in the context of certification is available from the manufacturer.

The Passive House Institute has defined international component criteria for seven climate zones. In principle, components which have been certified for climate zones with higher requirements may also be used in climates with less stringent requirements. In a particular climate zone it may make sense to use a component of a higher thermal quality which has been certified for a climate zone with more stringent requirements.

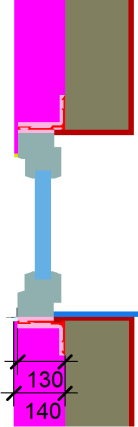
Further information relating to certification can be found on www.passivehouse.com and passipedia.org.

Validated installations

Mounting System Timber/PVC completely covered by insul		Mounting System Timber/PVC not covered by insulation		Mounting System Timber/PVC partially covered by insul	
$U_{Wall} = 0.22 \text{ W}/(\text{m}^2 \cdot \text{K})$		$U_{Wall} = 0.22 \text{ W}/(\text{m}^2 \cdot \text{K})$		$U_{Wall} = 0.22 \text{ W}/(\text{m}^2 \cdot \text{K})$	
					
$\Psi_{install}$	W/(m · K)	$\Psi_{install}$	W/(m · K)	$\Psi_{install}$	W/(m · K)
Top	0.007	Top	0.013	Top	0.011
Side	0.007	Side	0.013	Side	0.011
Bottom	0.015	Bottom	0.015	Bottom	0.015
$U_{W,installed} = 1.03 \text{ W}/(\text{m}^2 \cdot \text{K})$		$U_{W,installed} = 1.04 \text{ W}/(\text{m}^2 \cdot \text{K})$		$U_{W,installed} = 1.03 \text{ W}/(\text{m}^2 \cdot \text{K})$	

Frame values		Frame width b_f mm	U -value frame U_f W/(m ² · K)	Ψ -glazing edge Ψ_g W/(m · K)	Temp. Factor $f_{Rsi=0.25}$ [-]
Bottom	(OB1) 	125	0.92	0.038	0.67
Top	(OH1) 	125	0.92	0.038	0.67
Lateral	(OJ1) 	125	0.92	0.038	0.67
Spacer: PHI phB-Spacer		Secondary seal: Polysulfide			

