

# CERTIFICATE

Certified Passive House Component

Component-ID 1089wi04 valid until 31st December 2021

Passive House Institute  
Dr. Wolfgang Feist  
64283 Darmstadt  
Germany

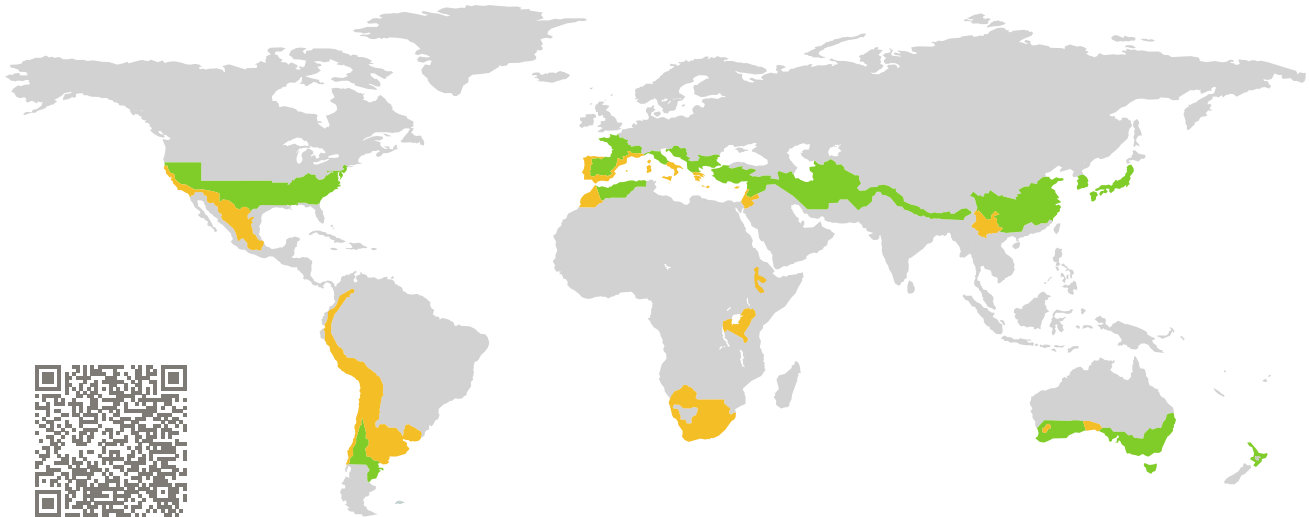

Category: **Window Frame**  
Manufacturer: **Industrias REHAU,  
Gavá,  
Spain**  
Product name: **SYNEGO**

**This certificate was awarded based on the following  
criteria for the warm, temperate climate zone**

Comfort  $U_W = 1.00 \leq 1.00 \text{ W}/(\text{m}^2 \text{ K})$   
 $U_{W,\text{installed}} \leq 1.05 \text{ W}/(\text{m}^2 \text{ K})$   
with  $U_g = 0.90 \text{ W}/(\text{m}^2 \text{ K})$

Hygiene  $f_{Rsi=0.25} \geq 0.65$

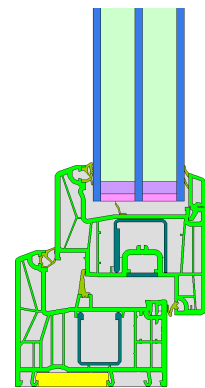

Passive House  
efficiency class

phE

phD

phC

phB

phA

[www.passivehouse.com](http://www.passivehouse.com)

warm, temperate climate



**CERTIFIED  
COMPONENT**

Passive House Institute

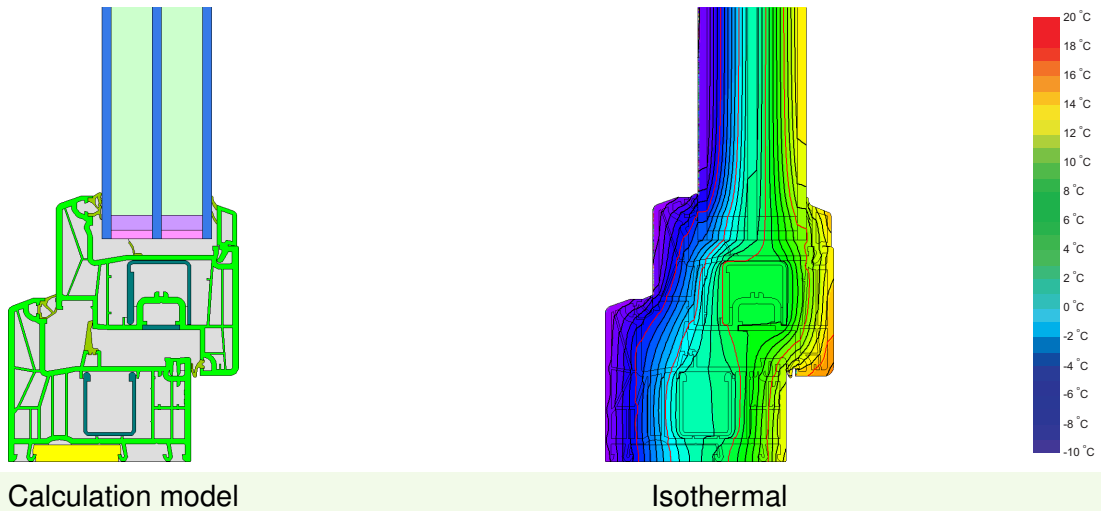

Calculation model Isothermal

**Description**

PVC-frame with steel-reinforcements and insulation (0.031 W/(mK)) inside the main-frame. Pane thickness: 48 mm (4/18/4/18/4), rebate depth: 19 mm. Spacer: SWISSPACER Ultimate.

**Explanation**





The window U-values were calculated for the test window size of 1.23 m × 1.48 m with  $U_g = 0.90$  W/(m<sup>2</sup> K). If a higher quality glazing is used, the window U-values will improve as follows:

Glazing	$U_g =$	0.90	0.70	0.68	0.64	W/(m <sup>2</sup> K)
		↓	↓	↓	↓	
Window	$U_W =$	1.00	0.87	0.85	0.83	W/(m <sup>2</sup> K)

Transparent building components are classified into efficiency classes depending on the heat losses through the opaque part. The frame U-Values, frame widths, thermal bridges at the glazing edge, and the glazing edge lengths are included in these heat losses. A more detailed report of the calculations performed in the context of certification is available from the manufacturer.

The Passive House Institute has defined international component criteria for seven climate zones. In principle, components which have been certified for climate zones with higher requirements may also be used in climates with less stringent requirements. In a particular climate zone it may make sense to use a component of a higher thermal quality which has been certified for a climate zone with more stringent requirements.

Further information relating to certification can be found on [www.passivehouse.com](http://www.passivehouse.com) and [passipedia.org](http://passipedia.org).

Frame values			Frame width $b_f$ mm	$U$ -value frame $U_f$ W/(m <sup>2</sup> K)	$\Psi$ -panel edge $\Psi_g$ W/(m K)	Temp. Factor $f_{RSI=0.25}$ [-]
Top	(to)		117	1.03	0.026	0.72
Side	(s)		117	1.03	0.026	0.72
Bottom	(bo)		117	1.03	0.026	0.72
Mullion flying	(fm)		164	0.99	0.025	0.63
			Spacer: SWISSPACER Ultimate		Secondary seal: Polysulfid	

### Validated installations

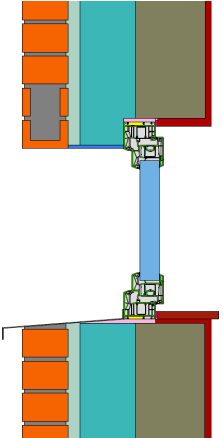
Cavity wall	
$U_{Wall} = 0.22 \text{ W/(m}^2 \text{ K)}$	
	
$\Psi_{install}$	W/(m K)
Top	0.009
Side	0.009
Bottom	0.044
$U_{W,installed} = 1.05 \text{ W/(m}^2 \text{ K)}$	

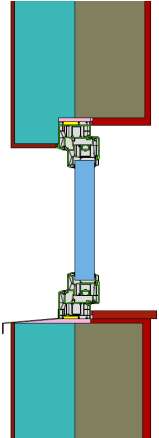
Exterior insulation and finishing system	
$U_{Wall} = 0.22 \text{ W/(m}^2 \text{ K)}$	
	
$\Psi_{install}$	W/(m K)
Top	0.006
Side	0.006
Bottom	0.033
$U_{W,installed} = 1.04 \text{ W/(m}^2 \text{ K)}$	

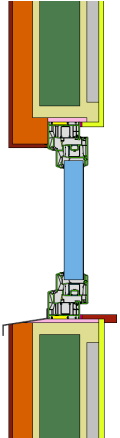
Lightweight timber (operable)	
$U_{Wall} = 0.20 \text{ W/(m}^2 \text{ K)}$	
	
$\Psi_{install}$	W/(m K)
Top	0.012
Side	0.012
Bottom	0.032
$U_{W,installed} = 1.05 \text{ W/(m}^2 \text{ K)}$	

