

# CERTIFICATE

Certified Passive House Component

Component-ID 0158cw03 valid until 31st December 2025

Passive House Institute  
Dr. Wolfgang Feist  
64283 Darmstadt  
Germany

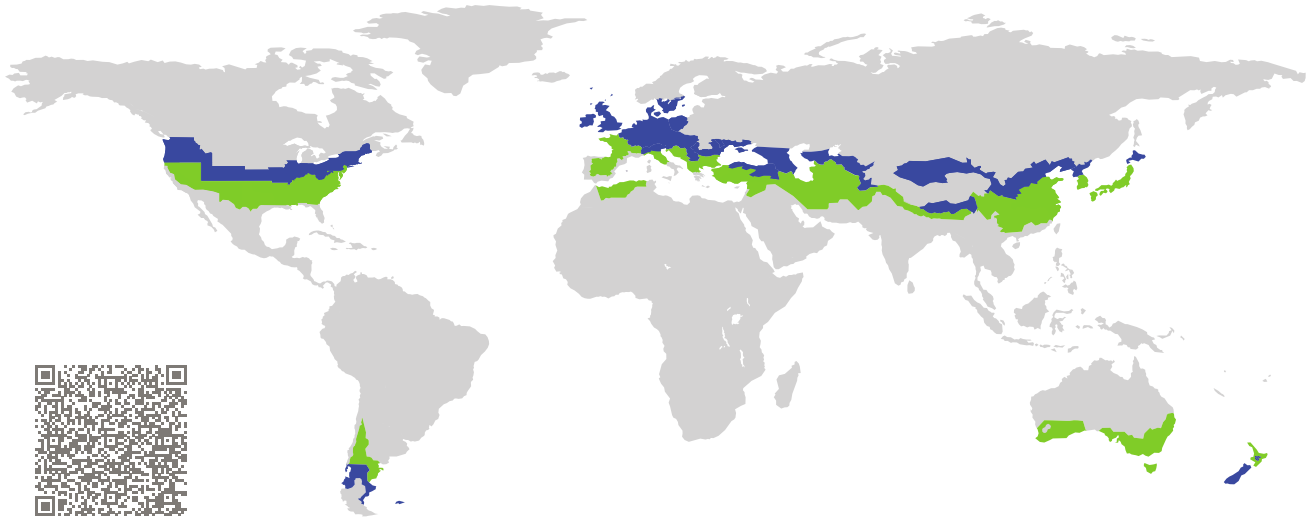

Category: **Curtain Wall**  
Manufacturer: **LAMILUX Heinrich Strunz GmbH,  
Rehau,  
Germany**  
Product name: **LAMILUX Glasdach PR60 Passivhaus  
(Fassade)**

**This certificate was awarded based on the following  
criteria for the cool, temperate climate zone**

Comfort  $U_{CW} = 0.79 \leq 0.80 \text{ W}/(\text{m}^2 \text{ K})$   
 $U_{CW, \text{installed}}$   $\leq 0.85 \text{ W}/(\text{m}^2 \text{ K})$   
with  $U_g$   $= 0.70 \text{ W}/(\text{m}^2 \text{ K})$

Hygiene  $f_{Rsi=0.25} \geq 0.70$

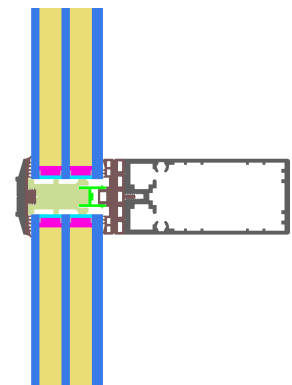

cool, temperate climate



**CERTIFIED  
COMPONENT**

Passive House Institute

Passive House  
efficiency class

phE

phD

phC

phB

phA

[www.passivehouse.com](http://www.passivehouse.com)

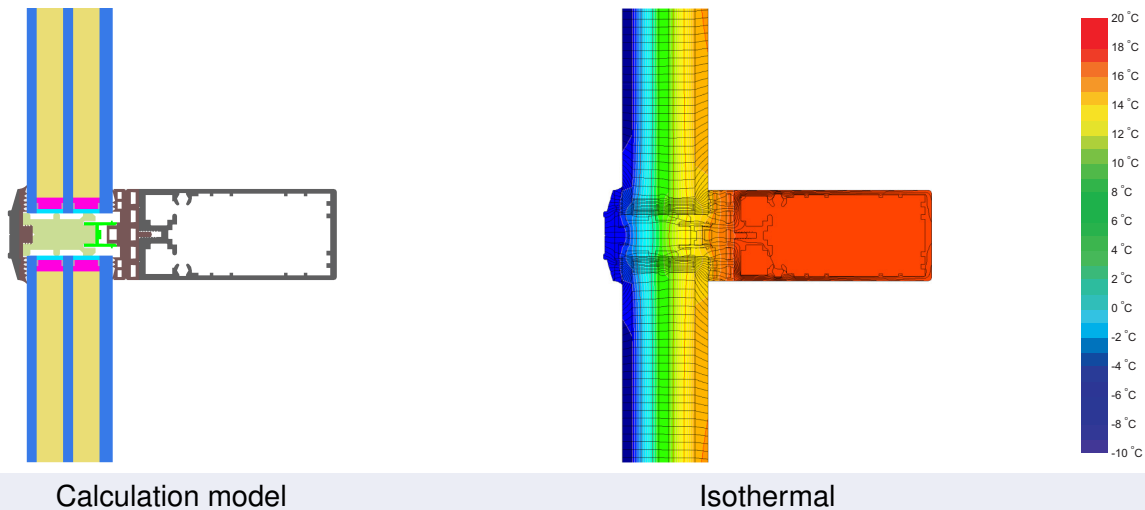

### Description

Aluminium construction, Aluminium pressure-strip. PE-foam insulator in the glazing rebate, plastic glass-carrier on stainless steel bolts. The losses by the screws were determined by measurement (ift), the losses caused by the glass carrier by 3D-simulation (PHI). Used Pane: 52 mm (6/16/6/16/8), intersection of the Glass: 16 mm. Used spacer: SuperSp. TriSeal PU. The glazing was calculated with a 3 mm secondary seal. As it is often the case that this is thicker, today the calculation is carried out with a 6 mm secondary seal. This leads to a higher glazing edge thermal bridge, which can also be estimated by way of the spacer certificates: [www.passivhauskomponenten.org](http://www.passivhauskomponenten.org) / glazing edge bonds. The higher rates of heat loss can be compensated for by using e. g. improved glazing.

### Explanation





The element U-values were calculated for the test element size of 1.20 m × 2.50 m with  $U_g = 0.70 \text{ W}/(\text{m}^2 \text{ K})$ . If a higher quality glazing is used, the element U-values will improve as follows:

Glazing	$U_g =$	0.70	0.69	0.58	0.53	$\text{W}/(\text{m}^2 \text{ K})$
		↓	↓	↓	↓	
Element	$U_{CW}$	0.79	0.79	0.68	0.64	$\text{W}/(\text{m}^2 \text{ K})$

Transparent building components are sorted into efficiency classes depending on the heat losses through the opaque part. The frame U-Values, frame widths, thermal bridges at the glazing edge and the glazing edge lengths are included in these heat losses. A more detailed report of the calculations performed in the context of certification is available from the manufacturer.

The Passive House Institute has defined international component criteria for seven climate zones. In principle, components that have been certified for climate zones with higher thermal requirements may also be used in climates with less stringent requirements. In a particular climate zone it may make sense to use a component of a higher thermal quality which has been certified for a climate zone with more stringent requirements.

Further information relating to certification can be found on [www.passivehouse.com](http://www.passivehouse.com) and [passipedia.org](http://passipedia.org).

Frame values			Frame width $b_f$ mm	$U$ -value frame $U_f$ <sup>1</sup> W/(m <sup>2</sup> K)	$\Psi$ -glazing edge $\Psi_g$ W/(m K)	Temp. Factor $f_{Rsi=0.25}$ [-]
Mullion fixed	(OM1)		60	0.85	0.033	0.79
Transom fixed	(OT1)		60	0.85	0.033	0.79
Bottom fixed	(FB1)		60	0.85	0.033	0.79
Top fixed	(FH1)		60	0.85	0.033	0.79
Lateral fixed	(FJ1)		60	0.85	0.033	0.79
Spacer: Super Spacer TriSeal / T-Spacer Premium			Secondary seal: Polyurethan			

Thermal glass carrier bridge<sup>2</sup>  $\chi_{GT} = 0.010$  W/K

### Validated installations

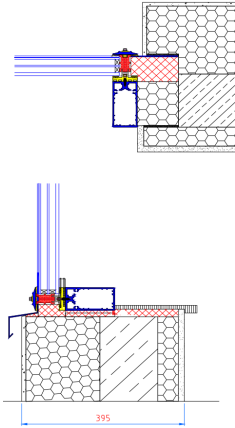
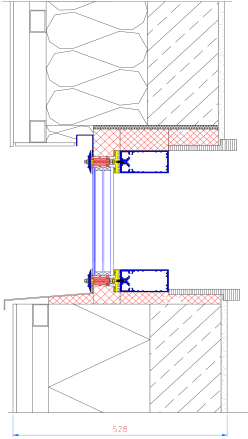
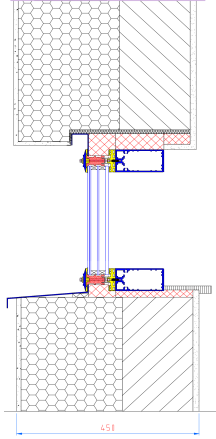
Formwork blocks (fixed)	Ventilated facade (fixed glazing)	Exterior insulation and finishing system (EIFS) (fixed glazed)
$U_{Wall} = 0.15$ W/(m <sup>2</sup> K)	$U_{Wall} = 0.13$ W/(m <sup>2</sup> K)	$U_{Wall} = 0.13$ W/(m <sup>2</sup> K)
		
$\Psi_{install}$ W/(m K)	$\Psi_{install}$ W/(m K)	$\Psi_{install}$ W/(m K)
Top 0.019	Top 0.020	Top 0.021
Left 0.019	Left 0.020	Left 0.021
Right 0.019	Right 0.020	Right 0.021
Bottom 0.026	Bottom 0.016	Bottom 0.022
$U_{W,installed} = 0.82$ W/(m <sup>2</sup> K)	$U_{W,installed} = 0.82$ W/(m <sup>2</sup> K)	$U_{W,installed} = 0.82$ W/(m <sup>2</sup> K)

<sup>1</sup> Includes  $\Delta U = 0.13$  W/(m<sup>2</sup> K). Determined through measurement

<sup>2</sup> Determined through 3D FEM simulation. Glass carrier type: Non-metallic glass carrier with screws

