

# CERTIFICATE

Certified Passive House Component

Component-ID 1260sl03 valid until 31st December 2025

Passive House Institute  
Dr. Wolfgang Feist  
64283 Darmstadt  
Germany

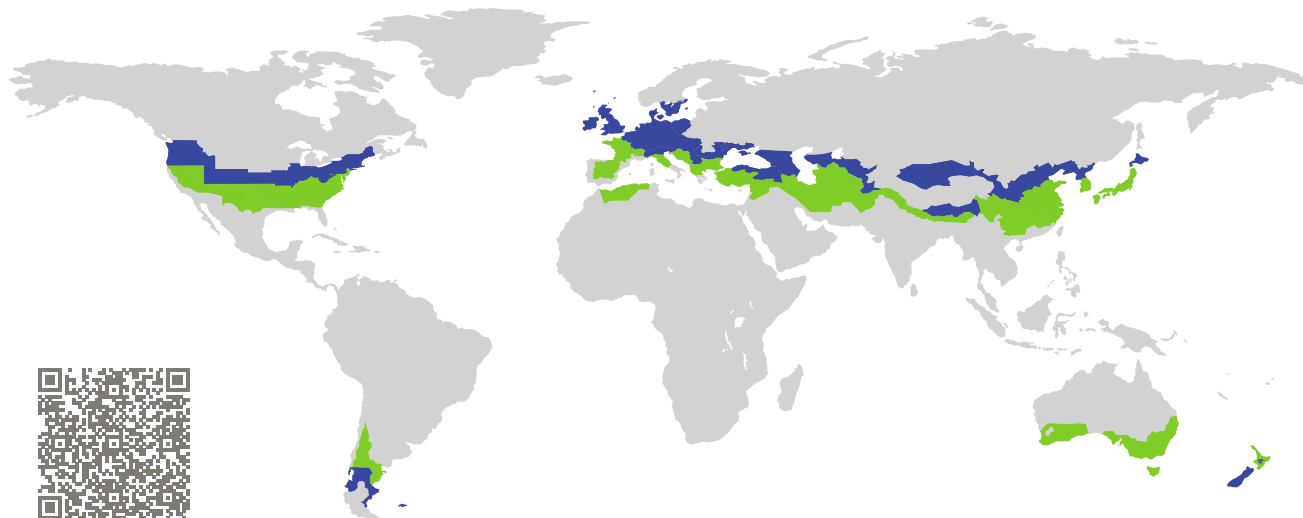

Category: **Sliding Door**  
Manufacturer: **Cascadia Windows & Doors,  
Langley, BC,  
Canada**  
Product name: **Cascadia Slider PH**

**This certificate was awarded based on the following  
criteria for the cool, temperate climate zone**

Comfort  $U_{SL=0.76} \leq 0.80 \text{ W}/(\text{m}^2 \text{ K})$   
 $U_{SL,installed} \leq 0.85 \text{ W}/(\text{m}^2 \text{ K})$   
with  $U_g = 0.70 \text{ W}/(\text{m}^2 \text{ K})$

Hygiene  $f_{Rsi=0.25} \geq 0.70$

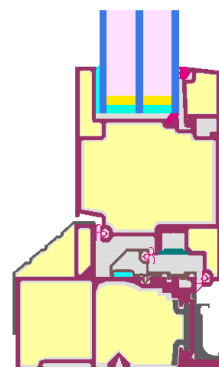

cool, temperate climate



**CERTIFIED  
COMPONENT**

Passive House Institute

Passive House  
efficiency class

phE

phD

phC

phB

phA

[www.passivehouse.com](http://www.passivehouse.com)

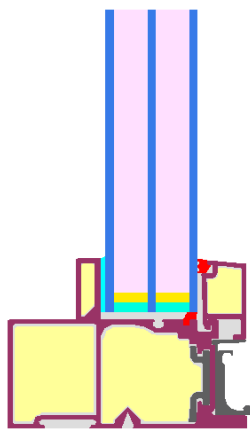

Calculation model

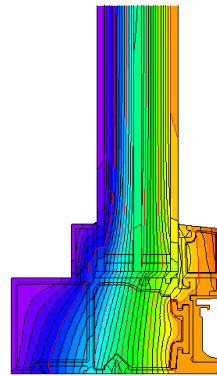

Isothermal

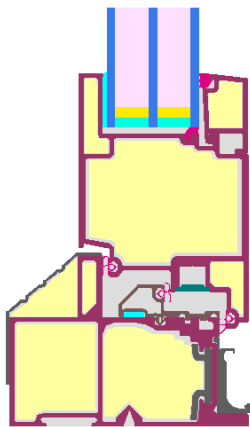
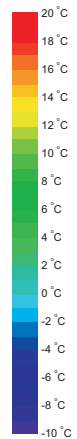

Calculation model

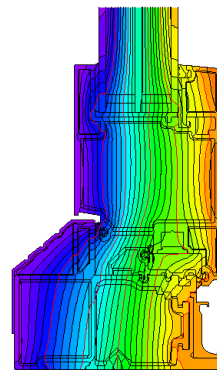

Isothermal

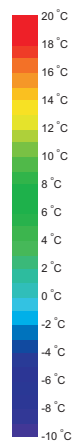

### Description

Fiberglass frame, insulated by Resolic foam (0.023 W/(mK)). Pane thickness: 44 mm (4/16/4/16/4), rebate depth: 26 mm, spacer: SuperSpacer Premium with butyl as secondary seal.

### Explanation







The window U-values were calculated for the test window size of 2.40 m × 2.50 m with  $U_g = 0.70 \text{ W}/(\text{m}^2 \text{ K})$ . If a higher quality glazing is used, the window U-values will improve as follows:

Glazing	$U_g =$	0.70	0.65	0.60	0.55	W/(m <sup>2</sup> K)
		↓	↓	↓	↓	
Window	$U_w =$	0.76	0.72	0.68	0.65	W/(m <sup>2</sup> K)

Transparent building components are classified into efficiency classes depending on the heat losses through the opaque part. The frame U-Values, frame widths, thermal bridges at the glazing edge, and the glazing edge lengths are included in these heat losses. A more detailed report of the calculations performed in the context of certification is available from the manufacturer.

The Passive House Institute has defined international component criteria for seven climate zones. In principle, components which have been certified for climate zones with higher requirements may also be used in climates with less stringent requirements. In a particular climate zone it may make sense to use a component of a higher thermal quality which has been certified for a climate zone with more stringent requirements.

Further information relating to certification can be found on [www.passivehouse.com](http://www.passivehouse.com) and [passipedia.org](http://passipedia.org).

Frame values			Frame width $b_f$ mm	U-value frame $U_f$ W/(m <sup>2</sup> K)	$\Psi$ -glazing edge $\Psi_g$ W/(m K)	Temp. Factor $f_{Rsi=0.25}$ [-]
Mullion 1 casement	(1M1)		202	0.74	0.020	0.76
Bottom fixed	(FB1)		81	0.74	0.022	0.80
Top fixed	(FH1)		81	0.76	0.023	0.81
Lateral fixed	(FJ1)		58	0.81	0.020	0.75
Top	(OH1)		168	0.79	0.021	0.74
Lateral	(OJ1)		158	0.73	0.020	0.76
Threshold	(OT2)		168	0.74	0.021	0.76

Spacer: Super Spacer Premium      Secondary seal: Butyl



**Mullion**  
1 casement

$b_f = 202$  mm

$U_f = 0.74$  W/(m<sup>2</sup> K)

$\Psi_g = 0.020$  W/(m K)

$f_{Rsi} = 0.76$

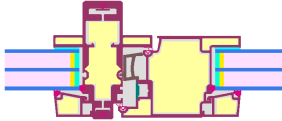
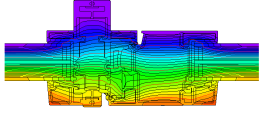

**Bottom**  
fixed

$b_f = 81$  mm

$U_f = 0.74$  W/(m<sup>2</sup> K)

$\Psi_g = 0.022$  W/(m K)

$f_{Rsi} = 0.80$

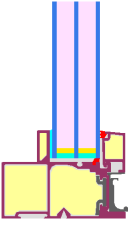
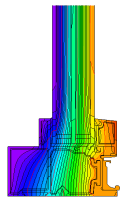

Top  
fixed

$$b_f = 81 \text{ mm}$$

$$U_f = 0.76 \text{ W/(m}^2 \text{ K)}$$

$$\Psi_g = 0.023 \text{ W/(m K)}$$

$$f_{Rsi} = 0.81$$

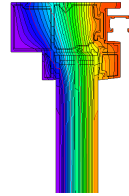
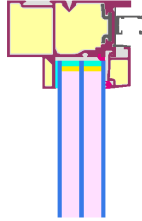

Lateral  
fixed

$$b_f = 58 \text{ mm}$$

$$U_f = 0.81 \text{ W/(m}^2 \text{ K)}$$

$$\Psi_g = 0.020 \text{ W/(m K)}$$

$$f_{Rsi} = 0.75$$

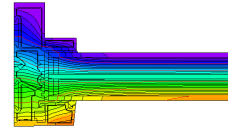
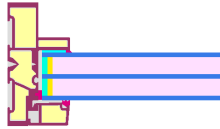

Top

$$b_f = 168 \text{ mm}$$

$$U_f = 0.79 \text{ W/(m}^2 \text{ K)}$$

$$\Psi_g = 0.021 \text{ W/(m K)}$$

$$f_{Rsi} = 0.74$$

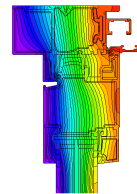
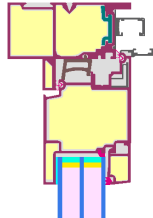

Lateral

$$b_f = 158 \text{ mm}$$

$$U_f = 0.73 \text{ W/(m}^2 \text{ K)}$$

$$\Psi_g = 0.020 \text{ W/(m K)}$$

$$f_{Rsi} = 0.76$$

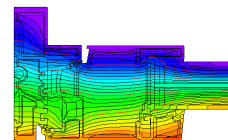
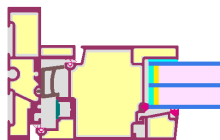

Threshold

$$b_f = 168 \text{ mm}$$

$$U_f = 0.74 \text{ W/(m}^2 \text{ K)}$$

$$\Psi_g = 0.021 \text{ W/(m K)}$$

$$f_{Rsi} = 0.76$$

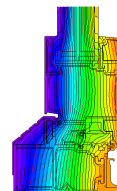

**Validated installations**

