

CERTIFICATE

Certified Passive House Component

Component-ID 1361wi04 valid until 31st December 2025

Passive House Institute
Dr. Wolfgang Feist
64283 Darmstadt
Germany

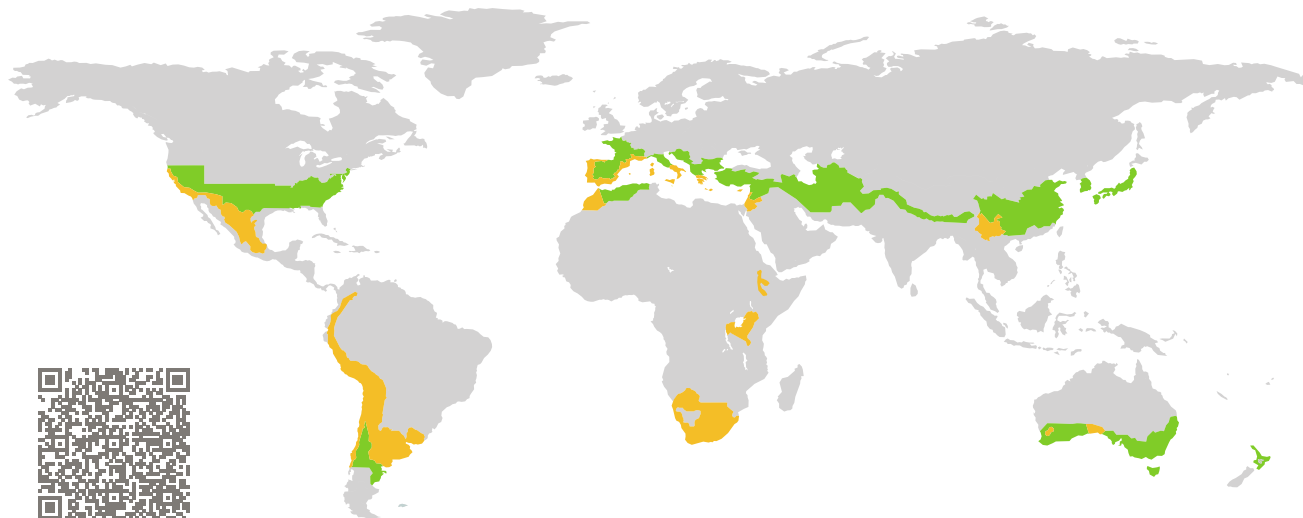

Category: **Window Frame**
Manufacturer: **Shandong Huajian Aluminium Group Co.,LTD, Shandong Province, China**
Product name: **ES91**

This certificate was awarded based on the following criteria for the warm, temperate climate zone

Comfort $U_{W=1.00} \leq 1.00 \text{ W}/(\text{m}^2 \text{ K})$
 $U_{W,\text{installed}} \leq 1.05 \text{ W}/(\text{m}^2 \text{ K})$
with $U_g = 0.90 \text{ W}/(\text{m}^2 \text{ K})$

Hygiene $f_{Rsi=0.25} \geq 0.65$

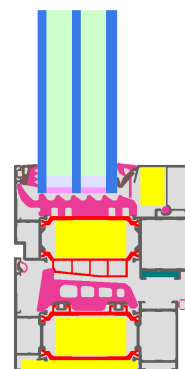

Passive House
efficiency class

phE

phD

phC

phB

phA

warm, temperate climate



**CERTIFIED
COMPONENT**

Passive House Institute

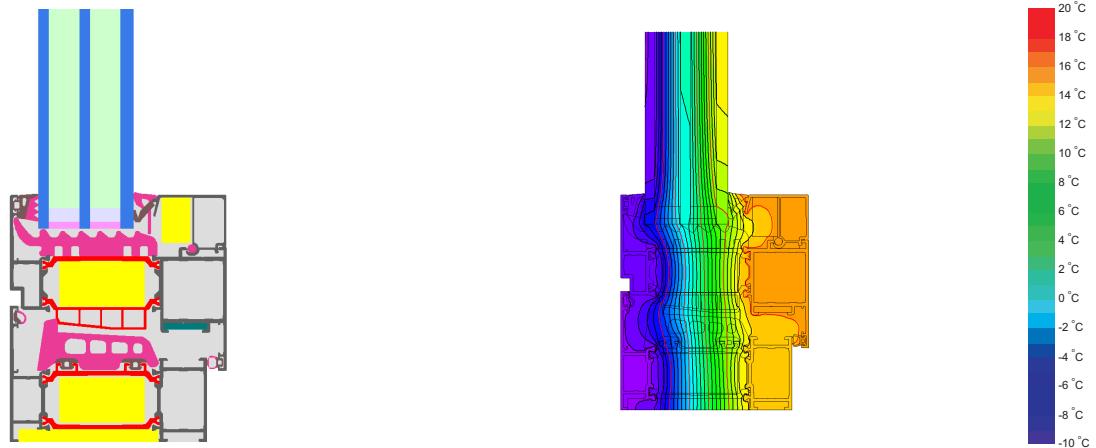

Calculation model

Isothermal

Description

Aluminium frame with thermal separation (PA 0.30 W/(mK)) and insulation (Resol foam 0.022 W/(mK));
 Pane thickness: 44 mm (6/14/5/14/5), rebate depth: 16 mm. Spacer: TGI-Spacer Precision

Explanation

The window U-values were calculated for the test window size of 1.23 m × 1.48 m with $U_g = 0.90$ W/(m² K).
 If a higher quality glazing is used, the window U-values will improve as follows:

Glazing	$U_g =$	0.90	0.80	0.70	0.64	W/(m ² K)
		↓	↓	↓	↓	
Window	$U_W =$	1.00	0.93	0.86	0.82	W/(m ² K)



Transparent building components are classified into efficiency classes depending on the heat losses through the opaque part. The frame U-Values, frame widths, thermal bridges at the glazing edge, and the glazing edge lengths are included in these heat losses. A more detailed report of the calculations performed in the context of certification is available from the manufacturer.

The Passive House Institute has defined international component criteria for seven climate zones. In principle, components which have been certified for climate zones with higher requirements may also be used in climates with less stringent requirements. In a particular climate zone it may make sense to use a component of a higher thermal quality which has been certified for a climate zone with more stringent requirements.

Further information relating to certification can be found on www.passivehouse.com and passipedia.org.

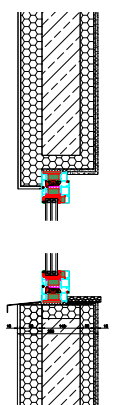
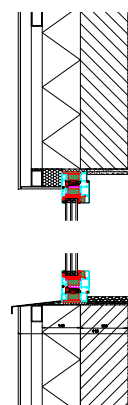
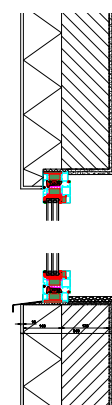
Validated installations

Formwork blocks (operable)		Ventilated facade		Exterior insulation and finishing system (EIFS) (operable)	
$U_{Wall} = 0.25 \text{ W}/(\text{m}^2 \text{ K})$		$U_{Wall} = 0.23 \text{ W}/(\text{m}^2 \text{ K})$		$U_{Wall} = 0.23 \text{ W}/(\text{m}^2 \text{ K})$	
					
$\Psi_{install}$	W/(m K)	$\Psi_{install}$	W/(m K)	$\Psi_{install}$	W/(m K)
Top	0.009	Top	0.010	Top	0.008
Side	0.009	Side	0.010	Side	0.008
Bottom	0.019	Bottom	0.017	Bottom	0.017
$U_{W,installed} = 1.03 \text{ W}/(\text{m}^2 \text{ K})$		$U_{W,installed} = 1.03 \text{ W}/(\text{m}^2 \text{ K})$		$U_{W,installed} = 1.03 \text{ W}/(\text{m}^2 \text{ K})$	

Frame values			Frame width	U-value frame	Ψ -glazing edge	Temp. Factor
			b_f	U_f	Ψ_g	$f_{Rsi=0.25}$
			mm	W/(m ² K)	W/(m K)	[-]
Flying Mulinion	(FM1)		138	0.99	0.028	0.70
Bottom	(OB1)		114	0.99	0.028	0.70
Top	(OH1)		114	0.99	0.028	0.70
Lateral	(OJ1)		114	0.99	0.028	0.70
Spacer: Technoform-Spacer SP16			Secondary seal: Polysulfide			

