

CERTIFICATE

Certified Passive House Component

Component-ID 1350wi04 valid until 31st December 2025

Passive House Institute
Dr. Wolfgang Feist
64283 Darmstadt
Germany

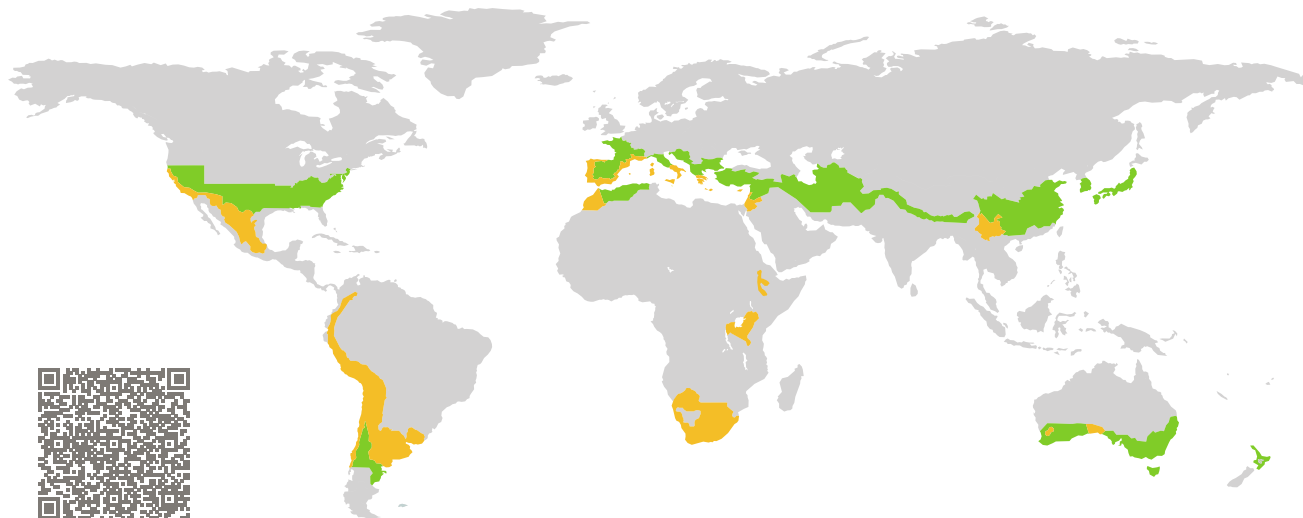

Category: **Window Frame**
Manufacturer: **Qingdao Faguo industry and Trade Co., Ltd., Qingdao, China**
Product name: **Faguo Aluminum window**

This certificate was awarded based on the following criteria for the warm, temperate climate zone

Comfort $U_W = 0.99 \leq 1.00 \text{ W}/(\text{m}^2 \text{ K})$
 $U_{W, \text{installed}} \leq 1.05 \text{ W}/(\text{m}^2 \text{ K})$
with $U_g = 0.90 \text{ W}/(\text{m}^2 \text{ K})$

Hygiene $f_{Rsi=0.25} \geq 0.65$

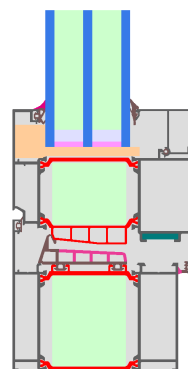

Passive House
efficiency class

phE

phD

phC

phB

phA

www.passivehouse.com

warm, temperate climate



phC

**CERTIFIED
COMPONENT**

Passive House Institute

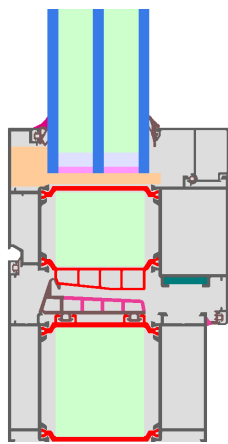

Calculation model

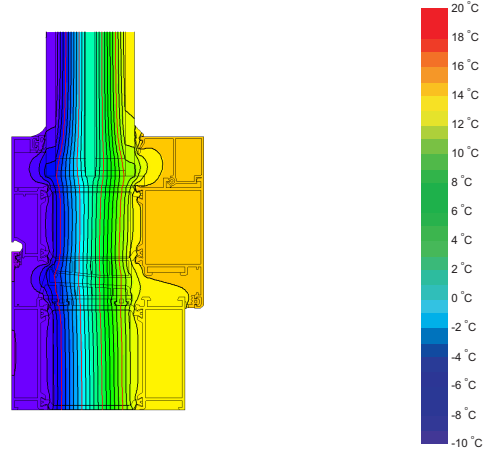

Isothermal

Description

Thermally separated aluminium frame with insulation (PU foam 0.028 W/(mK)); Pane thickness: 47 mm (5/16/5/16/5), rebate depth: 21 mm, spacer: SWISSPACER Ultimate

Explanation

The window U-values were calculated for the test window size of 1.23 m × 1.48 m with $U_g = 0.90$ W/(m² K). If a higher quality glazing is used, the window U-values will improve as follows:

Glazing	$U_g =$	0.90	0.80	0.70	0.60	W/(m ² K)
		↓	↓	↓	↓	
Window	$U_W =$	0.99	0.93	0.87	0.81	W/(m ² K)





Transparent building components are classified into efficiency classes depending on the heat losses through the opaque part. The frame U-Values, frame widths, thermal bridges at the glazing edge, and the glazing edge lengths are included in these heat losses. A more detailed report of the calculations performed in the context of certification is available from the manufacturer.

The Passive House Institute has defined international component criteria for seven climate zones. In principle, components which have been certified for climate zones with higher requirements may also be used in climates with less stringent requirements. In a particular climate zone it may make sense to use a component of a higher thermal quality which has been certified for a climate zone with more stringent requirements.

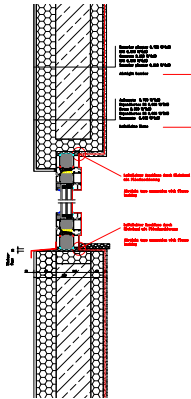
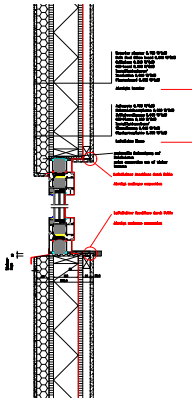
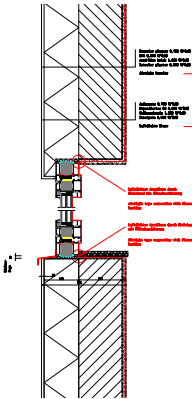
Further information relating to certification can be found on www.passivehouse.com and passipedia.org.

Validated installations

Formwork blocks (operable)	Lightweight timber (operable)	Exterior insulation and finishing system (EIFS) (operable)
$U_{\text{Wall}} = 0.25 \text{ W}/(\text{m}^2 \text{ K})$	$U_{\text{Wall}} = 0.21 \text{ W}/(\text{m}^2 \text{ K})$	$U_{\text{Wall}} = 0.23 \text{ W}/(\text{m}^2 \text{ K})$
		
Ψ_{install} W/(m K)	Ψ_{install} W/(m K)	Ψ_{install} W/(m K)
Top 0.010	Top 0.014	Top 0.005
Side 0.010	Side 0.014	Side 0.005
Bottom 0.021	Bottom 0.026	Bottom 0.015
$U_{W,\text{installed}} = 1.03 \text{ W}/(\text{m}^2 \text{ K})$	$U_{W,\text{installed}} = 1.04 \text{ W}/(\text{m}^2 \text{ K})$	$U_{W,\text{installed}} = 1.01 \text{ W}/(\text{m}^2 \text{ K})$

Frame values	Frame width b_f mm	U -value frame U_f W/(m ² K)	Ψ -glazing edge Ψ_g W/(m K)	Temp. Factor $f_{Rsi=0.25}$ [-]
Mullion 1 casement (1M1) 	148	1.02	0.028	0.74
Bottom (OB1) 	145	0.97	0.027	0.76
Top (OH1) 	145	0.97	0.027	0.76
Lateral (OJ1) 	145	0.97	0.027	0.76
Spacer: SWISSPACER Ultimate		Secondary seal: Polysulfide		

