

CERTIFICATE

Certified Passive House Component

Component-ID 1427wi04 valid until 31st December 2025

Passive House Institute
Dr. Wolfgang Feist
64283 Darmstadt
Germany

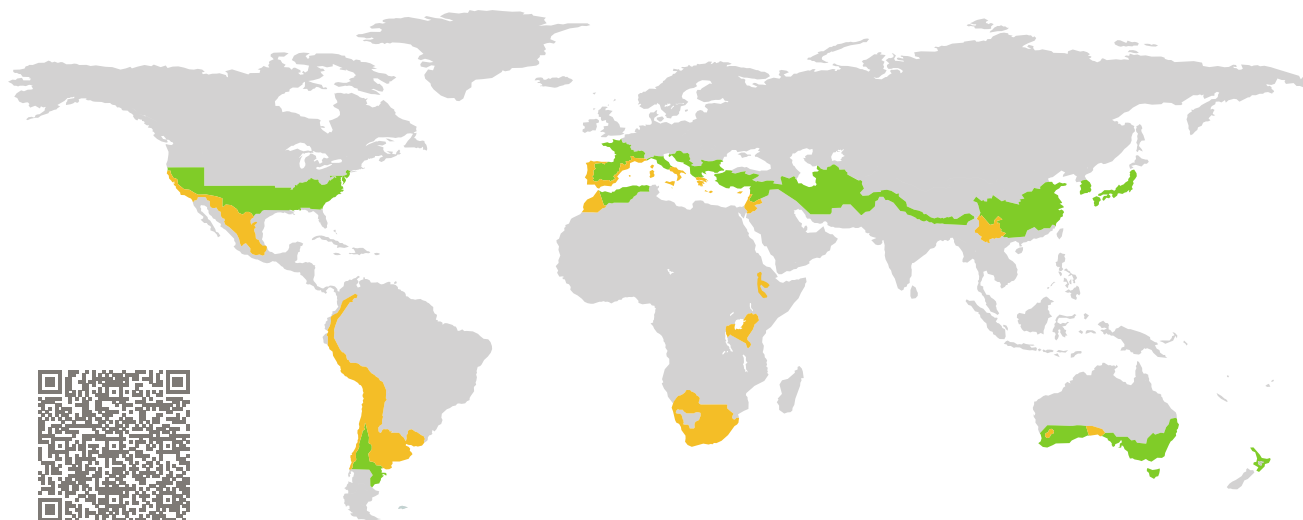

Category: **Window Frame**
Manufacturer: **Finstral AG,
Ritten,
Italy**
Product name: **FIN-Window Nova-line 90**

**This certificate was awarded based on the following
criteria for the warm, temperate climate zone**

Comfort $U_W = 1.00 \leq 1.00 \text{ W}/(\text{m}^2 \text{ K})$
 $U_{W, \text{installed}} \leq 1.05 \text{ W}/(\text{m}^2 \text{ K})$
with $U_g = 0.90 \text{ W}/(\text{m}^2 \text{ K})$

Hygiene $f_{Rsi=0.65} \geq 0.65$

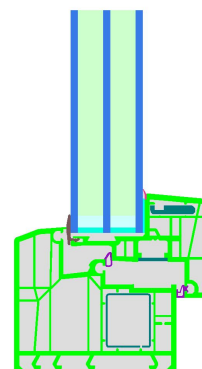

Passive House
efficiency class

phE

phD

phC

phB

phA

warm, temperate climate



**CERTIFIED
COMPONENT**

Passive House Institute

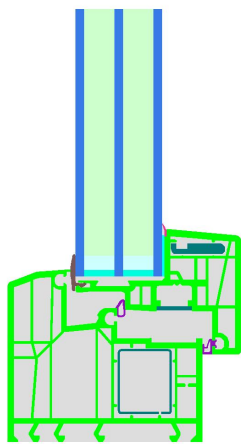

Calculation model

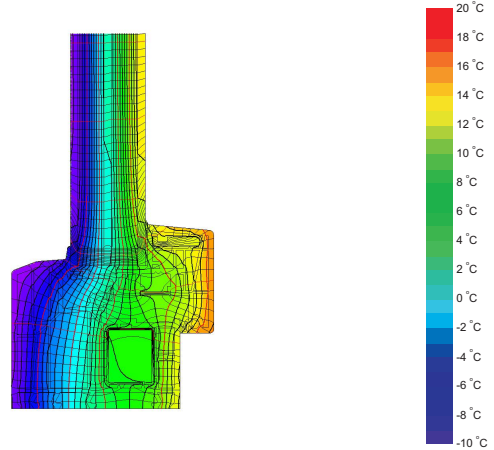

Isothermal

Description

PVC-U-window frame (PVC-U $\lambda=0,17$ W/mK). Glazing: 4/14/4/14/4 Pane thickness: 40 mm (4/14/4/14/4), rebate depth: 22 mm. Spacer: Swisspacer Advance with butyl as secondary seal.

Explanation

The window U-values were calculated for the test window size of 1.23 m × 1.48 m with $U_g = 0.90$ W/(m² K). If a higher quality glazing is used, the window U-values will improve as follows:

Glazing	$U_g =$	0.90	0.70	0.64	0.58	W/(m ² K)
		↓	↓	↓	↓	
Window	$U_W =$	1.00	0.86	0.82	0.77	W/(m ² K)





Transparent building components are classified into efficiency classes depending on the heat losses through the opaque part. The frame U-Values, frame widths, thermal bridges at the glazing edge, and the glazing edge lengths are included in these heat losses. A more detailed report of the calculations performed in the context of certification is available from the manufacturer.

The Passive House Institute has defined international component criteria for seven climate zones. In principle, components which have been certified for climate zones with higher requirements may also be used in climates with less stringent requirements. In a particular climate zone it may make sense to use a component of a higher thermal quality which has been certified for a climate zone with more stringent requirements.

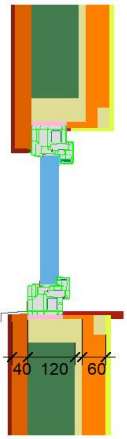
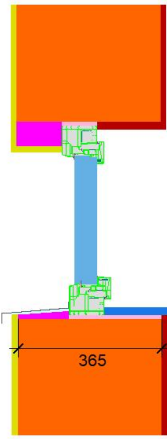
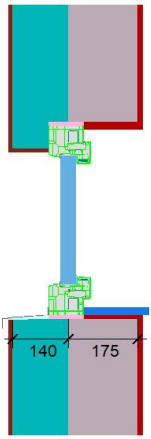
Further information relating to certification can be found on www.passivehouse.com and passipedia.org.

Validated installations

Lightweight timber (operable)	Monolithic construction (operable)	Exterior insulation and finishing system (EIFS) (operable)
$U_{Wall} = 0.19 \text{ W}/(\text{m}^2 \text{ K})$	$U_{Wall} = 0.23 \text{ W}/(\text{m}^2 \text{ K})$	$U_{Wall} = 0.23 \text{ W}/(\text{m}^2 \text{ K})$
		
$\Psi_{install}$ W/(m K)	$\Psi_{install}$ W/(m K)	$\Psi_{install}$ W/(m K)
Top 0.007	Top 0.004	Top -0.003
Side 0.007	Side 0.004	Side -0.003
Bottom 0.022	Bottom 0.016	Bottom 0.027
$U_{W,installed} = 1.04 \text{ W}/(\text{m}^2 \text{ K})$	$U_{W,installed} = 1.03 \text{ W}/(\text{m}^2 \text{ K})$	$U_{W,installed} = 1.02 \text{ W}/(\text{m}^2 \text{ K})$

Frame values		Frame width b_f mm	U -value frame U_f W/(m ² K)	Ψ -glazing edge Ψ_g W/(m K)	Temp. Factor $f_{Rsi=0.65}$ [-]
Flying Mullion (FM1)		121	1.26	0.032	0.66
Bottom (OB1)		99	0.98	0.033	0.71
Top (OH1)		99	0.98	0.033	0.71
Lateral (OJ1)		99	0.98	0.033	0.71
Spacer: SWISSPACER Advance			Secondary seal: Butyl		

