

CERTIFICATE

Certified Passive House Component

Component-ID 2195wi03 valid until 31st December 2025

Passive House Institute
Dr. Wolfgang Feist
64283 Darmstadt
Germany

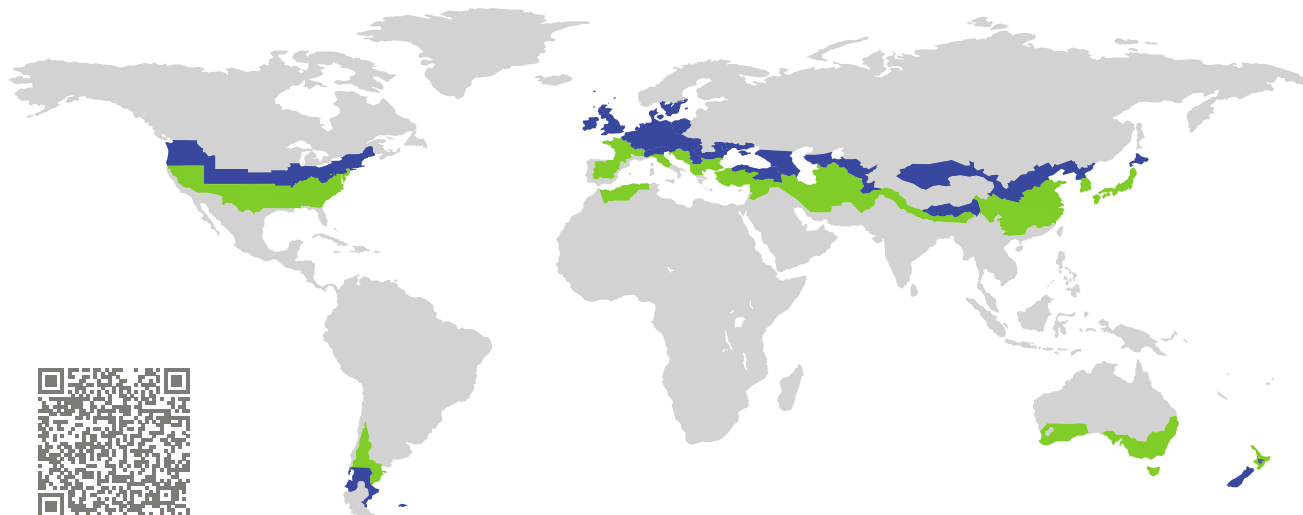

Category: **Window Frame**
Manufacturer: **Aluxil GmbH,
Düsseldorf,
Germany**
Product name: **TH-95**

**This certificate was awarded based on the following
criteria for the cool, temperate climate zone**

Comfort $U_W = 0.80 \leq 0.80 \text{ W}/(\text{m}^2 \text{ K})$
 $U_{W, \text{installed}} \leq 0.85 \text{ W}/(\text{m}^2 \text{ K})$
with $U_g = 0.70 \text{ W}/(\text{m}^2 \text{ K})$

Hygiene $f_{Rsi=0.25} \geq 0.70$

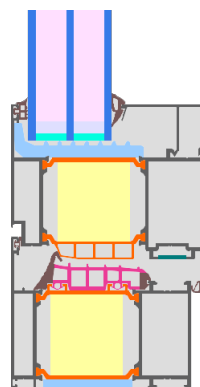

Passive House
efficiency class

phE

phD

phC

phB

phA

www.passivehouse.com

cool, temperate climate



**CERTIFIED
COMPONENT**

Passive House Institute

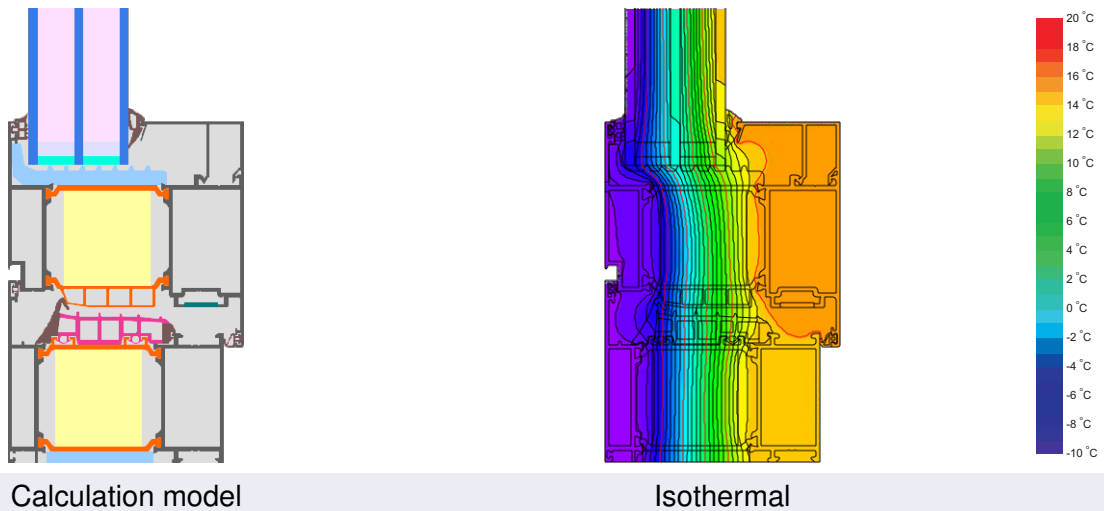

Calculation model Isothermal

Description

Aluminium frame with thermal separation (Technoform Low Lambda PA 0.21 W/(mK)) and insulation (Kooltherm 0.022 W/(mK)); pane thickness: 44 mm (4/16/4/16/4); rebate depth: 19 mm. Spacer: Technoform SP16 with butyl secondary seal.

Explanation

The window U-values were calculated for the test window size of 1.23 m × 1.48 m with $U_g = 0.70 \text{ W}/(\text{m}^2 \text{ K})$. If a higher quality glazing is used, the window U-values will improve as follows:

Glazing	$U_g =$	0.70	0.64	0.58	0.52	W/(m ² K)
		↓	↓	↓	↓	
Window	$U_W =$	0.80	0.76	0.72	0.69	W/(m ² K)





Transparent building components are classified into efficiency classes depending on the heat losses through the opaque part. The frame U-Values, frame widths, thermal bridges at the glazing edge, and the glazing edge lengths are included in these heat losses. A more detailed report of the calculations performed in the context of certification is available from the manufacturer.

The Passive House Institute has defined international component criteria for seven climate zones. In principle, components which have been certified for climate zones with higher requirements may also be used in climates with less stringent requirements. In a particular climate zone it may make sense to use a component of a higher thermal quality which has been certified for a climate zone with more stringent requirements.

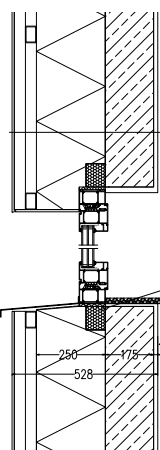
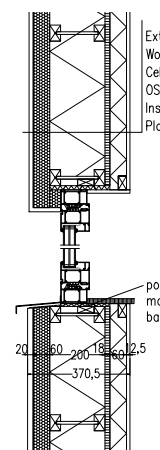
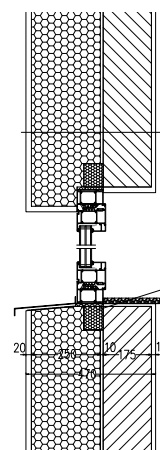
Further information relating to certification can be found on www.passivehouse.com and passipedia.org.

Validated installations

Ventilated facade (operable)		Lightweight timber (operable)		Exterior insulation and finishing system (EIFS) (operable)	
$U_{Wall} = 0.13 \text{ W}/(\text{m}^2 \text{ K})$		$U_{Wall} = 0.13 \text{ W}/(\text{m}^2 \text{ K})$		$U_{Wall} = 0.13 \text{ W}/(\text{m}^2 \text{ K})$	
 <p>Ventilated facade – substructure Mineral wool 0.035 W/(mK) Concrete 2.3 W/(mK) Interior plaster 0.57 W/(mK)</p>		 <p>Exterior plaster 1.0 W/(mK) Wood fibre board 0.050 W/(mK) Cellulose 0.040 W/(mK) OSB-board 0.13 W/(mK) Insulation 0.040 W/(mK) Plasterboard 0.25 W/(mK)</p>		 <p>Exterior plaster 1.0 W/(mK) EPS 0.035 W/(mK) Adhesive 0.70 W/(mK) Sand-lime brick 1.0 W/(mK) Interior plaster 0.57 W/(mK)</p>	
Suitable fastening, e.g. mounting frame or bracket, but only protruding as far as necessary for fixing the window		point connection made from timber battens		Suitable fastening, e.g. mounting frame or bracket, but only protruding as far as necessary for fixing the window	
$\Psi_{install}$	W/(m K)	$\Psi_{install}$	W/(m K)	$\Psi_{install}$	W/(m K)
Top	0.016	Top	0.016	Top	0.017
Side	0.016	Side	0.016	Side	0.017
Bottom	0.025	Bottom	0.023	Bottom	0.025
$U_{W, installed} = 0.85 \text{ W}/(\text{m}^2 \text{ K})$		$U_{W, installed} = 0.85 \text{ W}/(\text{m}^2 \text{ K})$		$U_{W, installed} = 0.85 \text{ W}/(\text{m}^2 \text{ K})$	

Frame values		Frame width b_f mm	U -value frame U_f W/(m ² K)	Ψ -glazing edge Ψ_g W/(m K)	Temp. Factor $f_{Rsi=0.25}$ [-]
Flying Mullion (FM1)		207	0.86	0.026	0.78
Bottom (OB1)		150	0.79	0.026	0.78
Top (OH1)		150	0.79	0.026	0.78
Lateral (OJ1)		150	0.79	0.026	0.78
Spacer: Technoform-Spacer SP16		Secondary seal: Butyl			

