

CERTIFICATE

Certified Passive House Component

Component-ID 0394sk03 valid until 31st December 2025

Passive House Institute
Dr. Wolfgang Feist
64283 Darmstadt
Germany

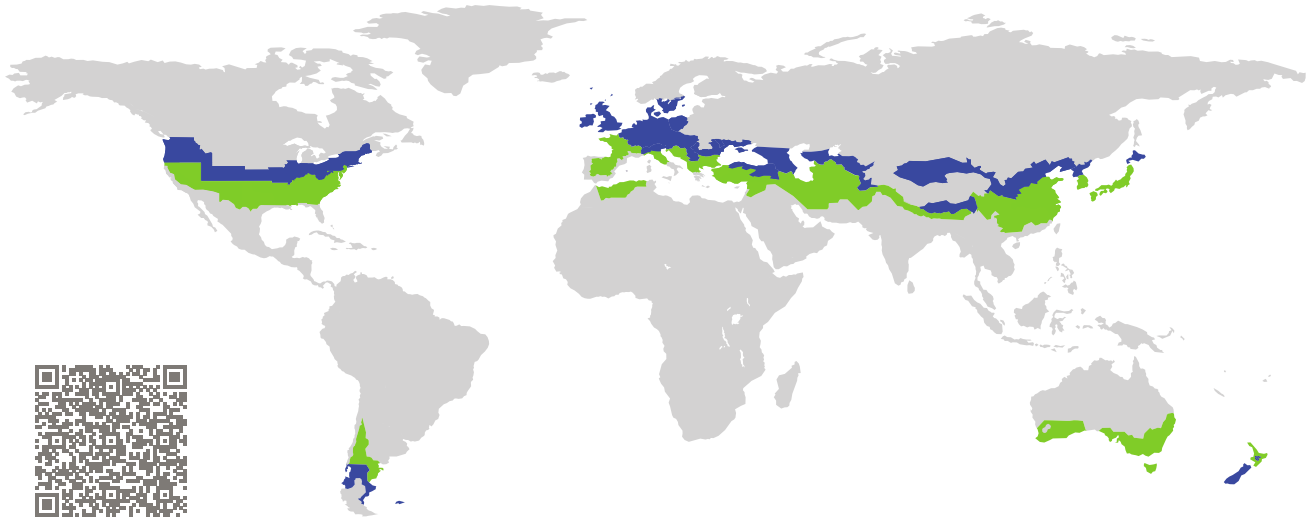

Category: **Skylight**
Manufacturer: **Hans Börner GmbH & Co. KG,
Nauheim,
Germany**
Product name: **Nauheimer Lichtkuppel**

**This certificate was awarded based on the following
criteria for the cool, temperate climate zone**

Comfort $U_{SK} = 0.68 \leq 1.10 \text{ W}/(\text{m}^2 \text{ K})$
 $U_{SK, \text{installed}} \leq 1.10 \text{ W}/(\text{m}^2 \text{ K})$
with $U_g = 0.89 \text{ W}/(\text{m}^2 \text{ K})$

Hygiene $f_{Rsi=0.25} \geq 0.70$

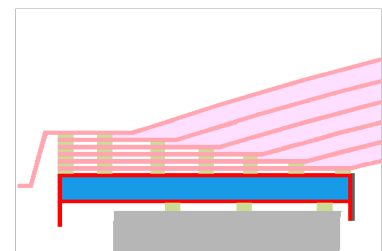

cool, temperate climate



**CERTIFIED
COMPONENT**

Passive House Institute

Passive House
efficiency class

phE

phD

phC

phB

phA

www.passivehouse.com

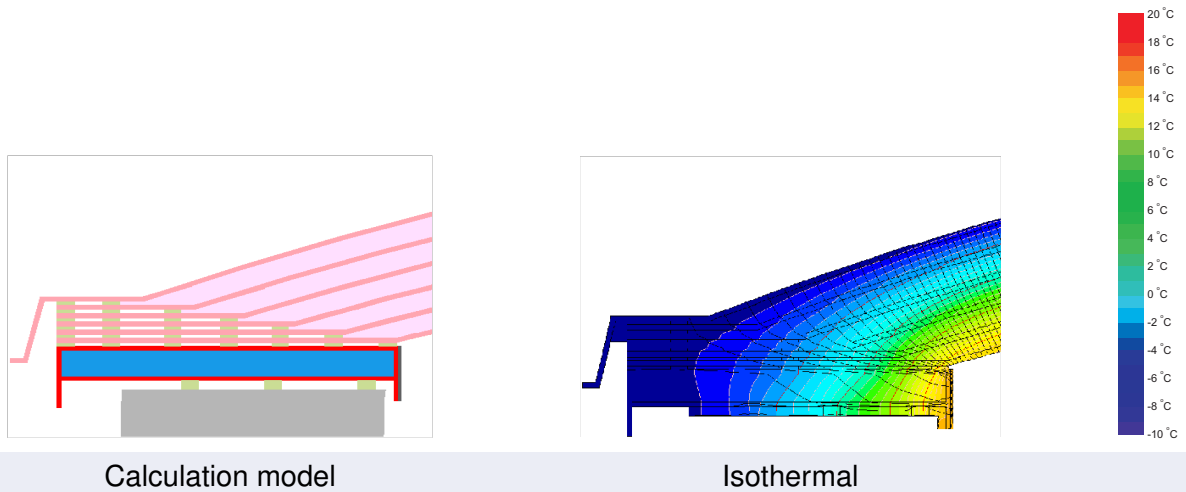

Description

Openabel PU-foam insulated sash with 6-shell acryldome, height 87,2 mm. The gaps of the shell are filled with air. The shells are uncoated. Pane thickness: 93 mm.

Explanation



The window U-values were calculated for the test window size of 1.50 m × 1.50 m with $U_g = 0.89 \text{ W}/(\text{m}^2 \text{ K})$. If a higher quality glazing is used, the window U-values will improve as follows:

Glazing	$U_g =$	0.89	0.92	1.00	1.10	$\text{W}/(\text{m}^2 \text{ K})$
		↓	↓	↓	↓	
Window	$U_W =$	0.68	0.69	0.74	0.79	$\text{W}/(\text{m}^2 \text{ K})$

Transparent building components are classified into efficiency classes depending on the heat losses through the opaque part. The frame U-Values, frame widths, thermal bridges at the glazing edge, and the glazing edge lengths are included in these heat losses. A more detailed report of the calculations performed in the context of certification is available from the manufacturer.

The Passive House Institute has defined international component criteria for seven climate zones. In principle, components which have been certified for climate zones with higher requirements may also be used in climates with less stringent requirements. In a particular climate zone it may make sense to use a component of a higher thermal quality which has been certified for a climate zone with more stringent requirements.

Further information relating to certification can be found on www.passivehouse.com and passipedia.org.

Frame values		Frame width b_f mm	U-value frame U_f $\text{W}/(\text{m}^2 \text{ K})$	ψ -glazing edge ψ_g $\text{W}/(\text{m K})$	Temp. Factor $f_{Rsi=0.25}$ [-]
Bottom	(OB1) 	201	0.29	0.034	0.71
Top	(OH1) 	201	0.29	0.034	0.71
Lateral	(OJ1) 	201	0.29	0.034	0.71
Spacer: -			Secondary seal: -		

Validated installations

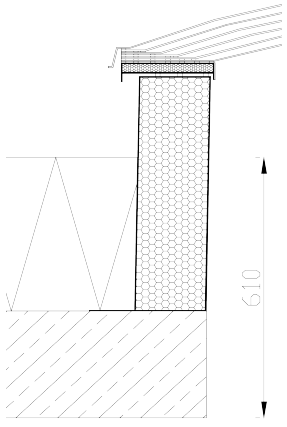
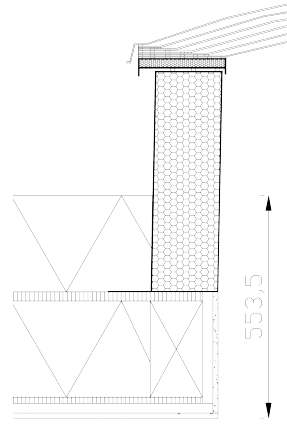
Concrete roof		Lightweight roof	
$U_{\text{Wall}} = 0.10 \text{ W}/(\text{m}^2 \text{ K})$		$U_{\text{Wall}} = 0.08 \text{ W}/(\text{m}^2 \text{ K})$	
			
Ψ_{install}	W/(m K)	Ψ_{install}	W/(m K)
Top	0.034	Top	0.064
Left	0.034	Left	0.064
Right	0.034	Right	0.064
Bottom	0.034	Bottom	0.064
$U_{W,\text{installed}} = 0.77 \text{ W}/(\text{m}^2 \text{ K})$		$U_{W,\text{installed}} = 0.85 \text{ W}/(\text{m}^2 \text{ K})$	

