

# CERTIFICATE

Certified Passive House Component

Component-ID 1388ed03 valid until 31st December 2021

Passive House Institute  
Dr. Wolfgang Feist  
64283 Darmstadt  
Germany

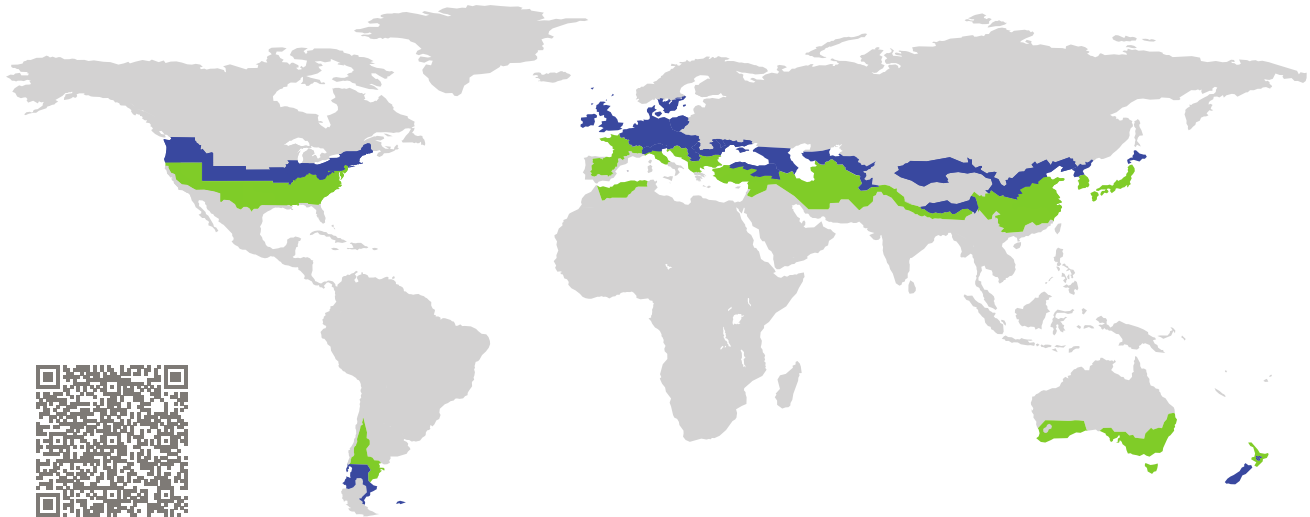

Category: **Entry door**  
Manufacturer: **Harbin Sayyas Windows Stock Co. Ltd.**  
**Wanggang Town Nangang Distr.**  
**Harbin**  
**China**  
Product name: **PASSIVE 120C-108e**

**This certificate was awarded based on the following criteria for the cool, temperate climate zone**

Comfort  $U_D = 0.77 \leq 0.80 \text{ W}/(\text{m}^2 \text{ K})$   
 $U_{D,\text{installed}} \leq 0.85 \text{ W}/(\text{m}^2 \text{ K})$   
with  $U_g^1 = 0.60 \text{ W}/(\text{m}^2 \text{ K})$

Hygiene  $f_{Rsi=0.25} \geq 0.70$

<sup>1</sup>Fully glazed door

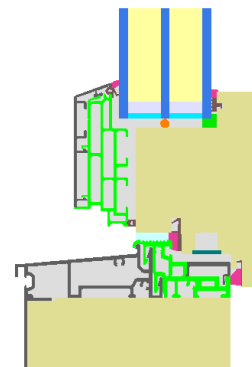

(Inward opening)

cool, temperate climate



**CERTIFIED COMPONENT**

Passive House Institute

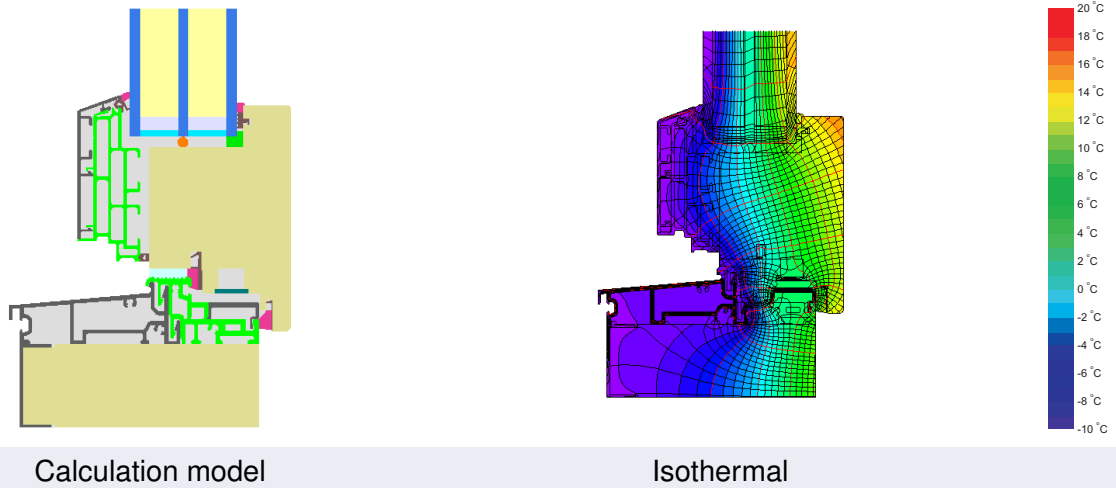

## Description

Fully glazed door with timber-aluminium frame, insulated by EPS-foam (0.032 W/(mK)). Thermal characteristics determined with  $U_g = 0,60 \text{ W}/(\text{m}^2\text{K})$ . The temperature factor is not achieved at the threshold. Pane thickness: 51 mm (5/18/5/18/5), rebate depth: 15 mm. Spacer: SWISSPACER Ultimate with polyurethane as secondary seal.

## Explanation





The U-values of the door apply to a door 1.10 m wide by 2.20 m tall.

A detailed report of the calculations performed in the context of certification is available from the manufacturer.

Unless stated otherwise, the air tightness was determined according to EN 1026 with respect to the joint length under climate load in conjunction with EN 1121 for the closed, non-locked door. The result corresponds at least to air-tightness class 3 according to EN 12207.

The Passive House Institute has defined international component criteria for seven climate zones. In principle, components which have been certified for climate zones with higher requirements may also be used in climates with less stringent requirements. In a particular climate zone it may make sense to use a component of a higher thermal quality which has been certified for a climate zone with more stringent requirements.

Further information relating to certification can be found on [www.passivehouse.com](http://www.passivehouse.com) and [passipedia.org](http://passipedia.org).

Frame values		Frame width $b_f$ mm	$U$ -value frame $U_f$ W/(m <sup>2</sup> K)	$\Psi$ edge $\Psi_g$ W/(m K)	Temp. Factor $f_{Rsi=0.25}$ [-]
Top	(to) 	155	0.80	0.022	0.77
Threshold	(th) 	159	1.48	0.020	0.55
Hinge side door	(hs) 	155	0.80	0.022	0.77
Lock side Door	(ls) 	155	0.80	0.022	0.77
Spacer: SWISSPACER Ultimate			Secondary seal: Polysulfid		

 Top

$b_f = 155.00 \text{ mm}$   
 $U_f = 0.80 \text{ W/(m}^2 \text{ K)}$   
 $\Psi_g = 0.022 \text{ W/(m K)}$   
 $f_{Rsi} = 0.77$



 Threshold

$b_f = 159.00 \text{ mm}$   
 $U_f = 1.48 \text{ W/(m}^2 \text{ K)}$   
 $\Psi_g = 0.020 \text{ W/(m K)}$   
 $f_{Rsi} = 0.55$



 Hinge side  
door

$b_f = 155.00 \text{ mm}$   
 $U_f = 0.80 \text{ W/(m}^2 \text{ K)}$   
 $\Psi_g = 0.022 \text{ W/(m K)}$   
 $f_{Rsi} = 0.77$



 Lock side  
Door

$b_f = 155.00 \text{ mm}$   
 $U_f = 0.80 \text{ W/(m}^2 \text{ K)}$   
 $\Psi_g = 0.022 \text{ W/(m K)}$   
 $f_{Rsi} = 0.77$



Formwork blocks top (operable)

$$U_1 = 0.15 \text{ [W/(m}^2 \text{ K)]}$$

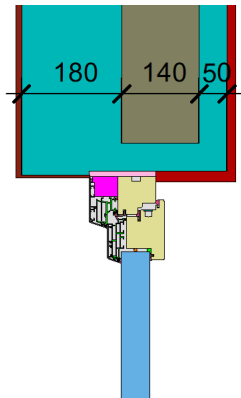

$$\Psi_{\text{install}} = 0.013 \text{ W/(m K)}$$

Lightweight timber top (operable)

$$U_1 = 0.13 \text{ [W/(m}^2 \text{ K)]}$$

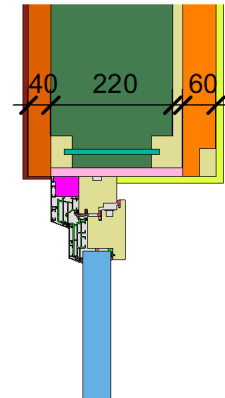

$$\Psi_{\text{install}} = 0.018 \text{ W/(m K)}$$

Exterior insulation and finishing s (EIFS) top (operable)

$$U_1 = 0.15 \text{ [W/(m}^2 \text{ K)]}$$

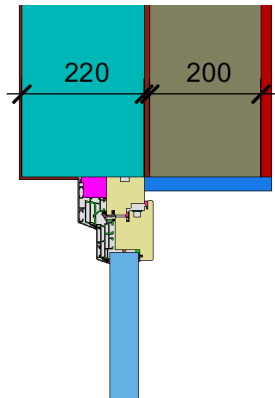

$$\Psi_{\text{install}} = 0.010 \text{ W/(m K)}$$

Ext insulation a. finish. s. (EIFS) threshold ceiling (operable)

$$U_1 = 0.15 \text{ [W/(m}^2 \text{ K)]}$$

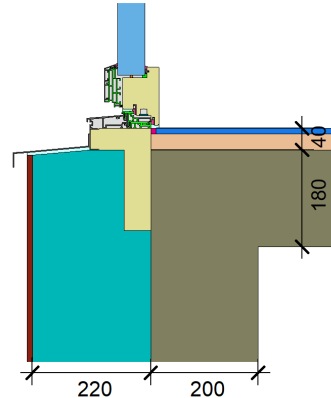

$$\Psi_{\text{install}} = 0.045 \text{ W/(m K)}$$

