

CERTIFICATE

Certified Passive House Component

Component-ID 1732ed03 valid until 31st December 2025

Passive House Institute
Dr. Wolfgang Feist
64283 Darmstadt
Germany

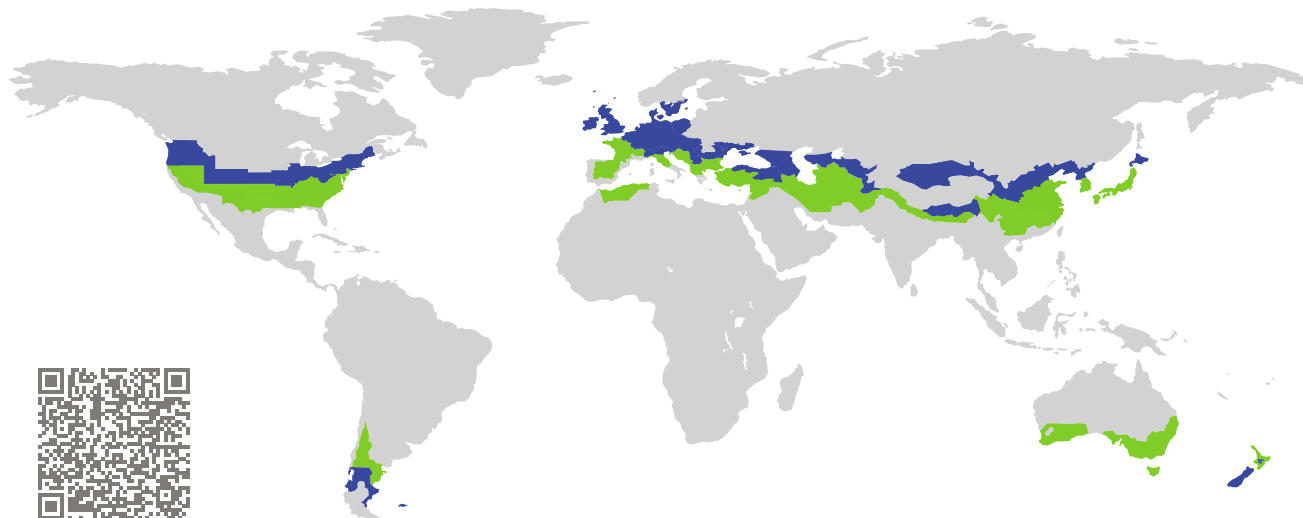

Category: **Entry door(opaque)**
Manufacturer: **SC Danprod SRL**
Targu Ocna
Romania
Product name: **Husky Clima 93**

This certificate was awarded based on the following criteria for the cool, temperate climate zone

Comfort $U_D = 0.80 \leq 0.80 \text{ W}/(\text{m}^2 \text{ K})$
 $U_{D, \text{installed}} \leq 0.85 \text{ W}/(\text{m}^2 \text{ K})$
with $U_{\text{door leaf}}^1 = 0.43 \text{ W}/(\text{m}^2 \text{ K})$

Hygiene $f_{Rsi=0.25} \geq 0.70$
Airtightness $Q_{100} = 0.9 \leq 2.25 \text{ m}^3/(\text{h m})$

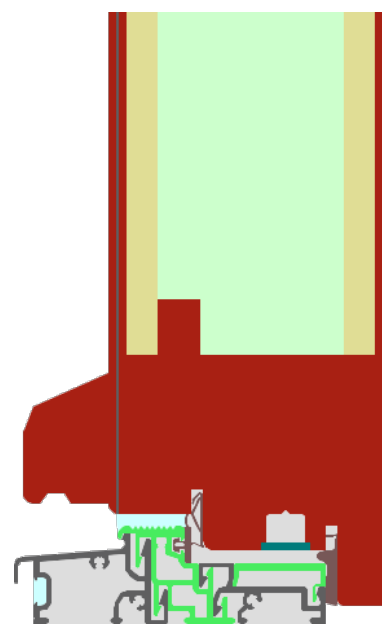

(Inward opening)

¹U-value of the insulated area of door leaf

cool, temperate climate



**CERTIFIED
COMPONENT**

Passive House Institute

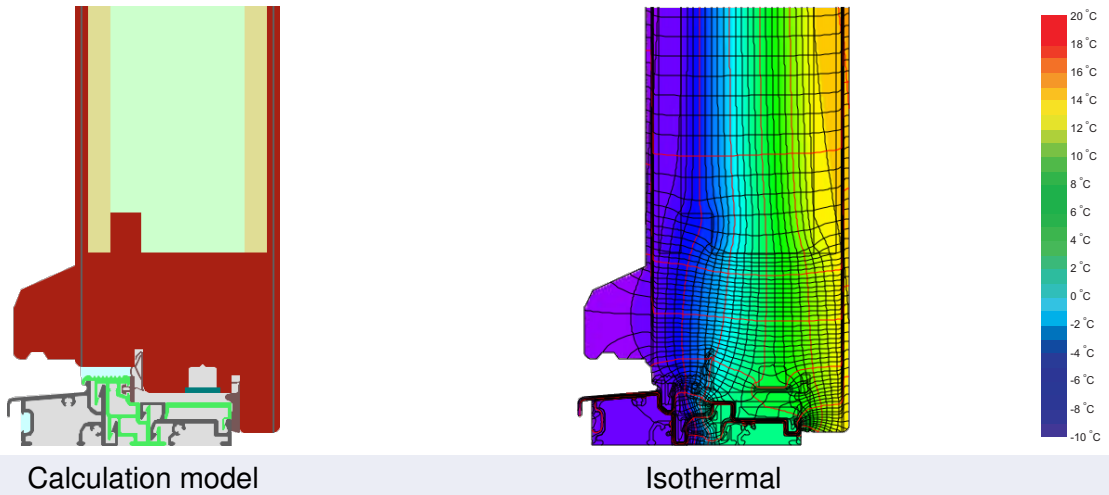

Description

Timber doorset (oak / hardwood $0,18 \text{ W}/(\text{mK})$, $700 \text{ kg}/\text{m}^3$) insulated with BACHL PIR insulation ($0,031 \text{ W}/(\text{mK})$), frame insulated with Compacfoam 100 ($0,040 \text{ W}/(\text{mK})$). The required temperature factor at the threshold is met in the door's installed state. Beyond the requirements, airtightness class 4 according to EN 12207 is met. The requirement is greatly exceeded due to the use of the locking mechanism Security Automatic MR4-65/92/10/20/10 from GU Germany, which engages all locking points automatically on closing.

Explanation

The U-values of the door apply to a door 1.10 m wide by 2.20 m tall.

A detailed report of the calculations performed in the context of certification is available from the manufacturer.

Unless stated otherwise, the air tightness was determined according to EN 1026 with respect to the joint length under climate load in conjunction with EN 1121 for the closed, non-locked door. The result corresponds at least to air-tightness class 3 according to EN 12207.

The Passive House Institute has defined international component criteria for seven climate zones. In principle, components which have been certified for climate zones with higher requirements may also be used in climates with less stringent requirements. In a particular climate zone it may make sense to use a component of a higher thermal quality which has been certified for a climate zone with more stringent requirements.

Further information relating to certification can be found on www.passivehouse.com and passipedia.org.

Frame values		Frame width b_f mm	U -value frame U_f W/(m ² K)	Ψ edge Ψ_g W/(m K)	Temp. Factor $f_{Rsi=0.25}$ [-]
Door hinge side	(DJ1) 	126	1.32	0.013	0.72
Door lock side	(DL1) 	171	1.40	0.015	0.71
Top	(OH1) 	126	1.34	0.013	0.72
Threshold	(OT2) 	88	2.01	0.017	0.63
		Spacer:	Secondary seal:		



Door hinge side

$b_f = 126 \text{ mm}$
 $U_f = 1.32 \text{ W/(m}^2 \text{ K)}$
 $\Psi_g = 0.013 \text{ W/(m K)}$
 $f_{Rsi} = 0.72$

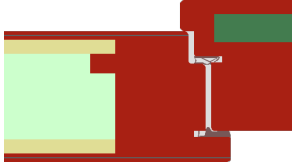

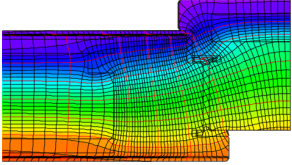





Door lock side

$b_f = 171 \text{ mm}$
 $U_f = 1.40 \text{ W/(m}^2 \text{ K)}$
 $\Psi_g = 0.015 \text{ W/(m K)}$
 $f_{Rsi} = 0.71$

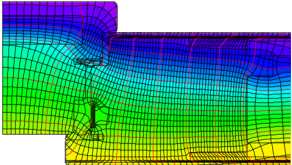





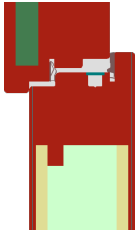

Top

$b_f = 126 \text{ mm}$
 $U_f = 1.34 \text{ W/(m}^2 \text{ K)}$
 $\Psi_g = 0.013 \text{ W/(m K)}$
 $f_{Rsi} = 0.72$

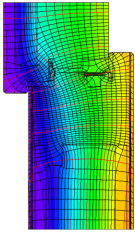





Threshold

$b_f = 88 \text{ mm}$
 $U_f = 2.01 \text{ W/(m}^2 \text{ K)}$
 $\Psi_g = 0.017 \text{ W/(m K)}$
 $f_{Rsi} = 0.63$

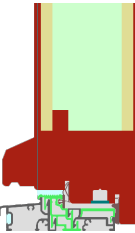

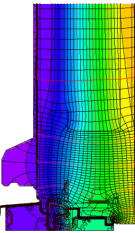

Validated installations

Formwork blocks top (operable)

$U_1 = 0.15 \text{ [W/(m}^2 \text{ K)]}$

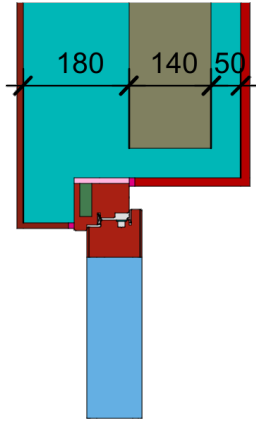

$\Psi_{\text{install}} = -0.00 \text{ W/(m K)}$

Formwork blocks side (operable)

$U_1 = 0.15 \text{ [W/(m}^2 \text{ K)]}$

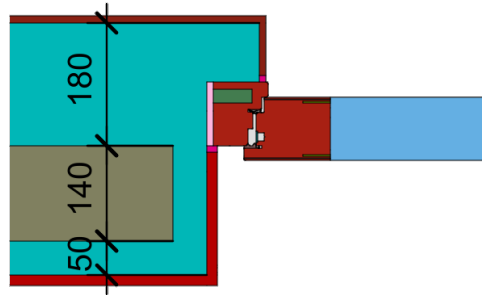

$\Psi_{\text{install}} = -0.00 \text{ W/(m K)}$

Formwork blocks side (operable)

$U_1 = 0.15 \text{ [W/(m}^2 \text{ K)]}$

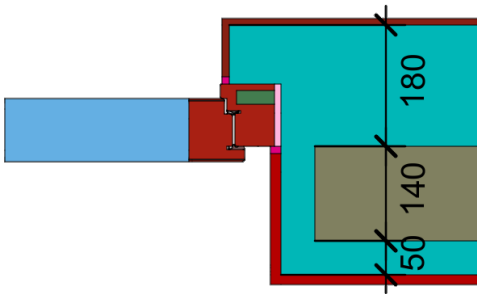

$\Psi_{\text{install}} = -0.00 \text{ W/(m K)}$

Lightweight timber top (operable)

$U_1 = 0.13 \text{ [W/(m}^2 \text{ K)]}$

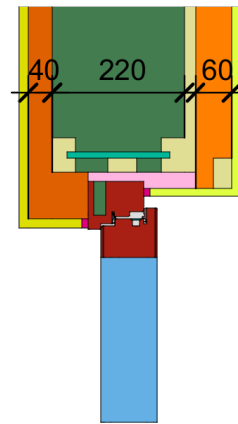

$\Psi_{\text{install}} = 0.00 \text{ W/(m K)}$

Lightweight timber side (operable)

$U_1 = 0.13 \text{ [W/(m}^2 \text{ K)]}$

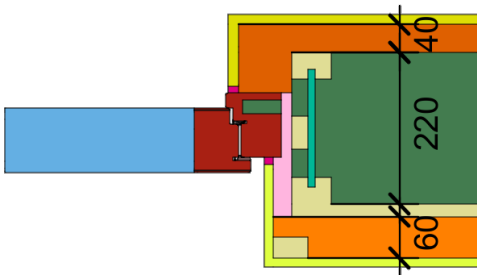

$\Psi_{\text{install}} = 0.00 \text{ W/(m K)}$

Lightweight timber side (operable)

$U_1 = 0.13 \text{ [W/(m}^2 \text{ K)]}$

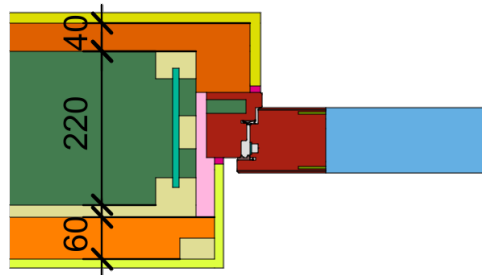

$\Psi_{\text{install}} = 0.00 \text{ W/(m K)}$

Exterior insulation and finishing s (EIFS)
top (operable)

$$U_1 = 0.13 \text{ [W/(m}^2 \text{ K)]}$$

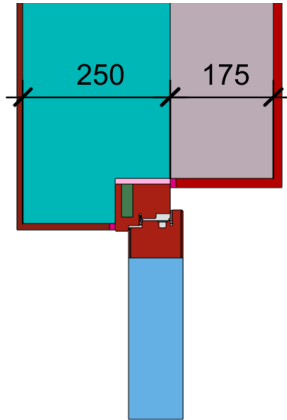

$$\Psi_{\text{install}} = -0.00 \text{ W/(m K)}$$

Ext. ins. a. finish. s. (EIFS) threshold
floor slab (operable)

$$U_1 = 0.13 \quad U_2 = 0.14 \text{ [W/(m}^2 \text{ K)]}$$

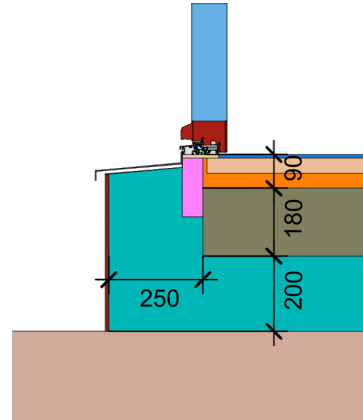

$$\Psi_{\text{install}} = 0.11 \text{ W/(m K)}$$

Ext insulation a. finish. s. (EIFS)
threshold ceiling (operable)

$$U_1 = 0.14 \text{ [W/(m}^2 \text{ K)]}$$

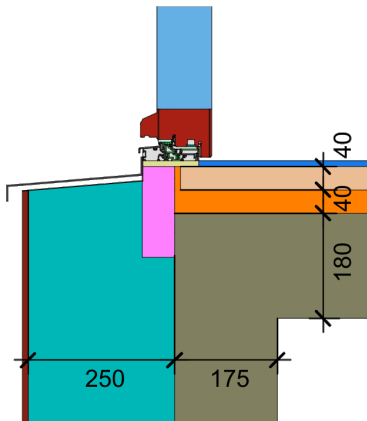

$$\Psi_{\text{install}} = 0.14 \text{ W/(m K)}$$

Exterior insulation and finishing s (EIFS)
threshold (operable)

$$U_1 = 0.13 \quad U_2 = 0.12 \text{ [W/(m}^2 \text{ K)]}$$

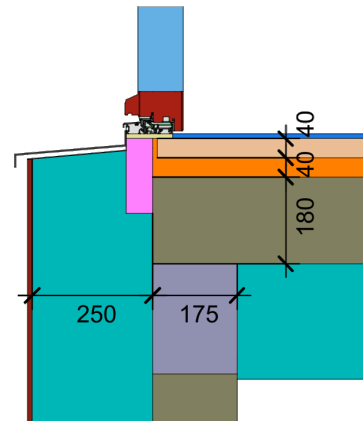

$$\Psi_{\text{install}} = 0.09 \text{ W/(m K)}$$

Exterior insulation and finishing system
(EIFS) side (operable)

$$U_1 = 0.13 \text{ [W/(m}^2 \text{ K)]}$$

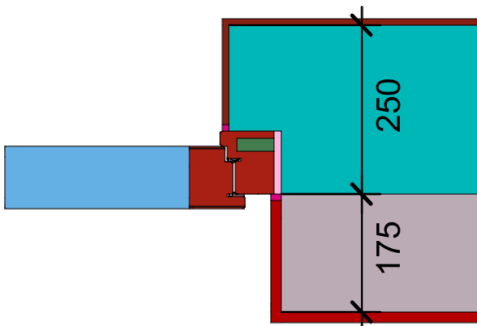

$$\Psi_{\text{install}} = -0.00 \text{ W/(m K)}$$

Exterior insulation and finishing system
(EIFS) side (operable)

$$U_1 = 0.13 \text{ [W/(m}^2 \text{ K)]}$$

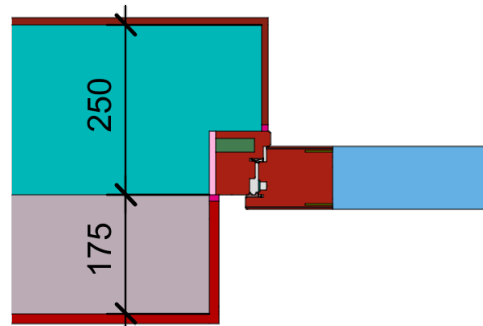

$$\Psi_{\text{install}} = -0.00 \text{ W/(m K)}$$

