

CERTIFICATE

Certified Passive House Component

Component-ID 2073ws04 valid until 31st December 2025

Passive House Institute
Dr. Wolfgang Feist
64283 Darmstadt
Germany

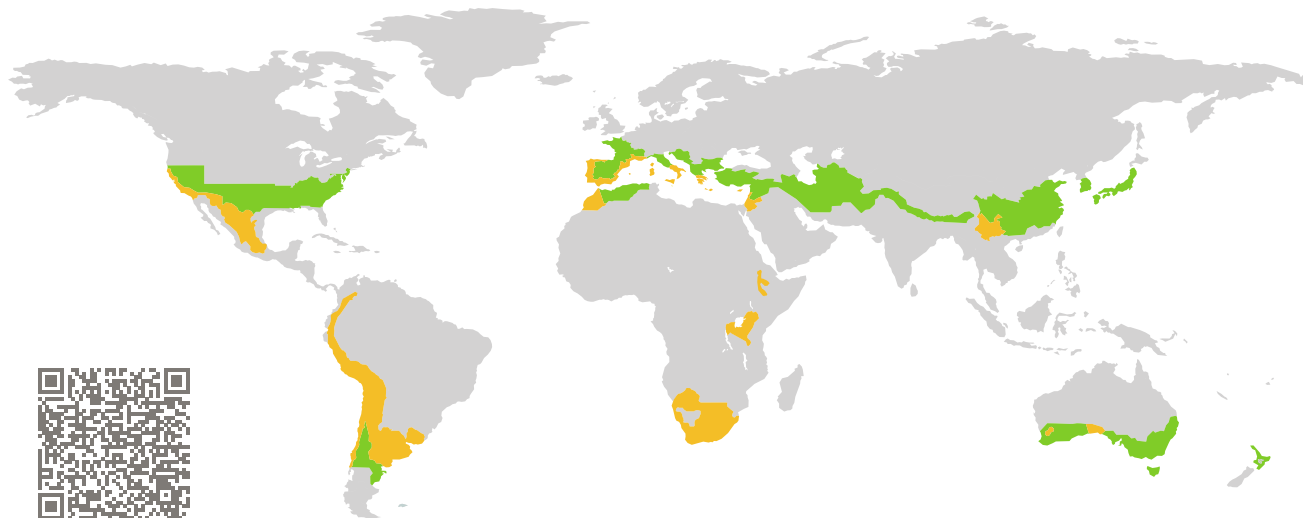

Category: **Window system**
Manufacturer: **Alphacan SRL,
Arco,
Italy**
Product name: **Alpha Extreme**

**This certificate was awarded based on the following
criteria for the warm, temperate climate zone**

Comfort $U_W = 0.99 \leq 1.00 \text{ W}/(\text{m}^2 \text{ K})$
 $U_{W, \text{installed}}$ $\leq 1.05 \text{ W}/(\text{m}^2 \text{ K})$
with $U_g = 0.90 \text{ W}/(\text{m}^2 \text{ K})$

Hygiene $f_{Rsi=0.25} \geq 0.65$
Airtightness $Q_{100} = 0.18 \leq 0.25 \text{ m}^3/(\text{h m})$



warm, temperate climate



**CERTIFIED
COMPONENT**

Passive House Institute

Passive House
efficiency class

phE

phD

phC

phB

phA

www.passivehouse.com

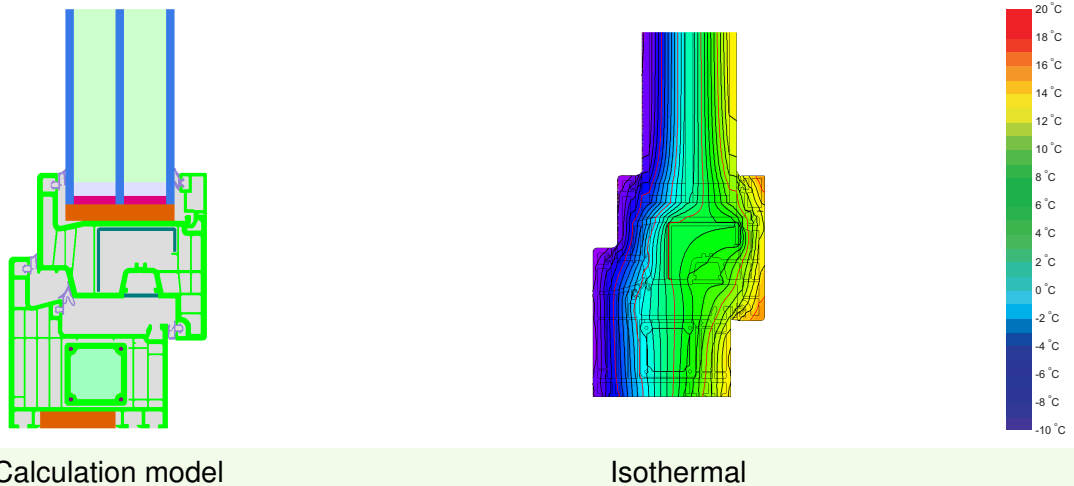

Calculation model Isothermal

Description

Multi-chamber PVC window system reinforced with steel in the sash and with uPVC filled with PVC foam [0.050 W/(mK)] in the frame. The glass rebate and installation gap are insulated with PE foam [0.045 W/(mK)]. Maximum dimensions: 1800 x 2400 mm. The required temperature factor is not achieved at the threshold. Pane thickness: 52 mm (4/20/4/20/4), rebate depth: 15 mm. Spacer: SWISSPACER Ultimate with silicone secondary seal.

Explanation

The window U-values were calculated for the test window size of 2.46 m × 1.48 m with $U_g = 0.90 \text{ W}/(\text{m}^2 \text{ K})$. If a higher quality glazing is used, the window U-values will improve as follows:

Glazing	$U_g =$	0.90	0.72	0.66	0.58	W/(m ² K)
		↓	↓	↓	↓	
Window	$U_w =$	0.99	0.86	0.82	0.76	W/(m ² K)

Transparent building components are classified into efficiency classes depending on the heat losses through the opaque part. The frame U-Values, frame widths, thermal bridges at the glazing edge, and the glazing edge lengths are included in these heat losses. A more detailed report of the calculations performed in the context of certification is available from the manufacturer.

The Passive House Institute has defined international component criteria for seven climate zones. In principle, components which have been certified for climate zones with higher requirements may also be used in climates with less stringent requirements. In a particular climate zone it may make sense to use a component of a higher thermal quality which has been certified for a climate zone with more stringent requirements.

Further information relating to certification can be found on www.passivehouse.com and passipedia.org.

Frame values			Frame width b_f mm	U -value frame U_f W/(m ² K)	Ψ -glazing edge Ψ_g W/(m K)	Temp. Factor $f_{Rsi=0.25}$ [-]
Mullion fixed	(0M1)		104	0.97	0.024	0.72
Mullion 1 casement	(1M1)		144	1.06	0.024	0.70
Mullion 2 casements	(2M1)		184	1.11	0.023	0.69
Bottom fixed	(FB1)		82	0.78	0.024	0.72
Top fixed	(FH1)		82	0.78	0.024	0.72
Lateral fixed	(FJ1)		82	0.78	0.024	0.72
Flying Mullion	(FM1)		165	1.07	0.022	0.69
Bottom	(OB1)		122	0.99	0.023	0.71
Top	(OH1)		122	0.98	0.023	0.71
Lateral	(OJ1)		122	0.98	0.023	0.71
Threshold	(OT1)		90	1.83	0.022	0.51

Spacer: SWISSPACER ULTIMATE Secondary seal: Silicone



Mullion fixed

$b_f = 104 \text{ mm}$
 $U_f = 0.97 \text{ W/(m}^2 \text{ K)}$
 $\Psi_g = 0.024 \text{ W/(m K)}$
 $f_{Rsi} = 0.72$

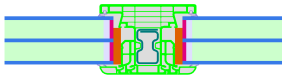
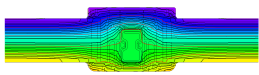

Mullion 1 casement

$b_f = 144 \text{ mm}$
 $U_f = 1.06 \text{ W/(m}^2 \text{ K)}$
 $\Psi_g = 0.024 \text{ W/(m K)}$
 $f_{Rsi} = 0.70$



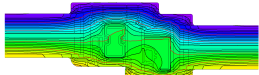



Mullion

2 casements

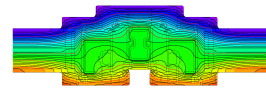
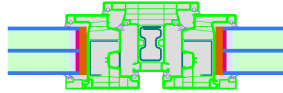
$$b_f = 184 \text{ mm}$$
$$U_f = 1.11 \text{ W}/(\text{m}^2 \text{ K})$$
$$\Psi_g = 0.023 \text{ W}/(\text{m K})$$
$$f_{Rsi} = 0.69$$



Bottom

fixed

$$b_f = 82 \text{ mm}$$
$$U_f = 0.78 \text{ W}/(\text{m}^2 \text{ K})$$
$$\Psi_g = 0.024 \text{ W}/(\text{m K})$$
$$f_{Rsi} = 0.72$$

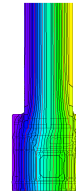
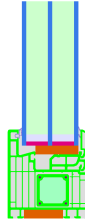

Top

fixed

$$b_f = 82 \text{ mm}$$
$$U_f = 0.78 \text{ W}/(\text{m}^2 \text{ K})$$
$$\Psi_g = 0.024 \text{ W}/(\text{m K})$$
$$f_{Rsi} = 0.72$$

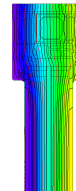
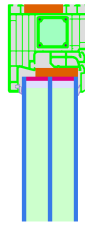

Lateral

fixed

$$b_f = 82 \text{ mm}$$
$$U_f = 0.78 \text{ W}/(\text{m}^2 \text{ K})$$
$$\Psi_g = 0.024 \text{ W}/(\text{m K})$$
$$f_{Rsi} = 0.72$$

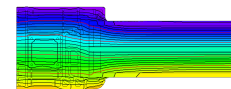
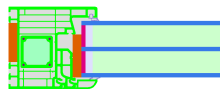

Flying Mullion

$$b_f = 165 \text{ mm}$$
$$U_f = 1.07 \text{ W}/(\text{m}^2 \text{ K})$$
$$\Psi_g = 0.022 \text{ W}/(\text{m K})$$
$$f_{Rsi} = 0.69$$

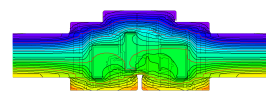



Bottom

$b_f = 122 \text{ mm}$
 $U_f = 0.99 \text{ W/(m}^2 \text{ K)}$
 $\Psi_g = 0.023 \text{ W/(m K)}$
 $f_{Rsi} = 0.71$

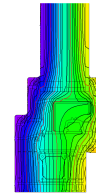
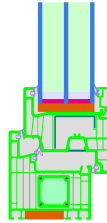

Top

$b_f = 122 \text{ mm}$
 $U_f = 0.98 \text{ W/(m}^2 \text{ K)}$
 $\Psi_g = 0.023 \text{ W/(m K)}$
 $f_{Rsi} = 0.71$

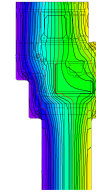

Lateral

$b_f = 122 \text{ mm}$
 $U_f = 0.98 \text{ W/(m}^2 \text{ K)}$
 $\Psi_g = 0.023 \text{ W/(m K)}$
 $f_{Rsi} = 0.71$

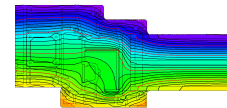
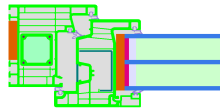

Threshold

$b_f = 90 \text{ mm}$
 $U_f = 1.83 \text{ W/(m}^2 \text{ K)}$
 $\Psi_g = 0.022 \text{ W/(m K)}$
 $f_{Rsi} = 0.51$

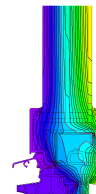
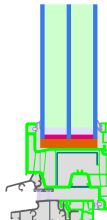

Validated installations

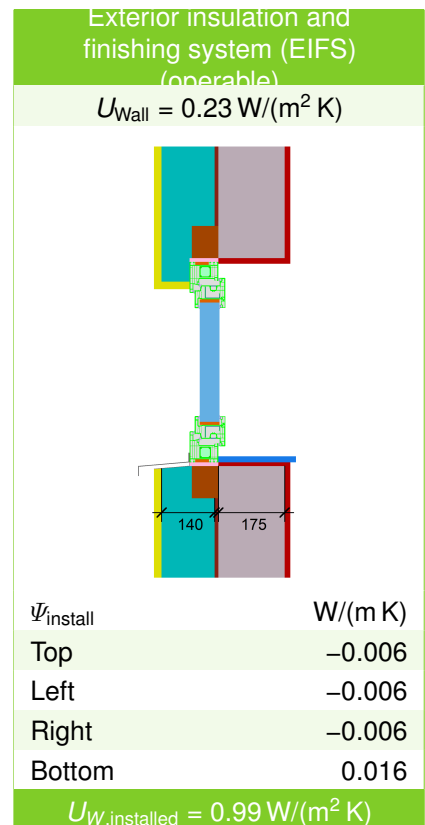
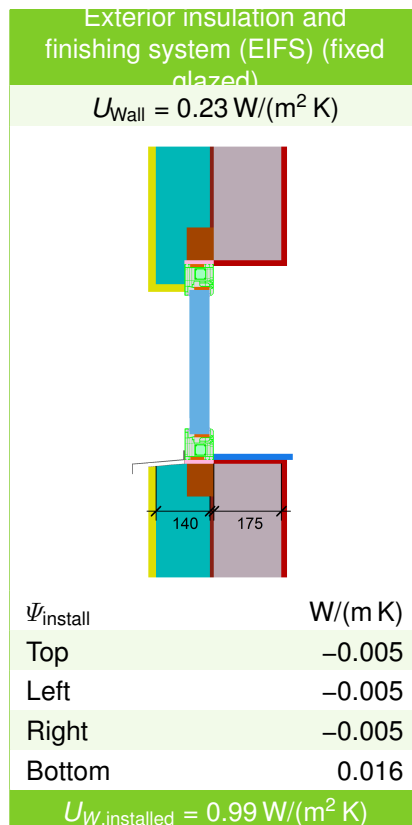
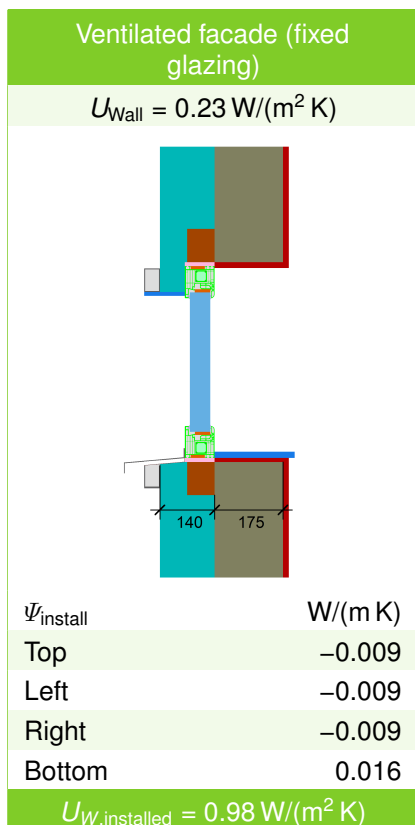
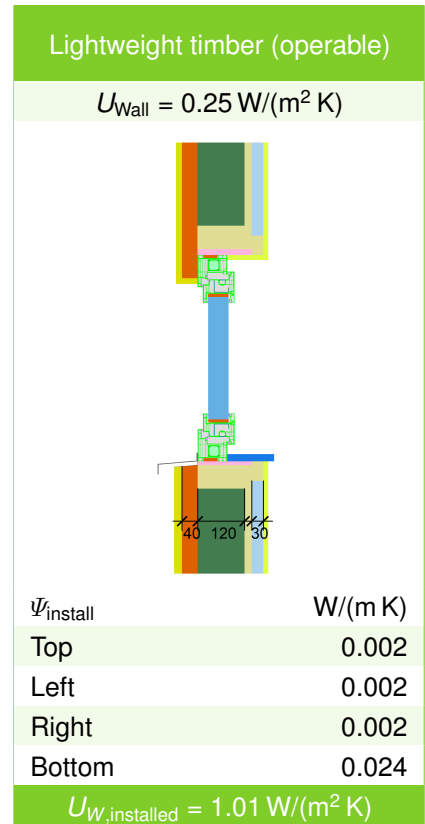
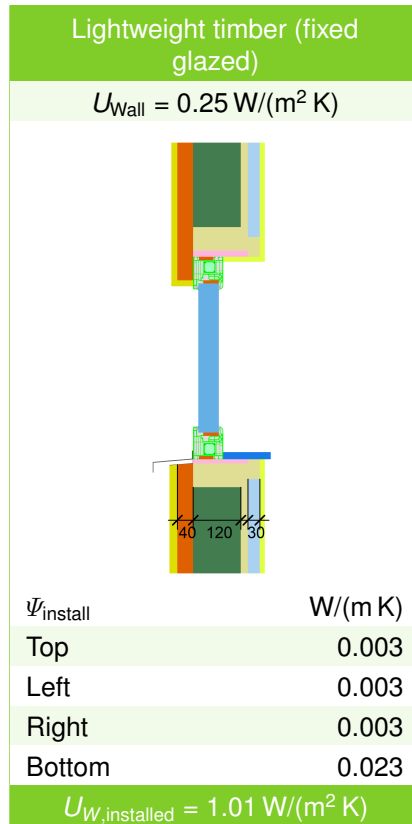
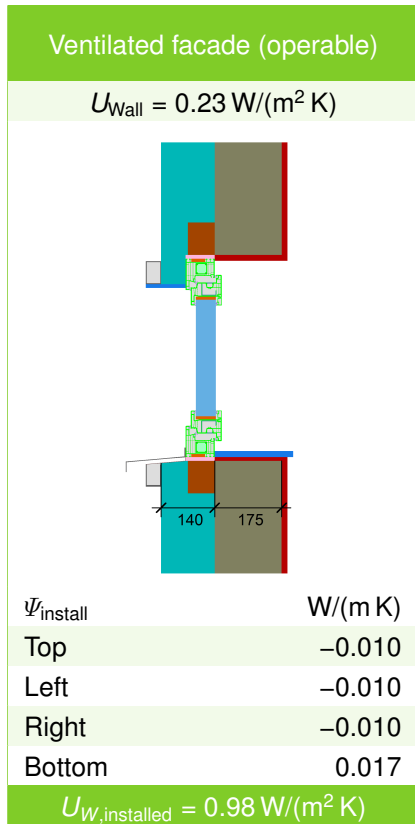

Ext insulation a. finish. s. (EIFS)
threshold ceiling (operable)

$$U_1 = 0.23 \text{ [W/(m}^2 \text{ K)]}$$

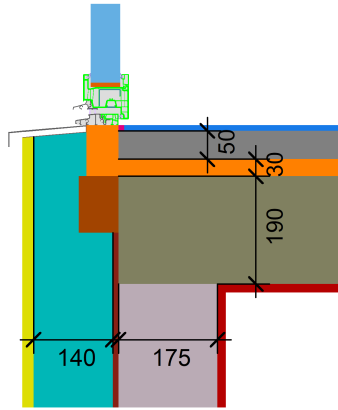

$$\Psi_{\text{install}} = 0.05 \text{ W/(m K)}$$

