

CERTIFICATE

Certified Passive House Component

Component-ID 2393wi03 valid until 31st December 2025

Passive House Institute
Dr. Wolfgang Feist
64283 Darmstadt
Germany

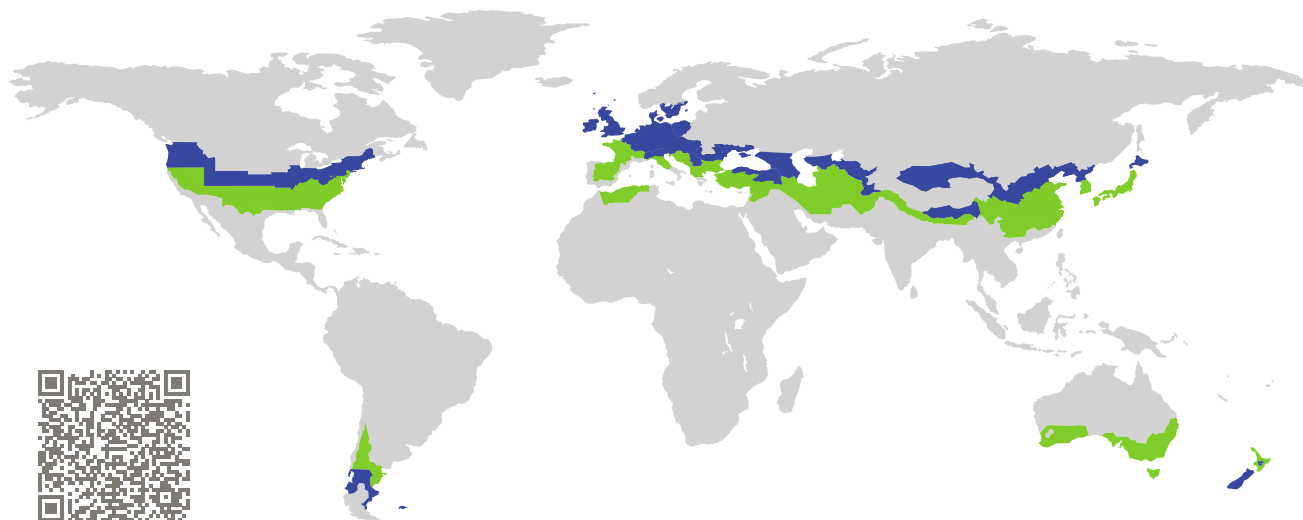

Category: **Window Frame**
Manufacturer: **Duxton Windows & Doors,
Winnipeg,
Canada**
Product name: **458AW Awning**

**This certificate was awarded based on the following
criteria for the cool, temperate climate zone**

Comfort $U_W = 0.79 \leq 0.80 \text{ W}/(\text{m}^2 \text{ K})$
 $U_{W,\text{installed}} \leq 0.85 \text{ W}/(\text{m}^2 \text{ K})$
with $U_g = 0.70 \text{ W}/(\text{m}^2 \text{ K})$

Hygiene $f_{Rsi=0.25} \geq 0.70$

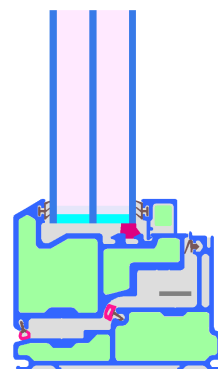

cool, temperate climate



**CERTIFIED
COMPONENT**

Passive House Institute

Passive House
efficiency class

phE

phD

phC

phB

phA

www.passivehouse.com

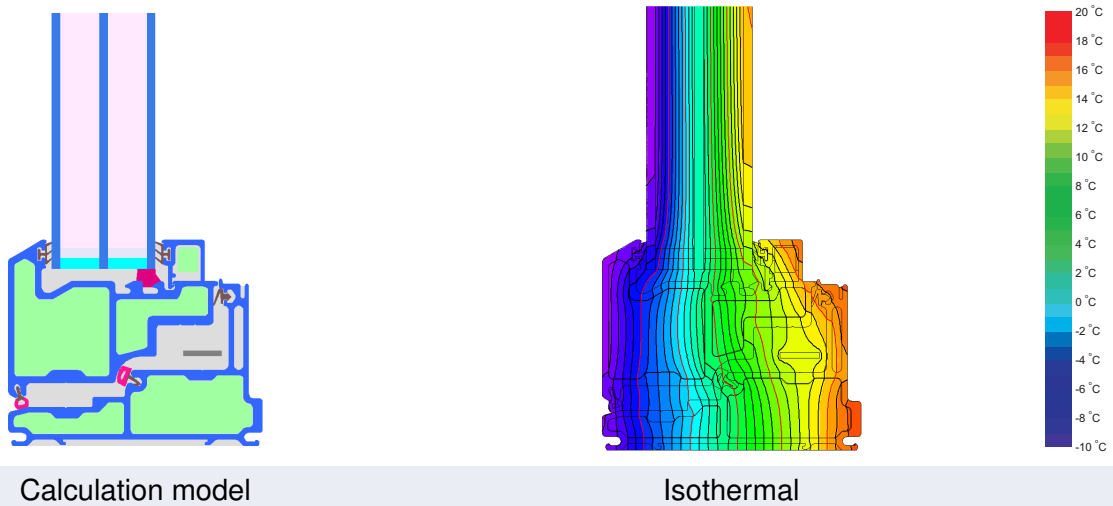

Description

Fiberglass frame insulated by graphite polystyrene foam (0.031W/m.K). Pane thickness: 48 mm (4/18/4/18/4), rebate depth: 13,5 mm. In case a smaller noble gas gap than 16 mm is used, a U_g value of 0.54 W/m²K is necessary to achieve sufficient surface temperatures for the fixed part of the mullion.

Explanation

The window U-values were calculated for the test window size of 1.23 m × 1.48 m with $U_g = 0.70$ W/(m² K). If a higher quality glazing is used, the window U-values will improve as follows:

Glazing	$U_g =$	0.70	0.64	0.58	0.52	W/(m ² K)
		↓	↓	↓	↓	
Window	$U_W =$	0.79	0.75	0.70	0.66	W/(m ² K)





Transparent building components are classified into efficiency classes depending on the heat losses through the opaque part. The frame U-Values, frame widths, thermal bridges at the glazing edge, and the glazing edge lengths are included in these heat losses. A more detailed report of the calculations performed in the context of certification is available from the manufacturer.

The Passive House Institute has defined international component criteria for seven climate zones. In principle, components which have been certified for climate zones with higher requirements may also be used in climates with less stringent requirements. In a particular climate zone it may make sense to use a component of a higher thermal quality which has been certified for a climate zone with more stringent requirements.

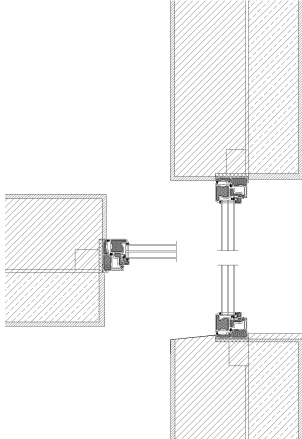
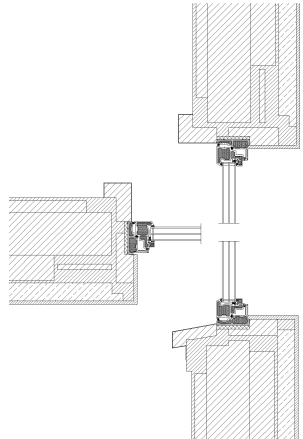
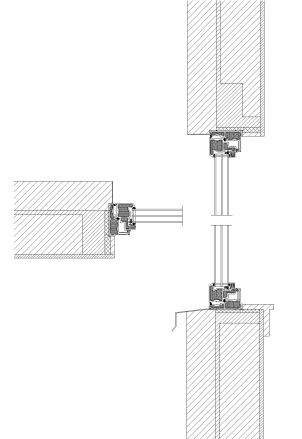
Further information relating to certification can be found on www.passivehouse.com and passipedia.org.

Validated installations

Exterior insulation and finishing system (EIFS) (operable)		Lightweight timber (operable)		Solid timber (operable)	
$U_{\text{Wall}} = 0.13 \text{ W}/(\text{m}^2 \text{ K})$		$U_{\text{Wall}} = 0.14 \text{ W}/(\text{m}^2 \text{ K})$		$U_{\text{Wall}} = 0.15 \text{ W}/(\text{m}^2 \text{ K})$	
					
Ψ_{install}	W/(m K)	Ψ_{install}	W/(m K)	Ψ_{install}	W/(m K)
Top	0.014	Top	0.015	Top	0.019
Side	0.015	Side	0.015	Side	0.016
Bottom	0.010	Bottom	0.014	Bottom	0.015
$U_{W,\text{installed}} = 0.83 \text{ W}/(\text{m}^2 \text{ K})$		$U_{W,\text{installed}} = 0.84 \text{ W}/(\text{m}^2 \text{ K})$		$U_{W,\text{installed}} = 0.84 \text{ W}/(\text{m}^2 \text{ K})$	

Frame values		Frame width b_f mm	U -value frame U_f W/(m ² K)	Ψ -glazing edge Ψ_g W/(m K)	Temp. Factor $f_{Rsi=0.25}$ [-]
Mullion 1 casement	(1M1) 	137	0.90	0.024	0.68
Bottom	(OB1) 	95	0.82	0.023	0.72
Top	(OH1) 	95	0.82	0.023	0.72
Lateral	(OJ1) 	95	0.83	0.023	0.72
Spacer: Super Spacer Premium			Secondary seal: Butyl		

